

Westwood electrodes & insulators
 HIGH DIELECTRIC STRENGTH • PRECISION DIMENSIONS

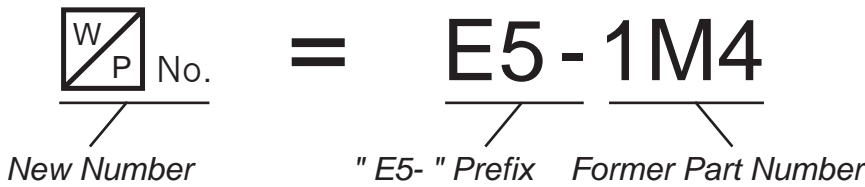

NOTE: Electrode and related items part numbers are now "E5-" followed by the former number.

Example:



Type 1M

Insulator length	W/P No.
4"	E5-1M4
4-1/4"	E5-1M4-1/4
4-1/2"	E5-1M4-1/2
5"	E5-1M5
6"	E5-1M6
7"	E5-1M7
8"	E5-1M8

Type 2M

Insulator length	W/P No.
4"	E5-2M4
4-1/2"	E5-2M4-1/2
5"	E5-2M5
5-1/2"	E5-2M5-1/2
6"	E5-2M6
7"	E5-2M7
8"	E5-2M8

Type 3M

Insulator length	W/P No.
4"	E5-3M4
4-1/2"	E5-3M4-1/2
5"	E5-3M5
5-1/2"	E5-3M5-1/2
6"	E5-3M6
7"	E5-3M7
8"	E5-3M8

Type 4M

Insulator length	W/P No.
4"	E5-4M4
4-1/4"	E5-4M4-1/4
4-1/2"	E5-4M4-1/2
5"	E5-4M5
6"	E5-4M6
7"	E5-4M7
8"	E5-4M8

Type 5M

Insulator length	W/P No.
4"	E5-5M4
5"	E5-5M5
6"	E5-5M6

Type 2F

Insulator length	W/P No.
4"	E5-2F4
4-1/2"	E5-2F4-1/2
5"	E5-2F5
5-1/2"	E5-2F5-1/2
6"	E5-2F6
7"	E5-2F7
8"	E5-2F8

Type 3F

Insulator length	W/P No.
4"	E5-3F4
4-1/2"	E5-3F4-1/2
5"	E5-3F5
5-1/2"	E5-3F5-1/2
6"	E5-3F6
7"	E5-3F7
8"	E5-3F8

Note: To order the insulator only for any electrode found on this page, add "INS" to the part number.

Westwood electrodes & insulators

HIGH DIELECTRIC STRENGTH • PRECISION DIMENSIONS

<p>Ace "A" E5-100 Ace 5" E5-100B Ace 6" E5-100C Ace 7" E5-100C</p>	<p>Arco E5-124</p> <p>Arco E5-126</p>	<p>ABC 6" E5-144A ABC 5" E5-144B ABC 4-1/2" E5-144C ABC 4" E5-144D ABC 3" E5-144E ABC 2" E5-144F ABC 1-3/4" E5-144G ABC None E5-144H</p>
<p>Ace E5-100A</p>	<p>Arco E5-127</p>	<p>ABC E5-146</p>
<p>Acme E5-102A</p>	<p>Arco E5-127A</p>	<p>ABC E5-146A ABC none E5-146B ABC 4-1/2" E5-146C</p>
<p>Acme E5-102B</p>	<p>Armstrong E5-128</p>	<p>ABC E5-147</p>
<p>Acme E5-107</p>	<p>ABC (with bracket) E5-130</p>	<p>ABC E5-148</p>
<p>Aeroil E5-108</p>	<p>Aero E5-109</p>	<p>ABC E5-148A</p>
<p>Aero E5-110</p>	<p>ABC (with bracket) E5-130A</p>	<p>ABC E5-148B</p>
<p>Aero E5-110B</p>	<p>ABC "A" E5-131A ABC 4" E5-132A ABC 5" E5-132A</p>	<p>ABC E5-148C</p>
<p>Alcoa E5-111</p>	<p>ABC "A" E5-131 ABC 4" E5-132 ABC 5" E5-132</p>	<p>ABC E5-148D</p>
<p>Aero "A" E5-111A Aero none E5-111D Aero 9-1/2" E5-111E Aero 13-1/2" E5-111F Aero 4-3/4" E5-111G Aero 7-1/2" E5-111G</p>	<p>ABC "A" E5-131 ABC 4" E5-132 ABC 5" E5-132</p>	<p>ABC E5-148E</p>
<p>Arco E5-121</p>	<p>ABC E5-133</p>	<p>ABC E5-148F</p>
<p>Arco E5-122</p>	<p>ABC "A" E5-137B ABC 4-1/4" E5-137C ABC 7-1/2" E5-137E</p>	<p>ABC E5-148H</p>
<p>Arco E5-123</p>	<p>ABC E5-148J</p>	<p>ABC E5-148K</p>

Westwood electrodes & insulators

HIGH DIELECTRIC STRENGTH • PRECISION DIMENSIONS

<p>ABC E5-148M</p>	<p>Beckett E5-151L</p>	<p>Beckett AF II HLX E5-151Z</p>
<p>ABC Sunray OE-1 E5-148Q</p>	<p>Beckett E5-151M</p>	<p>Beckett AF 15 E5-152B</p>
<p>ABC Sunray "A" "B" "C" ABC Sunray 7/16" 3-1/4" 3/4" E5-148R ABC Sunray 7/16" 4-1/4" 1/4" E5-148R1 ABC Sunray 15/16" 3-1/4" 3/4" E5-148S</p>	<p>Beckett E5-151N</p>	<p>Beckett AF II FBX E5-152C</p>
<p>Beckett E5-151A</p>	<p>Beckett E5-151O</p>	<p>Bethlehem E5-156</p>
<p>Beckett E5-151B</p>	<p>Beckett E5-151P Beckett 5" E5-151P1 Beckett 2" E5-151P1 Beckett 3/4" E5-151P2</p>	<p>Bettendorf E5-157</p>
<p>Beckett E5-151C</p>	<p>Beckett E5-151Q Beckett (without spring) E5-151Q1</p>	<p>Bettendorf E5-160</p>
<p>Beckett E5-151D</p>	<p>Beckett E5-151R Beckett 2-7/16" E5-151R-1 Beckett 5" E5-151R-1 Beckett 3" E5-151R-2 Beckett none E5-151R-3 Beckett 6-3/4" E5-151R-4</p>	<p>Bettendorf E5-160A</p>
<p>Beckett E5-151E</p>	<p>Beckett E5-151E1</p>	<p>Bettendorf E5-160B</p>
<p>Beckett E5-151F</p>	<p>Beckett E5-151S Beckett 6-3/4" E5-151T Beckett 13-3/4" E5-151T</p>	<p>Bettendorf E5-160C</p>
<p>Beckett E5-151G</p>	<p>Beckett E5-151U</p>	<p>Bettendorf E5-160D</p>
<p>Beckett E5-151H</p>	<p>Beckett E5-151V</p>	<p>Bettendorf E5-160E</p>
<p>Beckett E5-151I</p>	<p>Beckett E5-151X</p>	<p>Blueray E5-1880</p>
<p>Beckett E5-151J</p>	<p>Beckett E5-151K</p>	<p>Bock E5-161B</p>
<p>Beckett E5-151K</p>	<p>Bock E5-161C</p>	<p>Bock E5-161C</p>

Westwood electrodes & insulators

HIGH DIELECTRIC STRENGTH • PRECISION DIMENSIONS

 Branford E5-170	 Carlin E5-188D	 Carlin E5-188P
 Carlin E5-184	 Carlin E5-188E	 Carlin E5-188Q
 "A" 9/16" Carlin 4" E5-184A Carlin 5" E5-184B Carlin 6" E5-184C	 Carlin E5-188F	 "B" 3-1/4" A 7/16"
 Carlin E5-185	 Carlin E5-188G	 "A" "B" 7/8" 12" E5-188R2 1-9/16" 12" E5-188R3 7/8" 15" E5-188R4
 Carlin E5-185A	 Carlin E5-188H	 Century E5-189
 Carlin E5-186	 Carlin LH/RH E5-188I	 Century E5-190
 Carlin E5-186	 Carlin LH/RH E5-188J	 Century E5-191
 Carlin E5-187	 Carlin E5-188K	 Century E5-191A
 Carlin E5-187A	 Carlin E5-188L	 Century E5-191B
 "A" 9/16" Carlin 5" E5-187B Carlin 6" E5-187C	 Carlin E5-188M	 Chief E5-192
 Carlin E5-188	 Carlin 7/8" E5-188N Carlin 1-9/16" E5-188N2	 Chief E5-192B
 Carlin E5-188A	 "A" 3-1/4" 7/16" Carlin 2-1/2" Heavy Tip E5-188N1 Carlin 11" E5-188N3 Carlin 1-1/2" E5-188N5 Carlin 8-1/2" E5-188N6 Carlin 4-1/2" E5-188N8 Carlin 6-1/2" E5-188N9	 Chrysler E5-193
 Carlin 7/8" E5-188B Carlin 1-9/16" E5-188B2	 "A" 3-1/4" 7/16" Carlin 8-1/2" Light Tip E5-188N4 Carlin 4-1/2" E5-188N7 Carlin 6-1/2" E5-188N10	 Chrysler E5-195
 Carlin E5-188C	 Carlin E5-188O	 Clayton E5-198
		 Clayton E5-199
		 Clayton E5-199A

Please order by No.

Westwood electrodes & insulators





HIGH DIELECTRIC STRENGTH • PRECISION DIMENSIONS

<p>Clayton E5-199C</p>	<p>Cleaver Brooks</p>	<p>Columbia Boiler E5-207</p>												
<p>Clayton E5-199D</p>	<table border="0"> <tr> <td>E5-205F 21</td> <td>E5-205J 24</td> <td>E5-205O 12</td> </tr> <tr> <td>E5-205G 18-1/4</td> <td>E5-205K 27</td> <td>E5-205Q 30</td> </tr> <tr> <td>E5-205H 19-3/4</td> <td>E5-205L 14</td> <td></td> </tr> <tr> <td>E5-205I 15-3/4</td> <td>E5-205M 27-1/2</td> <td></td> </tr> </table>	E5-205F 21	E5-205J 24	E5-205O 12	E5-205G 18-1/4	E5-205K 27	E5-205Q 30	E5-205H 19-3/4	E5-205L 14		E5-205I 15-3/4	E5-205M 27-1/2		<p>Columbia Boiler E5-207A</p>
E5-205F 21	E5-205J 24	E5-205O 12												
E5-205G 18-1/4	E5-205K 27	E5-205Q 30												
E5-205H 19-3/4	E5-205L 14													
E5-205I 15-3/4	E5-205M 27-1/2													
<p>Cleanburn E5-199Z</p>	<p>Cleaver Brooks E5-205N</p>	<p>Columbia Boiler E5-213 E5-214</p>												
<p>Cleanburn E5-199Z1</p>	<p>Cleaver Brooks E5-205R</p>	<p>Crane Crane E5-213 none E5-214 6"</p>												
<p>Cleaver Brooks E5-201</p>	<p>Cleaver Brooks E5-205T</p>	<p>Delco E5-220</p>												
<p>Cleaver Brooks E5-203</p>	<p>Cleaver Brooks E5-205U</p>	<p>Delco E5-221</p>												
<p>Cleaver Brooks E5-204A</p>	<p>Cleaver Brooks E5-205V</p>	<p>Delco E5-224</p>												
<p>Cleaver Brooks E5-205</p>	<p>Cleaver Brooks E5-205W</p>	<p>Delco E5-225</p>												
<p>Cleaver Brooks E5-205A Cleaver Brooks E5-205A5</p>	<p>Cleaver Brooks E5-205X</p>	<p>Delco E5-226</p>												
<p>Cleaver Brooks E5-205Y</p>	<p>Cleaver Brooks E5-205Z</p>	<p>Delco E5-227</p>												
<p>Cleaver Brooks E5-205A1</p>	<p>Cleaver Brooks E5-205Z2</p>	<p>Delco E5-228</p>												
<p>Cleaver Brooks E5-205A2</p>	<p>Cleaver Brooks E5-205Z3</p>	<p>Delco E5-231</p>												
<p>Cleaver Brooks E5-205B</p>	<p>Coleman E5-202A</p>	<p>Dravo E5-232</p>												
<p>Cleaver Brooks E5-205D Cleaver Brooks E5-205E Cleaver Brooks E5-205E2</p>	<p>Coleman E5-202B</p>	<p>Dravo E5-232A Dravo E5-232B</p>												
<p>Columbia Boiler E5-206</p>	<p>Dravo E5-232C</p>													

E5

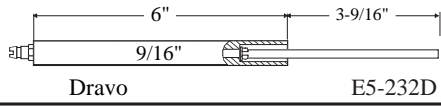
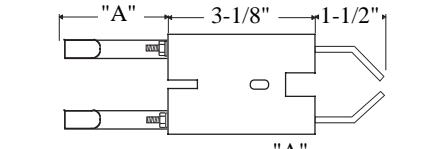
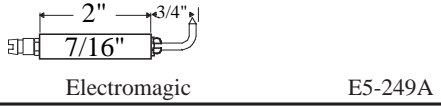
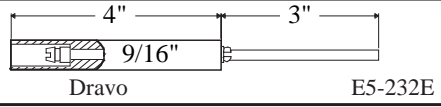
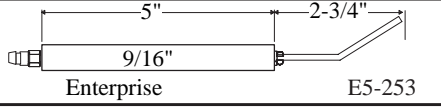
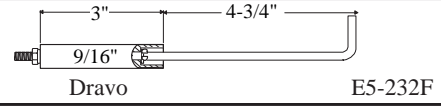
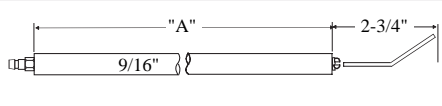
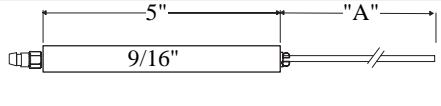
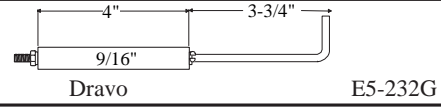
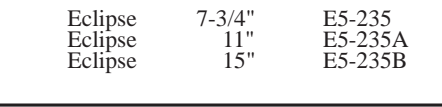
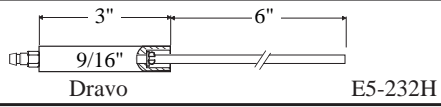
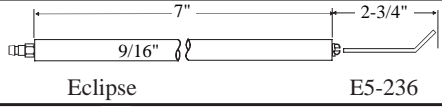
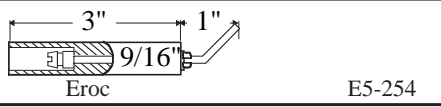
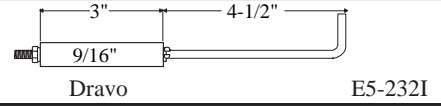
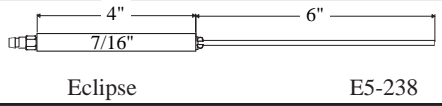
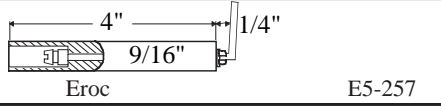
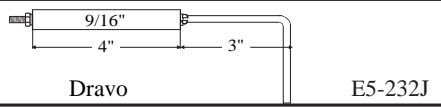
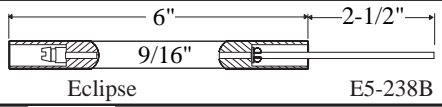
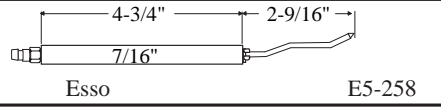
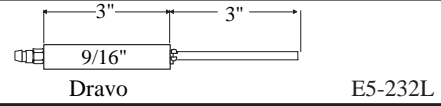

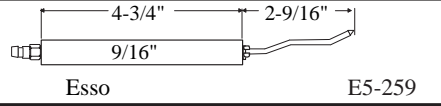
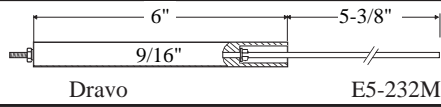
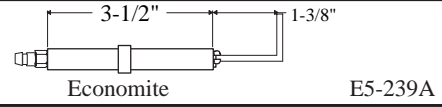
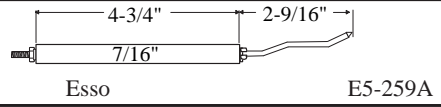
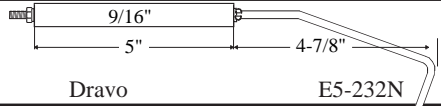

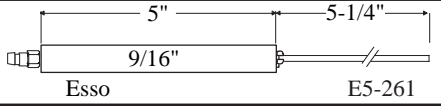
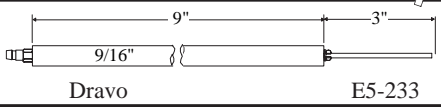
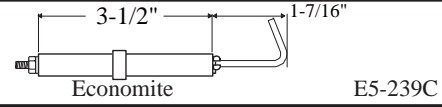
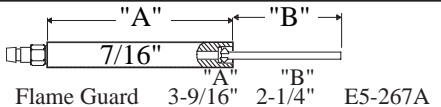
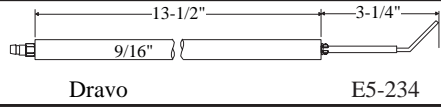
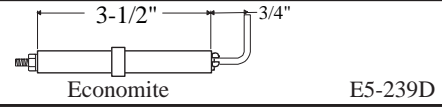
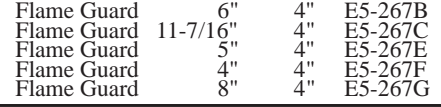
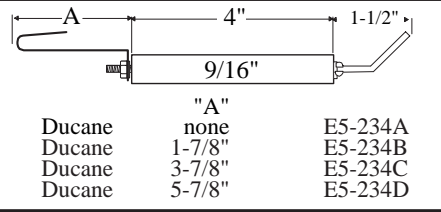
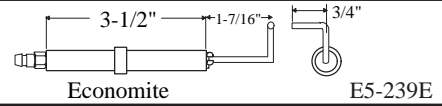
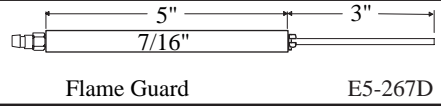
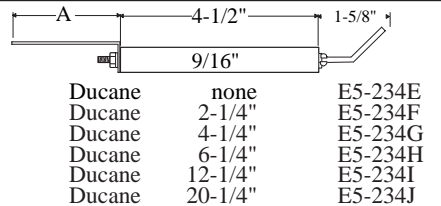
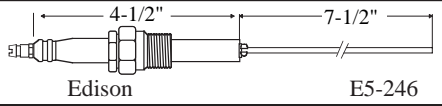
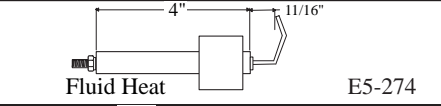
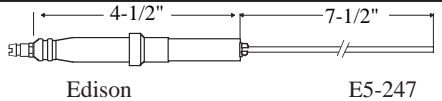
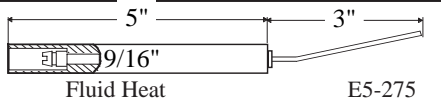



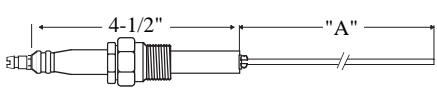
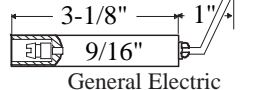
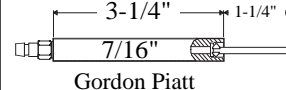
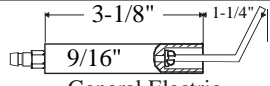
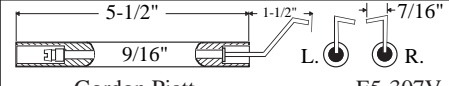
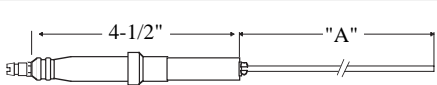
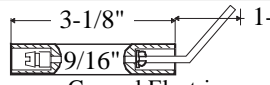

Westwood electrodes & insulators

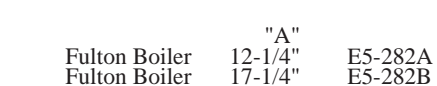
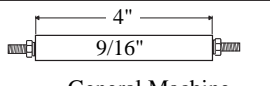
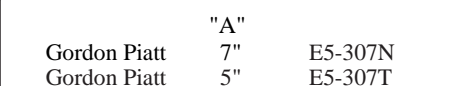
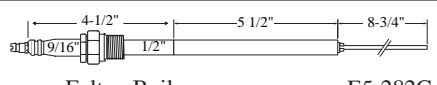
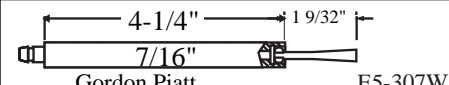
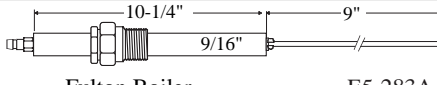
HIGH DIELECTRIC STRENGTH • PRECISION DIMENSIONS

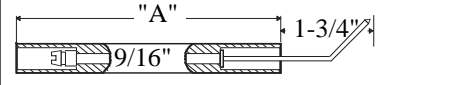
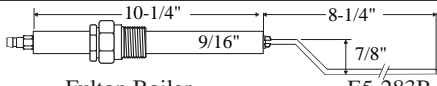
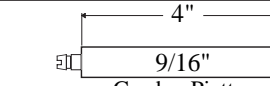
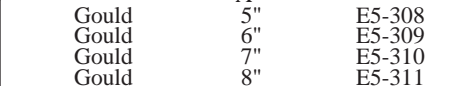
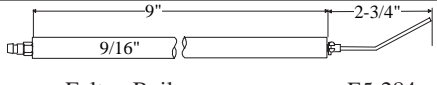
 Dravo E5-232D	 "A" 3-1/8" 1-1/2" Ducane OilMaster™ 2-3/4" E5-234L Ducane OilMaster™ 4-3/4" E5-234M	 Electromagic E5-249A
 Dravo E5-232E		 Enterprise E5-253
 Dravo E5-232F	 "A" 2-3/4" 9/16"	 Enterprise "A" 5" E5-253B Enterprise 1-3/4" E5-253C Enterprise 2-1/2" E5-253D
 Dravo E5-232G	 Eclipse 7-3/4" E5-235 Eclipse 11" E5-235A Eclipse 15" E5-235B	
 Dravo E5-232H	 Eclipse 7" 2-3/4" 9/16"	 Eroc 3" 1" 9/16" E5-254
 Dravo E5-232I	 Eclipse 4" 6" 2-1/2" 7/16" 9/16"	 Eroc 4" 1/4" 9/16" E5-257
 Dravo E5-232J	 Eclipse 6" 2-1/2" 9/16"	 Esso 4-3/4" 2-9/16" 7/16" E5-258
 Dravo E5-232L	 Economite 2-9/16" L. R. E5-239	 Esso 4-3/4" 2-9/16" 9/16" E5-259
 Dravo E5-232M	 Economite 3-1/2" 1-3/8" E5-239A	 Esso 4-3/4" 2-9/16" 7/16" E5-259A
 Dravo E5-232N	 Economite 2-9/16" 1/2" E5-239B	 Esso 5" 5-1/4" 9/16" E5-261
 Dravo E5-233	 Economite 3-1/2" 1-7/16" E5-239C	 "A" "B" 7/16" "A" "B" Flame Guard 3-9/16" 2-1/4" E5-267A Flame Guard 6" 4" E5-267B Flame Guard 11-7/16" 4" E5-267C Flame Guard 5" 4" E5-267E Flame Guard 4" 4" E5-267F Flame Guard 8" 4" E5-267G
 Dravo E5-234	 Economite 3-1/2" 3/4" E5-239D	 Flame Guard 5" 3" 7/16" E5-267D
 "A" 4" 1-1/2" 9/16" Ducane none E5-234A Ducane 1-7/8" E5-234B Ducane 3-7/8" E5-234C Ducane 5-7/8" E5-234D	 Economite 3-1/2" 1-7/16" 3/4" E5-239E	 Fluid Heat 4-1/2" 2-7/16" L. R. 9/16" E5-273
 "A" 4-1/2" 1-5/8" 9/16" Ducane none E5-234E Ducane 2-1/4" E5-234F Ducane 4-1/4" E5-234G Ducane 6-1/4" E5-234H Ducane 12-1/4" E5-234I Ducane 20-1/4" E5-234J	 Edison 4-1/2" 7-1/2" E5-246	 Fluid Heat 4" 11/16" E5-274
	 Edison 4-1/2" 7-1/2" E5-247	 Fluid Heat 5" 3" 9/16" E5-275

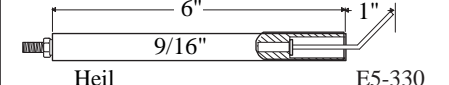
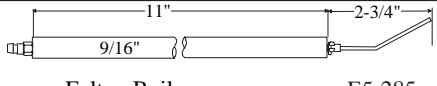

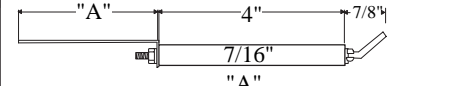
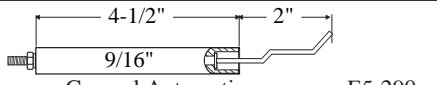
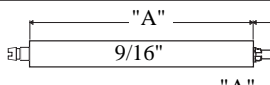
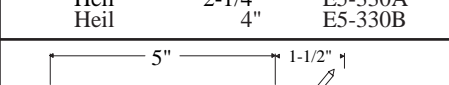
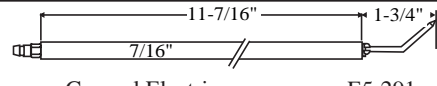

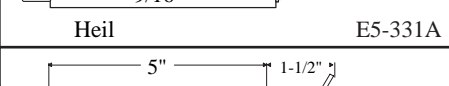
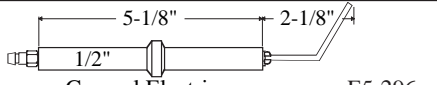
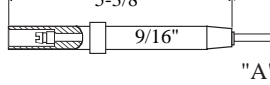
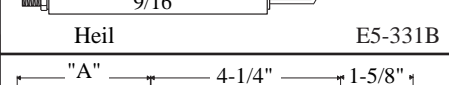
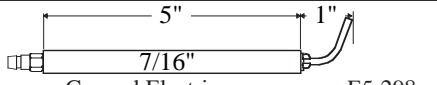
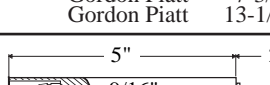
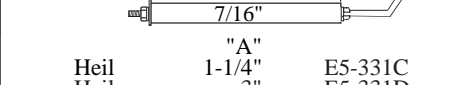





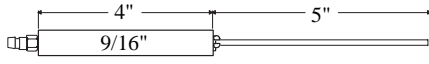
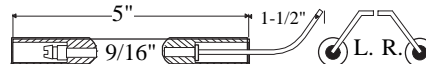
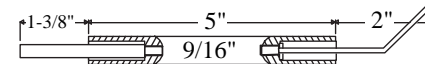
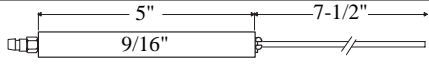
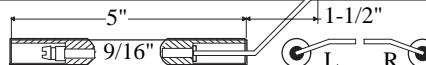
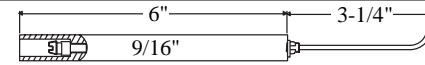
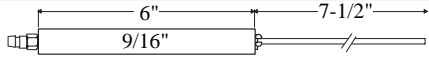
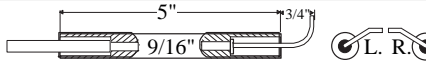

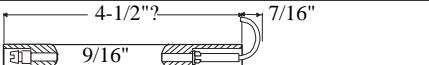
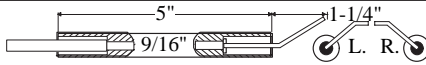
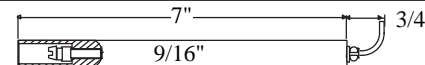
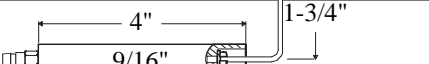
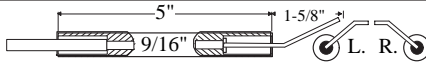
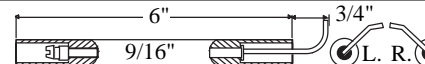
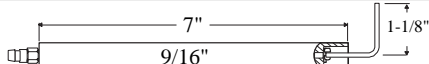
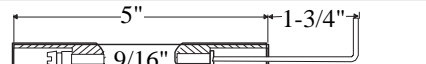
Westwood electrodes & insulators

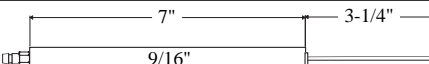
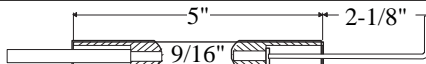
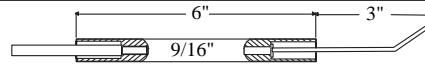
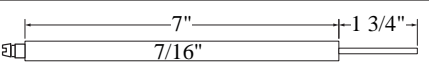
HIGH DIELECTRIC STRENGTH • PRECISION DIMENSIONS

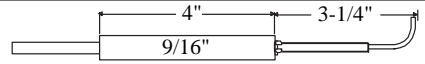
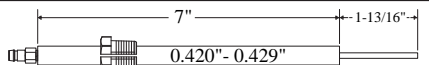
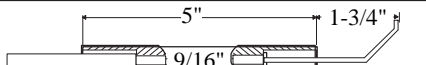
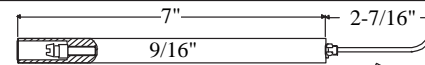
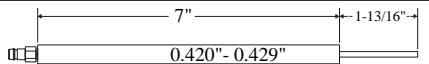
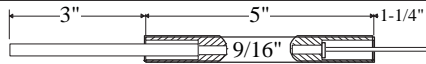
 <p>Fulton Boiler Fulton Boiler</p> <p>"A" 12-1/4" 17-1/4"</p> <p>E5-282 E5-283</p>	 <p>General Electric E5-301</p>	 <p>Gordon Piatt E5-307U</p>
<p>Fulton Boiler Fulton Boiler</p> <p>"A" 12-1/4" 17-1/4"</p> <p>E5-282 E5-283</p>	 <p>General Electric E5-301A</p>	 <p>Gordon Piatt E5-307V</p>
 <p>Fulton Boiler Fulton Boiler</p> <p>"A" 12-1/4" 17-1/4"</p> <p>E5-282A E5-282B</p>	 <p>General Electric E5-301B</p>	 <p>Gordon Piatt Gordon Piatt</p> <p>"A" 7" 5"</p> <p>E5-307N E5-307T</p>
 <p>Fulton Boiler E5-282C</p>	 <p>General Machine E5-303</p>	 <p>Gordon Piatt E5-307W</p>
 <p>Fulton Boiler E5-283A</p>	<p>Gold Star Gold Star</p> <p>"A" 4" 5"</p> <p>E5-306 E5-307</p>	 <p>Gould Gould Gould Gould</p> <p>"A" 5" 6" 7" 8"</p> <p>E5-308 E5-309 E5-310 E5-311</p>
 <p>Fulton Boiler E5-283B</p>	 <p>Gordon Piatt E5-307A</p>	 <p>Heil E5-330</p>
 <p>Fulton Boiler E5-284</p>	 <p>Gordon Piatt Gordon Piatt Gordon Piatt</p> <p>"A" 5" 7" 9"</p> <p>E5-307B E5-307C E5-307D</p>	 <p>Heil Heil</p> <p>"A" 2-1/4" 4"</p> <p>E5-330A E5-330B</p>
 <p>Fulton Boiler E5-285</p>	 <p>General Automatic E5-290</p>	 <p>Heil E5-331A</p>
 <p>General Electric E5-291</p>	 <p>Gordon Piatt Gordon Piatt Gordon Piatt Gordon Piatt</p> <p>"A" 4" 5" 6" 8"</p> <p>E5-307F E5-307P E5-307G E5-307H</p>	 <p>Heil E5-331B</p>
 <p>General Electric E5-296</p>	 <p>Gordon Piatt E5-307K</p>	 <p>Heil Heil</p> <p>"A" 1-1/4" 3"</p> <p>E5-331C E5-331D</p>
 <p>General Electric E5-298</p>	 <p>Gordon Piatt E5-307O</p>	 <p>Homelite E5-337A</p>
 <p>General Electric E5-299</p>	 <p>Gordon Piatt Gordon Piatt Gordon Piatt</p> <p>"A" 4" 6" 8"</p> <p>E5-307Q E5-307R E5-307S</p>	 <p>Homestead E5-338</p>
 <p>General Electric E5-299A</p>	 <p>General Electric E5-300</p>	 <p>Hupp E5-339</p>

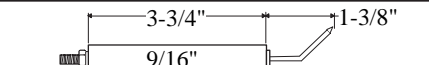
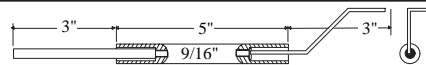
Westwood electrodes & insulators

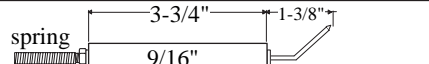
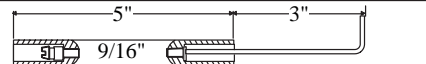
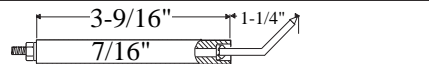
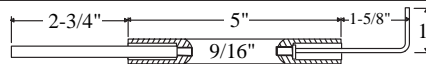
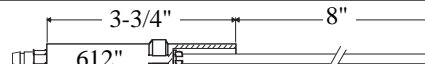
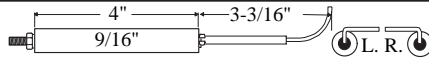
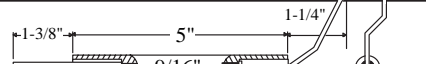
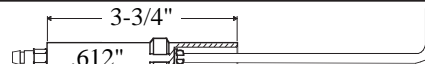
HIGH DIELECTRIC STRENGTH • PRECISION DIMENSIONS

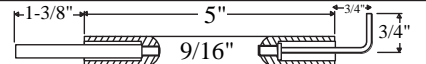
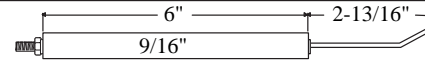
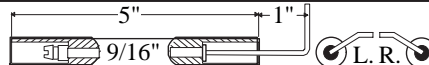
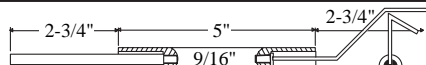
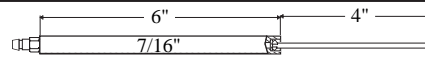
 Homestead E5-340	 Iron Fireman E5-357B	 Iron Fireman E5-357Y
 Homestead E5-341	 Iron Fireman E5-357C	 Iron Fireman E5-358
 Homestead E5-341A	 Iron Fireman E5-357D	 Iron Fireman E5-363
 Industrial Combustion E5-342	 Iron Fireman E5-357E	 Iron Fireman E5-364
 Industrial Combustion E5-343	 Iron Fireman E5-357F	 Iron Fireman E5-365
 Industrial Combustion E5-343A	 Iron Fireman E5-357I	 Iron Fireman E5-365B
 Industrial Combustion E5-344	 Iron Fireman E5-357J	 Iron Fireman E5-365D
 Industrial Combustion E5-344A	 Iron Fireman E5-357K	 Iron Fireman E5-366
 Industrial Combustion E5-345	 Iron Fireman E5-357L	 Iron Fireman E5-366A
 Industrial Combustion E5-345A	 Iron Fireman E5-357M	 Iron Fireman E5-366D
 International E5-348	 Iron Fireman E5-357N	 Johnson E5-371
 International E5-348A	 Iron Fireman E5-357O	Johnson 1-1/2" E5-371 Johnson 2" E5-371A Johnson 7-1/2" E5-372 Johnson 6" E5-374
 International E5-349	 Iron Fireman E5-357R	 Johnson E5-373
 Iron Fireman E5-356	 Iron Fireman E5-357S	 Johnson E5-373A
 Iron Fireman E5-357	 Iron Fireman E5-357U	 Johnson E5-375
 Iron Fireman E5-357A	 Iron Fireman E5-357W	 Johnson E5-375A

Westwood electrodes & insulators

HIGH DIELECTRIC STRENGTH • PRECISION DIMENSIONS

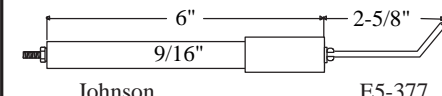
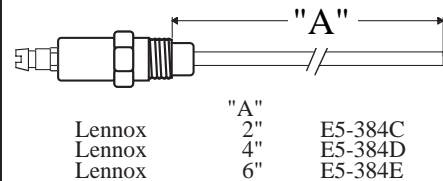
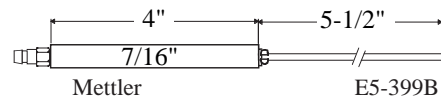
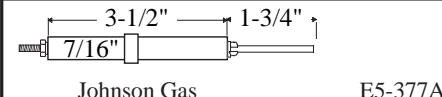
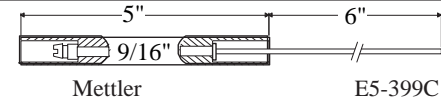
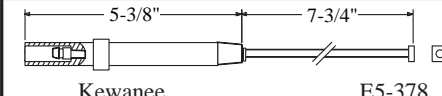
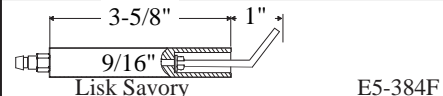
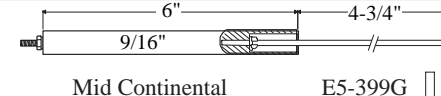
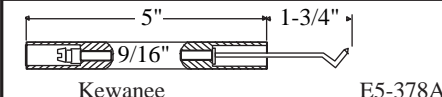
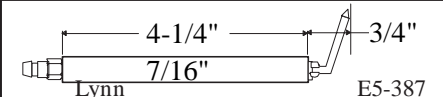
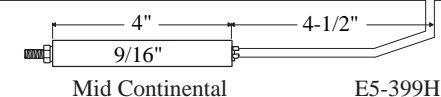
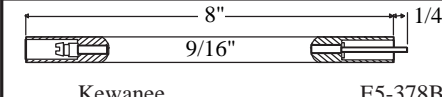
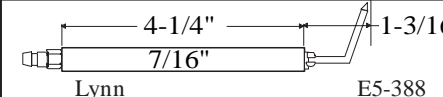
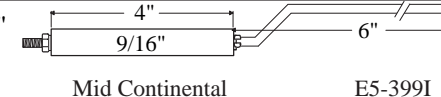
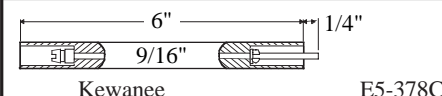
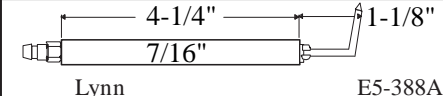
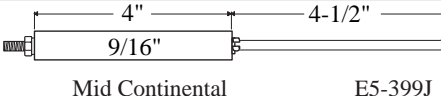
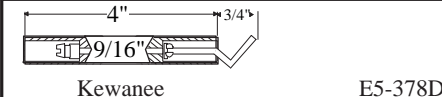
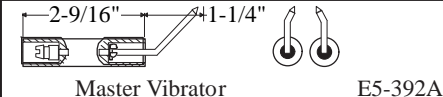
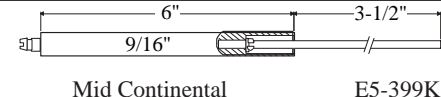
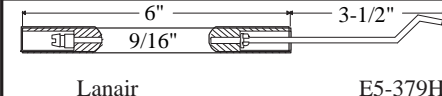
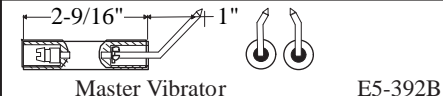
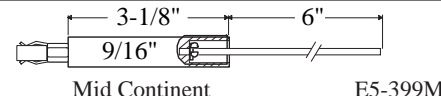
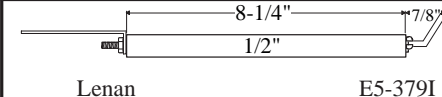
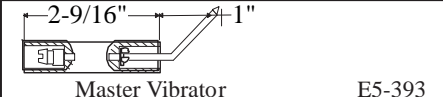
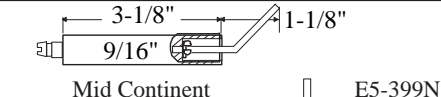
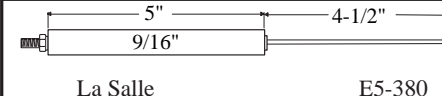
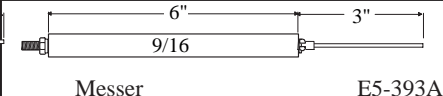
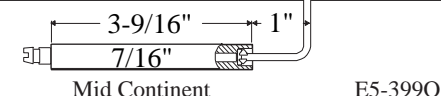
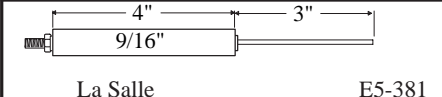
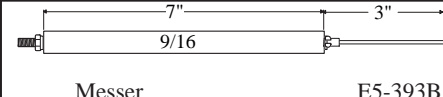
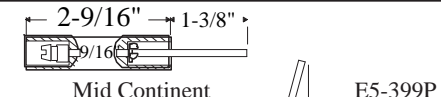
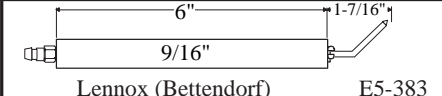
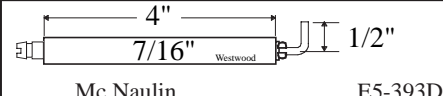
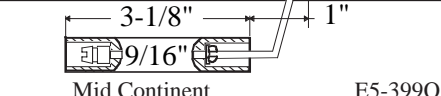
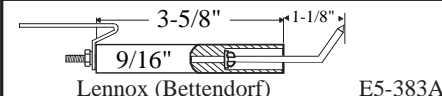
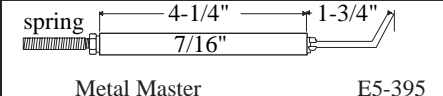
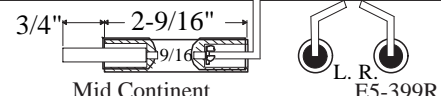
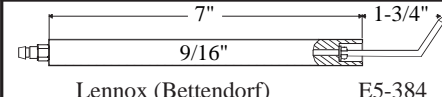
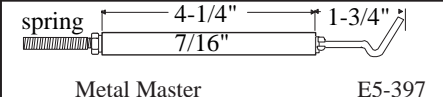
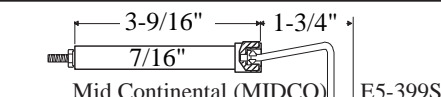
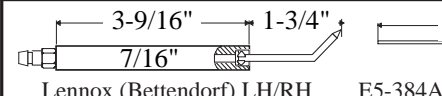
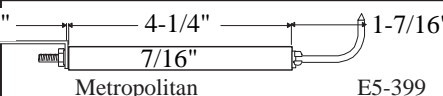
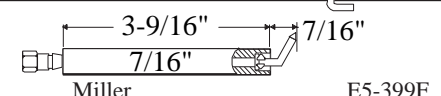
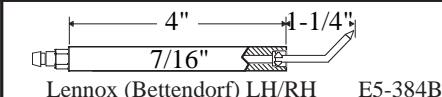
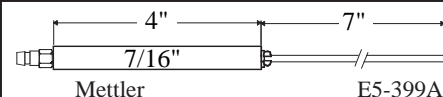
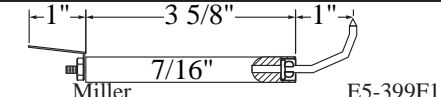
 <p>Johnson E5-377</p>	 <p>Lennox E5-384C Lennox E5-384D Lennox E5-384E</p>	 <p>Mettler E5-399B</p>
 <p>Johnson Gas E5-377A</p>	<p>"A" 2" E5-384C 4" E5-384D 6" E5-384E</p>	 <p>Mettler E5-399C</p>
 <p>Kewanee E5-378</p>	 <p>Lisk Savory E5-384F</p>	 <p>Mid Continental E5-399G</p>
 <p>Kewanee E5-378A</p>	 <p>Lynn E5-387</p>	 <p>Mid Continental E5-399H</p>
 <p>Kewanee E5-378B</p>	 <p>Lynn E5-388</p>	 <p>Mid Continental E5-399I</p>
 <p>Kewanee E5-378C</p>	 <p>Lynn E5-388A</p>	 <p>Mid Continental E5-399J</p>
 <p>Kewanee E5-378D</p>	 <p>Master Vibrator E5-392A</p>	 <p>Mid Continental E5-399K</p>
 <p>Lanair E5-379H</p>	 <p>Master Vibrator E5-392B</p>	 <p>Mid Continent E5-399M</p>
 <p>Lenan E5-379I</p>	 <p>Master Vibrator E5-393</p>	 <p>Mid Continent E5-399N</p>
 <p>La Salle E5-380</p>	 <p>Messer E5-393A</p>	 <p>Mid Continent E5-399O</p>
 <p>La Salle E5-381</p>	 <p>Messer E5-393B</p>	 <p>Mid Continent E5-399P</p>
 <p>Lennox (Bettendorf) E5-383</p>	 <p>Mc Naulin E5-393D</p>	 <p>Mid Continent E5-399Q</p>
 <p>Lennox (Bettendorf) E5-383A</p>	 <p>Metal Master E5-395</p>	 <p>Mid Continent E5-399R</p>
 <p>Lennox (Bettendorf) E5-384</p>	 <p>Metal Master E5-397</p>	 <p>Mid Continental (MIDCO) E5-399S</p>
 <p>Lennox (Bettendorf) LH/RH E5-384A</p>	 <p>Metropolitan E5-399</p>	 <p>Miller E5-399F</p>
 <p>Lennox (Bettendorf) LH/RH E5-384B</p>	 <p>Mettler E5-399A</p>	 <p>Miller E5-399F1</p>

Westwood electrodes & insulators

HIGH DIELECTRIC STRENGTH • PRECISION DIMENSIONS

 Miller E5-400A	 M&H (with Bracket) E5-409C-2	 Nu-Way E5-418F
 MSO Combustion E5-390	 M&H E5-409E	 Nu-Way E5-419
 MSO Combustion E5-391	 M&H E5-409F	 Nu-Way E5-420
 Monarch E5-400	 M&H E5-409G	 Nu-Way E5-420A
 Mueller E5-401	 M&H E5-409H	 Nu-Way E5-420A1
 Morrison E5-404	 M&H E5-409J	 Nu-Way E5-420B
 Mt Hawley E5-405	 M&H E5-409K	 Nu-Way E5-420C
 Mt Hawley RH/LH E5-406A	 National Airoil E5-411	 Nu-Way E5-421
 M&H E5-407	 National Airoil E5-412	 Nu-Way E5-425
 M&H E5-407A	 National Airoil E5-415	 Nu-Way E5-428
 M&H E5-408	 National Radiator E5-416	 Nu-Way E5-429
 M&H E5-409	 Northeast E5-417	 Nu-Way E5-429H
 M&H E5-409A	 Nu-Way E5-418	 Nu-Way E5-429A
 M&H E5-409B	 Nu-Way E5-418A	 Nu-Way E5-429B
 M&H E5-409C	 Nu-Way E5-418B	 Nu-Way E5-429C
 M&H E5-409D	 Nu-Way E5-430	 Nu-Way E5-430A

Please order by No.

Westwood electrodes & insulators

HIGH DIELECTRIC STRENGTH • PRECISION DIMENSIONS

<p>Oil Equipment E5-432</p>	<p>Petro 1-1/2" E5-468B Petro 2" E5-468C Petro 18" E5-468D</p>	<p>Power Flame E5-477I</p>
<p>Orr & Sembower E5-443</p>	<p>Power Flame E5-475-1</p>	<p>Power Flame E5-477J</p>
<p>Orr & Sembower E5-448</p>	<p>Power Flame E5-475</p>	<p>Power Flame E5-477K</p>
<p>Orr & Sembower E5-449</p>	<p>Power Flame E5-475A</p>	<p>Power Flame E5-478</p>
<p>Orr & Sembower E5-451</p>	<p>Power Flame (Kanthal tip) E5-475B</p>	<p>Power Flame E5-478A</p>
<p>Orr & Sembower E5-452</p>	<p>Power Flame E5-477</p>	<p>Power Flame E5-478B</p>
<p>Orr & Sembower E5-453</p>	<p>Power Flame 5.81" .50" E5-477A Power Flame 6.44" .38" E5-477B Power Flame 6.88" .47" E5-477C</p>	<p>Power Flame E5-478C</p>
<p>Peabody E5-457</p>	<p>Power Flame 5.81" 6.30" E5-477A-1 Power Flame 6.44" 6.69" E5-477B-1 Power Flame 6.88" 8.66" E5-477C-1</p>	<p>Power Flame E5-478D</p>
<p>Peabody E5-458</p>	<p>Power Flame E5-477E</p>	<p>Power Flame E5-478E</p>
<p>Penn Boiler E5-461</p>	<p>Power Flame E5-477F</p>	<p>Power Flame E5-479</p>
<p>Petro E5-465</p>	<p>Power Flame E5-477D</p>	<p>Power Flame E5-479A</p>
<p>Petro E5-465B</p>	<p>Power Flame E5-477E</p>	<p>Power Flame E5-479B</p>
<p>Petro E5-466</p>	<p>Power Flame E5-477F</p>	<p>Power Flame E5-479C</p>
<p>Petro 1-1/2" E5-467 Petro 2" E5-467A Petro 18" E5-467B Petro 6" E5-467G</p>	<p>Power Flame (Stainless tip) E5-477G</p>	<p>Power Flame E5-479D</p>
<p>Petro E5-468A</p>	<p>Power Flame E5-477H</p>	<p>Power Flame E5-479E</p>
<p>Petro E5-468A</p>	<p>Power Flame E5-479E1</p>	<p>Power Flame E5-479E1</p>

Westwood electrodes & insulators

HIGH DIELECTRIC STRENGTH • PRECISION DIMENSIONS

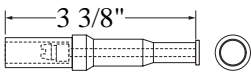
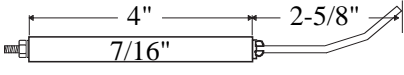
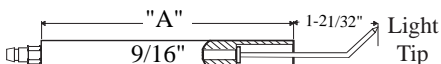
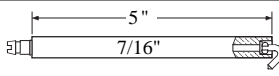
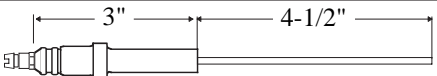
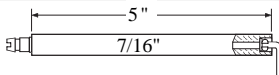
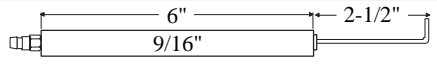
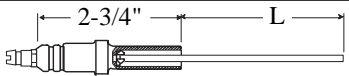
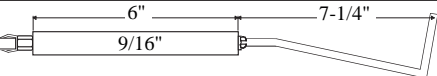
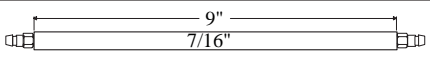
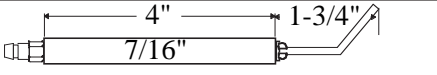
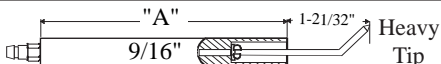
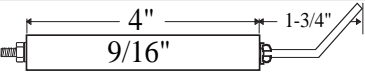
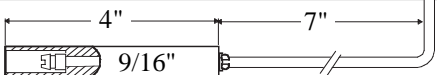
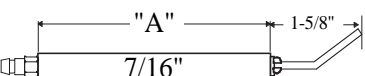
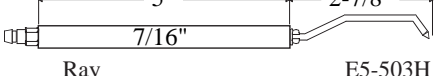
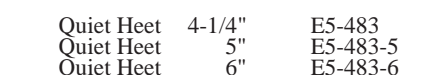
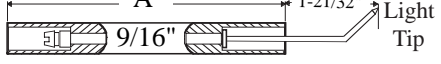
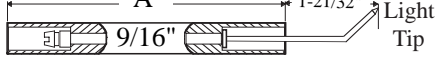
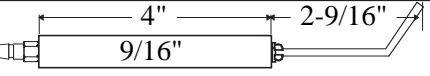
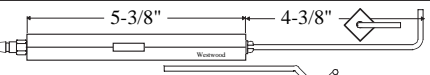
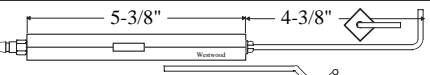
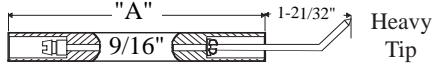
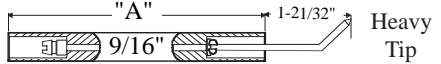
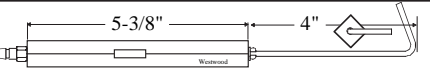
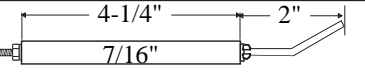
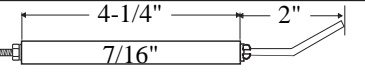
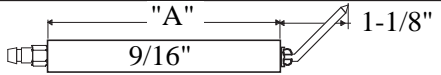
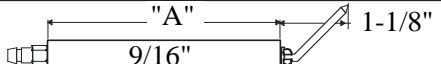
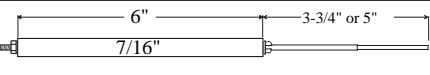
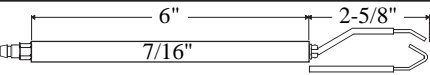
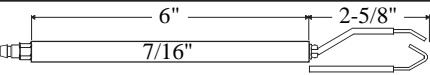
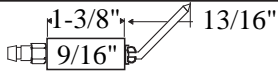
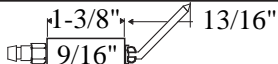
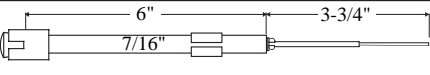
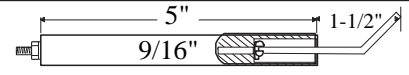
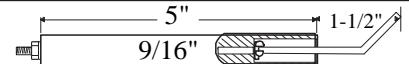
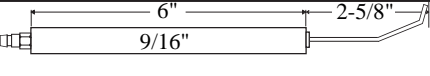
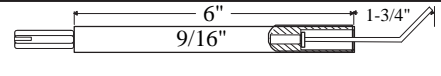
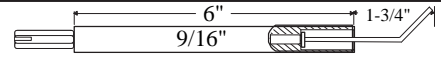
 <p>Preferred Utilities E5-471A</p>	 <p>Ray E5-502</p>	 <p>Light Tip</p>																																	
 <p>PVI E5-473F</p>	 <p>Ray E5-503A</p>	<table border="0"> <tr><td>Shellhead</td><td>4"</td><td>E5-513-4</td></tr> <tr><td>Shellhead</td><td>5"</td><td>E5-513-5</td></tr> <tr><td>Shellhead</td><td>6"</td><td>E5-513-6</td></tr> <tr><td>Shellhead</td><td>7"</td><td>E5-513-7</td></tr> <tr><td>Shellhead</td><td>8"</td><td>E5-513-8</td></tr> <tr><td>Shellhead</td><td>9"</td><td>E5-513-9</td></tr> <tr><td>Shellhead</td><td>10"</td><td>E5-513-10</td></tr> <tr><td>Shellhead</td><td>11"</td><td>E5-513-11</td></tr> <tr><td>Shellhead</td><td>12"</td><td>E5-513-12</td></tr> <tr><td>Shellhead</td><td>13"</td><td>E5-513-13</td></tr> <tr><td>Shellhead</td><td>14"</td><td>E5-513-14</td></tr> </table>	Shellhead	4"	E5-513-4	Shellhead	5"	E5-513-5	Shellhead	6"	E5-513-6	Shellhead	7"	E5-513-7	Shellhead	8"	E5-513-8	Shellhead	9"	E5-513-9	Shellhead	10"	E5-513-10	Shellhead	11"	E5-513-11	Shellhead	12"	E5-513-12	Shellhead	13"	E5-513-13	Shellhead	14"	E5-513-14
Shellhead	4"	E5-513-4																																	
Shellhead	5"	E5-513-5																																	
Shellhead	6"	E5-513-6																																	
Shellhead	7"	E5-513-7																																	
Shellhead	8"	E5-513-8																																	
Shellhead	9"	E5-513-9																																	
Shellhead	10"	E5-513-10																																	
Shellhead	11"	E5-513-11																																	
Shellhead	12"	E5-513-12																																	
Shellhead	13"	E5-513-13																																	
Shellhead	14"	E5-513-14																																	
 <p>PVI E5-473G</p>	 <p>Ray E5-503D</p>																																		
 <p>Pyronics E5-474C-1 6" E5-474C-2 12"</p>	 <p>Ray E5-503E</p>																																		
 <p>Pyronics E5-474E</p>	 <p>Ray E5-503F</p>	 <p>Heavy Tip</p>																																	
 <p>Quiet Automatic E5-480</p>	 <p>Ray E5-503G</p>	<table border="0"> <tr><td>Shellhead</td><td>4"</td><td>E5-514-4</td></tr> <tr><td>Shellhead</td><td>5"</td><td>E5-514-5</td></tr> <tr><td>Shellhead</td><td>6"</td><td>E5-514-6</td></tr> <tr><td>Shellhead</td><td>7"</td><td>E5-514-7</td></tr> <tr><td>Shellhead</td><td>8"</td><td>E5-514-8</td></tr> <tr><td>Shellhead</td><td>9"</td><td>E5-514-9</td></tr> <tr><td>Shellhead</td><td>10"</td><td>E5-514-10</td></tr> <tr><td>Shellhead</td><td>11"</td><td>E5-514-11</td></tr> <tr><td>Shellhead</td><td>12"</td><td>E5-514-12</td></tr> <tr><td>Shellhead</td><td>13"</td><td>E5-514-13</td></tr> <tr><td>Shellhead</td><td>14"</td><td>E5-514-14</td></tr> </table>	Shellhead	4"	E5-514-4	Shellhead	5"	E5-514-5	Shellhead	6"	E5-514-6	Shellhead	7"	E5-514-7	Shellhead	8"	E5-514-8	Shellhead	9"	E5-514-9	Shellhead	10"	E5-514-10	Shellhead	11"	E5-514-11	Shellhead	12"	E5-514-12	Shellhead	13"	E5-514-13	Shellhead	14"	E5-514-14
Shellhead	4"	E5-514-4																																	
Shellhead	5"	E5-514-5																																	
Shellhead	6"	E5-514-6																																	
Shellhead	7"	E5-514-7																																	
Shellhead	8"	E5-514-8																																	
Shellhead	9"	E5-514-9																																	
Shellhead	10"	E5-514-10																																	
Shellhead	11"	E5-514-11																																	
Shellhead	12"	E5-514-12																																	
Shellhead	13"	E5-514-13																																	
Shellhead	14"	E5-514-14																																	
 <p>Quiet Heet 4-1/4" E5-483 Quiet Heet 5" E5-483-5 Quiet Heet 6" E5-483-6</p>	 <p>Ray E5-503H</p>																																		
 <p>Radiant E5-490</p>	 <p>Ray E5-503I</p>	 <p>Light Tip</p>																																	
 <p>Rail E5-490</p>	 <p>Ray E5-503J</p>	<table border="0"> <tr><td>Shellhead</td><td>5"</td><td>E5-515-5</td></tr> <tr><td>Shellhead</td><td>6"</td><td>E5-515-6</td></tr> <tr><td>Shellhead</td><td>7"</td><td>E5-515-7</td></tr> <tr><td>Shellhead</td><td>8"</td><td>E5-515-8</td></tr> </table>	Shellhead	5"	E5-515-5	Shellhead	6"	E5-515-6	Shellhead	7"	E5-515-7	Shellhead	8"	E5-515-8																					
Shellhead	5"	E5-515-5																																	
Shellhead	6"	E5-515-6																																	
Shellhead	7"	E5-515-7																																	
Shellhead	8"	E5-515-8																																	
 <p>Rails E5-489B</p>	 <p>Ray E5-503M</p>	 <p>Heavy Tip</p>																																	
 <p>Rails E5-489C</p>	 <p>Ray E5-503P</p>	<table border="0"> <tr><td>Shellhead</td><td>5"</td><td>E5-516-5</td></tr> <tr><td>Shellhead</td><td>6"</td><td>E5-516-6</td></tr> </table>	Shellhead	5"	E5-516-5	Shellhead	6"	E5-516-6																											
Shellhead	5"	E5-516-5																																	
Shellhead	6"	E5-516-6																																	
 <p>Rasol E5-494</p>	 <p>Ray E5-503Q</p>	 <p>Light Tip</p>																																	
 <p>Ray E5-499 3-3/4" E5-499C 5"</p>	 <p>Robert Gordon E5-506B</p>	<table border="0"> <tr><td>Silent Glow</td><td>3"</td><td>E5-523</td></tr> <tr><td>Silent Glow</td><td>4"</td><td>E5-524</td></tr> <tr><td>Silent Glow</td><td>5"</td><td>E5-525</td></tr> <tr><td>Silent Glow</td><td>6"</td><td>E5-526</td></tr> <tr><td>Silent Glow</td><td>11-3/4"</td><td>E5-527</td></tr> </table>	Silent Glow	3"	E5-523	Silent Glow	4"	E5-524	Silent Glow	5"	E5-525	Silent Glow	6"	E5-526	Silent Glow	11-3/4"	E5-527																		
Silent Glow	3"	E5-523																																	
Silent Glow	4"	E5-524																																	
Silent Glow	5"	E5-525																																	
Silent Glow	6"	E5-526																																	
Silent Glow	11-3/4"	E5-527																																	
 <p>Ray E5-499D</p>	 <p>Robert Gordon E5-506C</p>	 <p>Silent Glow E5-523A</p>																																	
 <p>Ray E5-500</p>	 <p>Sandberg E5-510</p>	 <p>Stewart Warner E5-545</p>																																	
 <p>Ray E5-501</p>	 <p>Scully Fastlite E5-512A</p>	 <p>Stewart Warner E5-545A</p>																																	

Westwood electrodes & insulators

HIGH DIELECTRIC STRENGTH • PRECISION DIMENSIONS

 Sun Ray E5-550	 Sun Ray E5-559N	 "A" 9/16" 2"
 Sun Ray E5-553	 3" "A" "B"	Todd 8-3/4" E5-578 Todd 10-1/4" E5-578A Todd 12" E5-579 Todd 14" E5-580 Todd 17" E5-581 Todd 19" E5-582 Todd 21" E5-582A Todd 23" E5-582B Todd 24" E5-582C
 Sun Ray E5-556	Superior 3-1/2" 4-1/2" E5-546 Superior 4-1/2" 6" E5-546A Superior 10-1/4" 5" E5-546B Superior 3" 3" E5-546C Superior 3" 2-1/4" E5-546D Superior 8-1/2" 3" E5-546E Superior 3-1/2" 8" E5-546F Superior 12-1/2" 4" E5-546G	 7-3/4" 9/16" 3" Tornado Todd E5-588B
 Sun Ray E5-557	 6" 9/16" 2-3/4" Superior E5-547	 5" 9/16" 3" Torrid Heat E5-584
 Sun Ray E5-558	 "A" 9/16" "B"	 5" 1/2" 2" Volcano E5-590
 Sun Ray E5-559	Superior 14-3/4" 5" E5-547A Superior 18-1/2" 3-3/4" E5-547B Superior 16-1/2" 3-1/4" E5-547C Superior 13-1/2" 3" E5-547E	 3" 4" 1-7/16" 1/2" Wayne E5-601A
 Sun Ray E5-559B	 4-1/2" Superior Bulkhead E5-547D	Waltham 3-1/2" E5-600-3 Waltham 4" E5-600-4 Waltham 5" E5-600-5 Waltham 6" E5-600-6
 Sun Ray E5-559C	 4-1/2" 2" 3-1/4" Superior E5-547F	 1-3/4" 4" 1-7/16" 1/2" Wayne E5-601B
 Sun Ray E5-559D	 4-1/4" 7/16" 1-3/4" Terry Burner E5-562	 6" 9/16" 2-3/8" Wayne E5-603
 Sun Ray E5-559E	 4" 1/2" 1-3/8" Thatcher E5-560	 4" 1/2" 1-7/8" Wayne E5-604
 Sun Ray E5-559F	 9/16" R Timken "F" Adjustable E5-566	 5" 1/2" 5-1/2" 1-7/16" Wayne E5-604A
 Sun Ray E5-559G	 3/4" R Timken "C" Adjustable E5-567	 5-1/2" 9/16" 1-3/4" 1" 2" Wayne E5-604B
 Sun Ray E5-559H	 11-7/16" 7/16" 4" Todd E5-577A	 5" 9/16" 7" 1" 2" Wayne E5-604C
 Sun Ray E5-559I	 "A" 9/16" 5" Todd 13" E5-579A Todd 16" E5-579B Todd 19" E5-579C Todd 21" E5-579D Todd 22" E5-579E	 5" 9/16" 2-1/4" 1" 2" Wayne E5-604D
 Sun Ray E5-559J		
 Sun Ray E5-559K		
 Sun Ray E5-559L		
 Sun Ray E5-559M		

Westwood electrodes & insulators

HIGH DIELECTRIC STRENGTH • PRECISION DIMENSIONS

 Wayne E5-605	 Waywolf E5-606A	 York E5-631C
 Wayne E5-605A	 Webster Engineering E5-599E	 York E5-632
 Wayne E5-605B	 Webster Engineering E5-599F	 York E5-632A
 Wayne E5-605C	 Webster Engineering E5-599G	 York E5-632B
 Wayne E5-605D	 Webster Engineering E5-599J	 York E5-632C
 Wayne E5-605E	 Webster Engineering E5-599K	 York E5-632D
 Wayne Blue Angel E5-605F	 Weil-McLain, electrode only E5-598 Weil-McLain electrode w/leads E5-598A Leads only (former WMK-150) E5-598B	 York E5-632E
 Wayne Blue Angel E5-605F1		 York E5-633
 Wayne Blue Angel (with pointed tip) E5-605F2		 York E5-634
 Wayne E5-605G		 York E5-634A
 Wayne E5-605H		 York (Levittown) E5-635
 Wayne E5-605I	 Williams E5-624	 York E5-636
 Wayne E5-605J	 John Wood E5-623	 York E5-637
 Wayne E5-605K	 York E5-630 York E5-631	 York E5-638
 Wayne E5-605L	 York E5-632	 York E5-639
 Wayne E5-605M	 York E5-630 York E5-631	 York E5-640
 Wayne E5-605N	 York E5-629 York E5-630A	 York E5-638
 Wayne E5-605P	 York E5-631B	 Zenith E5-640
 Wayne E5-606	 York E5-629 York E5-631B	 Zenith E5-641

Please order by No.

rev. 1-1-09

E14

Westwood

ELECTRODE KITS

FOR THE SERVICE PROFESSIONAL

**ELECTRODE & INSULATOR KITS****Serviceman's Deluxe Kit****OEM Electrodes - 2 ea.**

ABC: E5-146

Beckett: E5-151E, E5-151O

Carlin: E5-188B, E5-188N, E5-188K

Quiet Heat: E5-483

Wayne: E5-604, E5-605, E5-605B,
E5-605F, E5-606**Rajah™ Terminals - 10 ea.**

E9-CT, E9-SS, E9-R-2, E9-RAC, E9-SF,

E9-BS 6-32, E9-BS 10-32,

E9-HS 6-32 (5 ea.), E9-HS 10-32 (5 ea.),
6-32 nut, 10-32 nut**Standard Electrodes - 2 ea.**E5-1M4, E5-2M4, E5-2M5, E5-2M6,
E5-4M4, E5-3M4, E5-3M5, E5-3M6**Also includes**

5 feet of GTO-15 ignition cable

1 set (2) T100-230 electrode benders

1 - T100-220 electrode gauge

1 set (2) T100-70 jumpers

1 - NAS gauge™ nozzle gauge

1 - Coupler Popper™ tool

1 - Plastic carrying case

 No. E5-2001
Serviceman's Super KitsSame contents as the E5-2001 Deluxe Kit, less the NAS gauge™ and Coupler Popper™
in a plastic carrying case
 No. E5-1897
Same contents as the E5-2001 Deluxe Kit, less the NAS gauge™ and Coupler Popper™
in a cardboard box
 No. E5-1897-C
ELECTRODE & INSULATOR ROLL-UP KITS**Contains:****Electrodes - 2 ea.**

E5-3M4 (9/16"x4"), E5-3M5 (9/16"x5"),

E5-3M6 (9/16"x6"), E5-3F5 (9/16"x5"),

E5-483 (Quiet Heat)

Insulators - 2 ea.

E5-1M4-1/4 (7/16"x4-1/4"), E5-4M4 (1/2"x4"),

E5-2M4 (9/16"x4"), E5-2M5 (9/16"x5"),

E5-3M4 (9/16"x4")

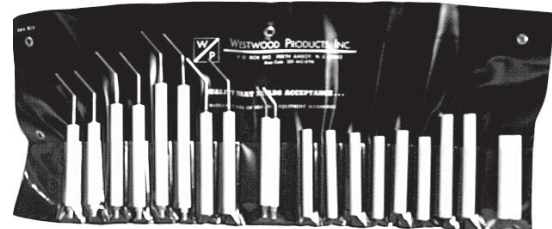
 No. E5-595
Contains:**Electrodes - 2 ea.**

E5-188N (Carlin), E5-151E (Beckett),

E5-605 (Wayne), E5-2M4 (9/16"x4"),

E5-2M5 (9/16"x5"), E5-2M6 (9/16"x6"),

E5-2F5 (female 5"), E5-2F6 (female 6")

Insulators - 2 ea.

E5-1M4-1/4 (7/16"x4-1/4"), E5-3M4 (9/16"x4"),

E5-2M4 (9/16"x4"), E5-2M5 (9/16"x5"),

E5-2M6 (9/16"x6"), E5-2F5 (female 5"),

E5-2F6 (female 6"), E5-4M4 (1/2"x4")

 No. E5-920

Westwood

ELECTRODE KITS

FOR THE SERVICE PROFESSIONAL

**ELECTRODE & INSULATOR ROLL-UP KITS (Continued)**

For Servicing
Beckett Burners

Contains these electrodes:

4 · E5-151E	2 · E5-151D
2 · E5-151E1	2 · E5-151R
2 · E5-151O	2 · E5-151G
2 · E5-151F	2 · E5-151J
2 · E5-151	



 No. E5-BK-400

For Servicing
Carlin Burners

Contains these electrodes:

4 · E5-188N	2 · E5-188P
4 · E5-188B	2 · E5-188Q
2 · E5-188K	2 · E5-188R3
2 · E5-188R-2	2 · E5-188N4
2 · E5-188H	



 No. E5-CK-300

For Servicing
Wayne Burners

Contains these electrodes:

4 · E5-605	2 · E5-605E
4 · E5-606	2 · E5-605C
2 · E5-605B	2 · E5-605D
2 · E5-605F	2 · E5-605F1
2 · E5-604	



 No. E5-WK-500

 Take a look . . .

PORCELAIN CUTTER No. T100-370 on page T17
&
RAJAH TERMINAL KITS on page E33

Please order by  No.

rev. 5-1-07

E16

Westwood
AUBURN IGNITION PRODUCTS
 IGNITORS • FLAME RODS • LIQUID LEVEL ELECTRODES



NOTE: Auburn ignition products part numbers are now "E5-" followed by the former number.

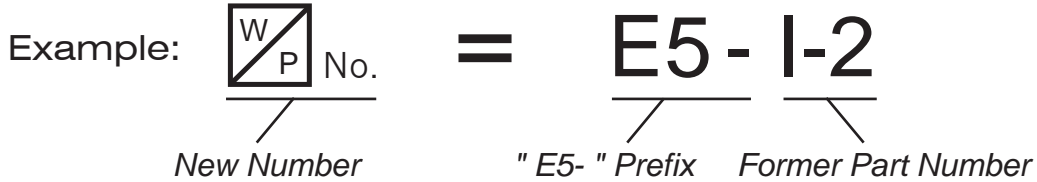

149T-1 (.090)

No.	Ref. No.
E5-149T-1-090	149T-1-090

I-2-EI-2

No.	Ref. No.
E5-I-2-EI-2	I-2-EI-2

F-68

No.	Ref. No.
E5-F-68	F-68

I-2 Series

No.	Ref. No.	"A" DIM.	"B" DIM.
E5-I-2	I-2	8.00	4.50
E5-I-2-1	I-2-1	15.50	12.00
E5-I-2-2	I-2-2	27.50	24.00

F-140

No.	Ref. No.
E5-F-140	

New!

* Dimensions marked with an asterisk are standard lengths - Other lengths available upon request

AUBURN ELECTRODES

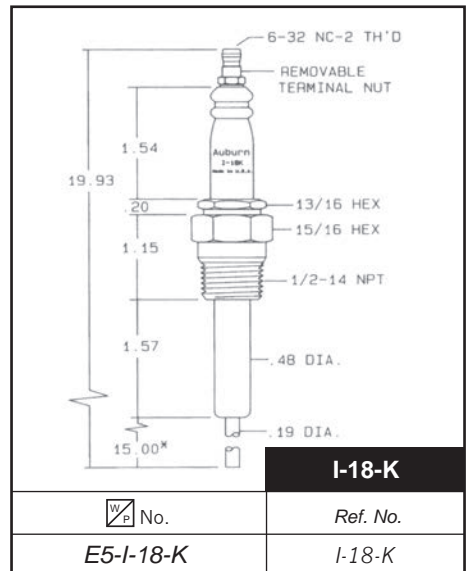
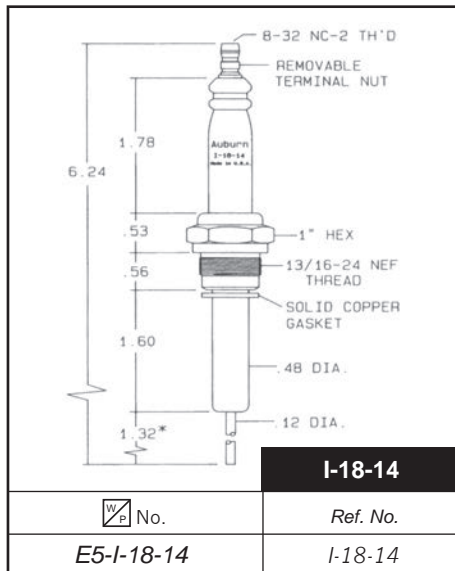
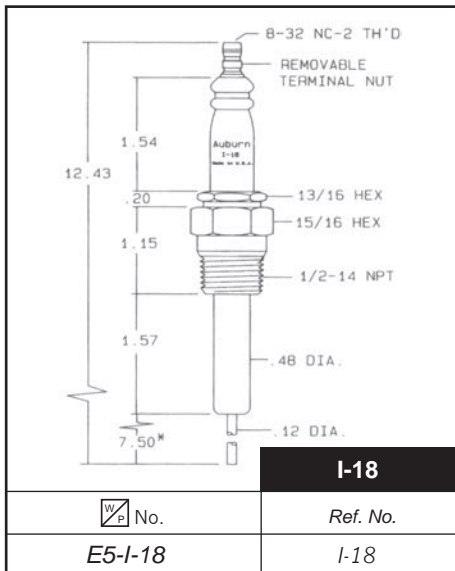
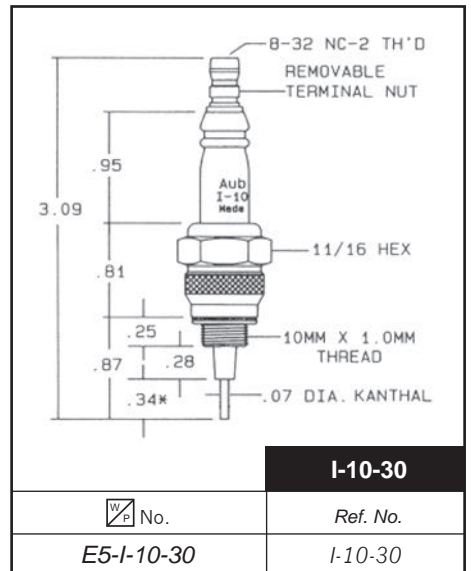
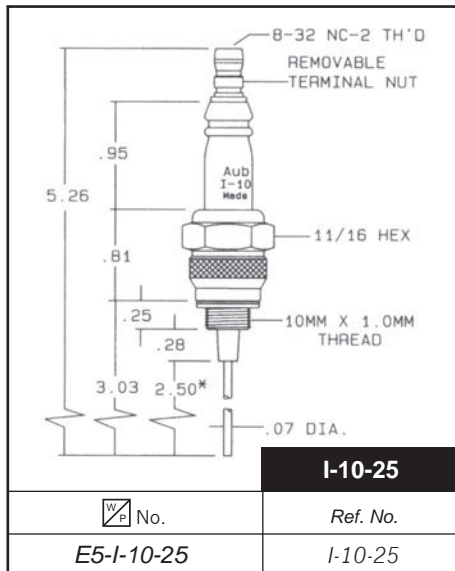
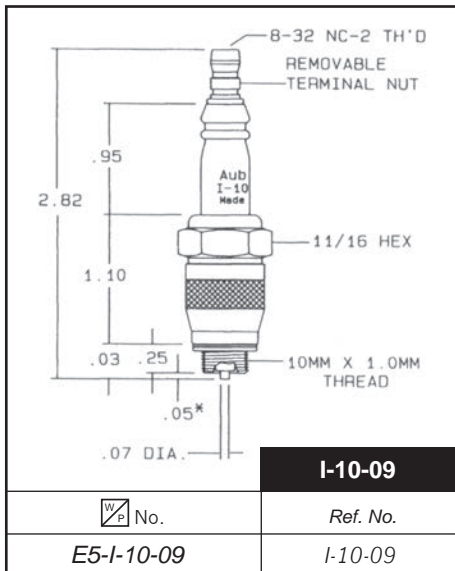
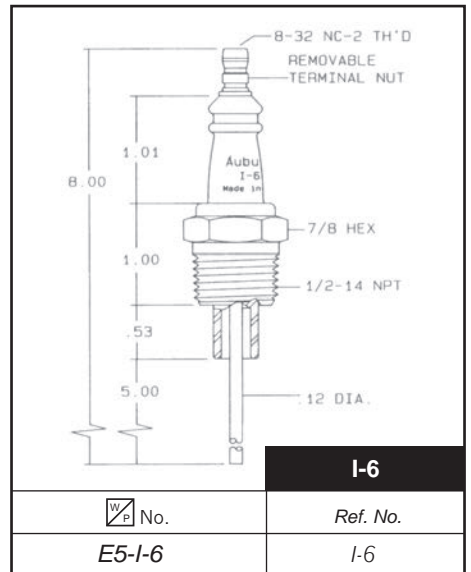
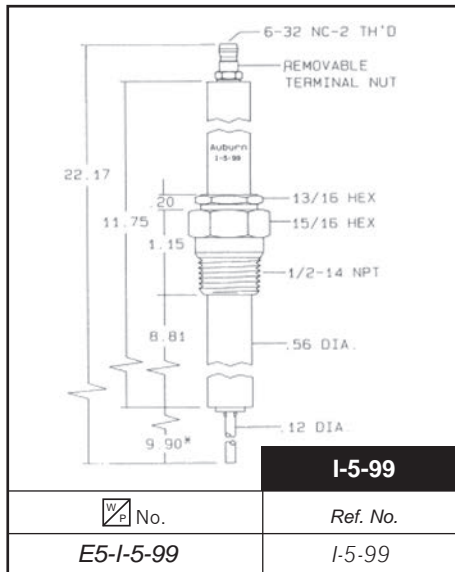
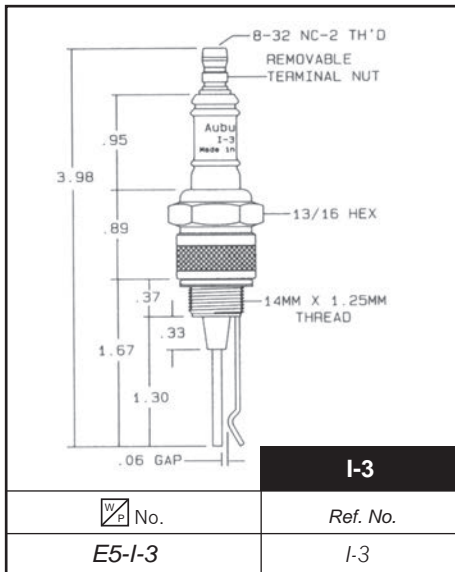

* Dimensions marked with an asterisk are standard lengths - Other lengths available upon request

Please order by No.

AUBURN ELECTRODES

I-25

No.	Ref. No.
E5-I-25	I-25

I-25-3

No.	Ref. No.
E5-I-25-3	I-25-3

I-25-4

No.	Ref. No.
E5-I-25-4	I-25-4

I-28

No.	Ref. No.
E5-I-28	I-28

I-31 Series

No.	Ref. No.	"A"	"B"	ELEC. MAT.
E5-I-31	I-31	3.68	1.37	NICKEL
E5-I-31-1	I-31-1	4.17	1.87	NICKEL
E5-I-31-2	I-31-2	4.81	2.50	NICKEL
E5-I-31-3	I-31-3	4.17	1.87	INCONEL

I-32

No.	Ref. No.
E5-I-32	I-32

I-33

No.	Ref. No.
E5-I-33	I-33

As a major distributor of Auburn Ignition Products, Westwood can special order any Auburn item not shown in this catalog and get it to you fast!

* Dimensions marked with an asterisk are standard lengths - Other lengths available upon request

AUBURN ELECTRODES

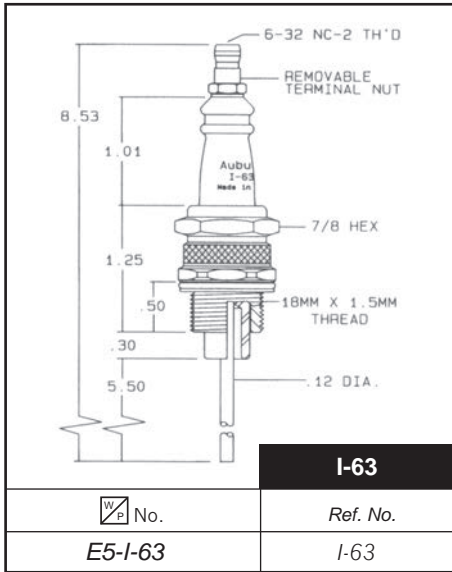

I-63

No.	Ref. No.
E5-I-63	I-63

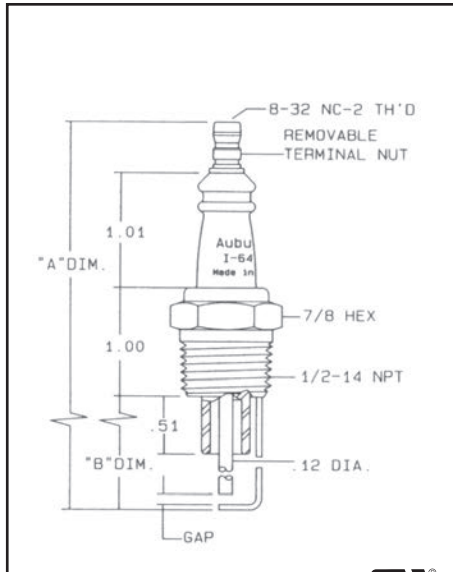

I-64 Series

No.	Ref. No.	"A"	"B"	GAP	ELEC. MAT.
E5-I-64-1	I-64-1	4.20	1.72	.090	NI
E5-I-64-3	I-64-3	6.24	3.75	.090	NI
E5-I-64-4 ¹	I-64-4	3.60	1.12	.100	NI
E5-I-64-7	I-64-7	4.70	2.21	.100	NI

¹UL Recognized Component

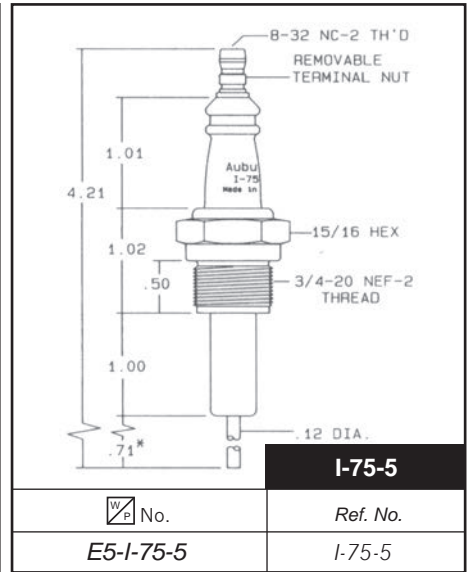

I-75-5

No.	Ref. No.
E5-I-75-5	I-75-5

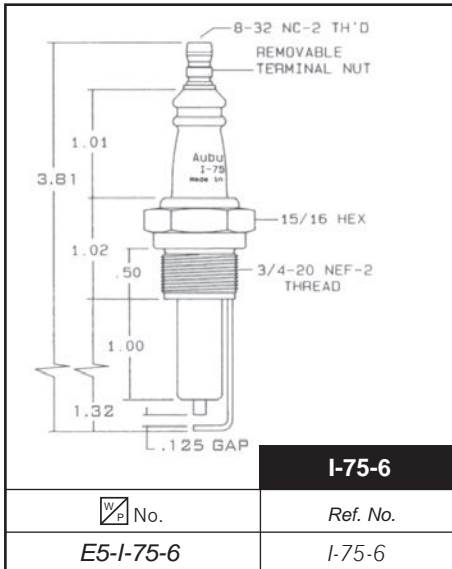

I-75-6

No.	Ref. No.
E5-I-75-6	I-75-6

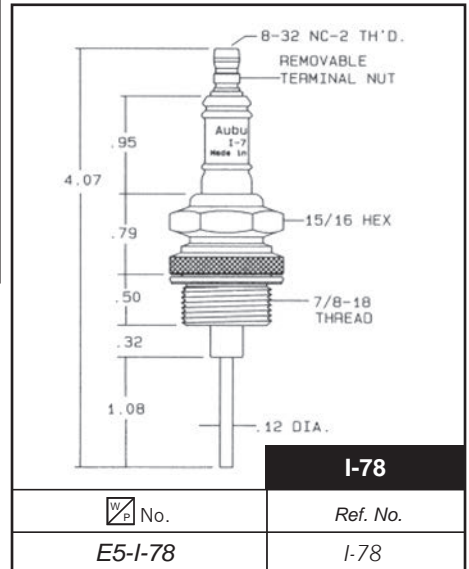

I-78

No.	Ref. No.
E5-I-78	I-78

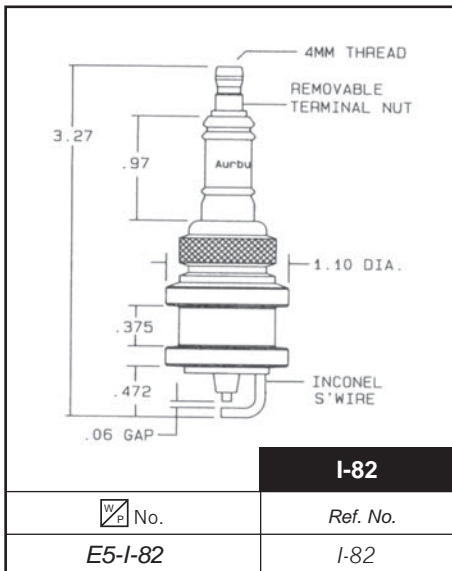

I-82

No.	Ref. No.
E5-I-82	I-82

As a major distributor of Auburn Ignition Products, Westwood can special order any Auburn item not shown in this catalog and get it to you fast!

* Dimensions marked with an asterisk are standard lengths - Other lengths available upon request

Please order by No.

AUBURN ELECTRODES

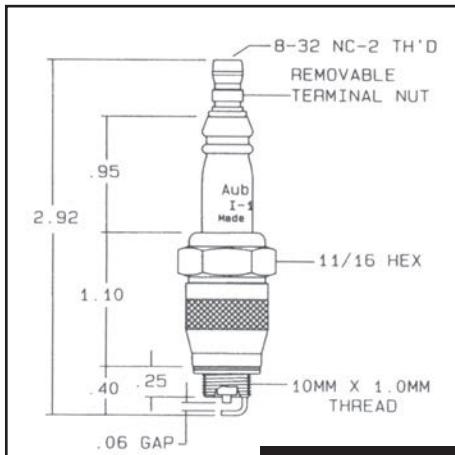

I-101

No.	Ref. No.
E5-I-101	I-101

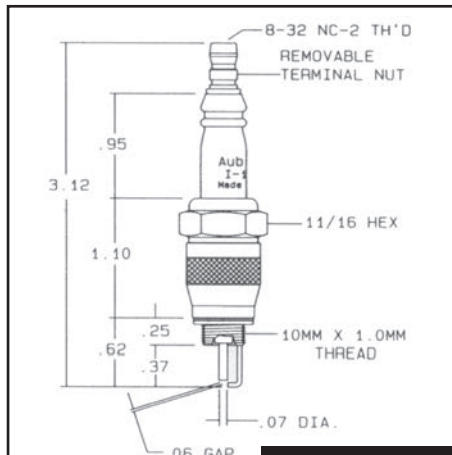

I-102

No.	Ref. No.
E5-I-102	I-102

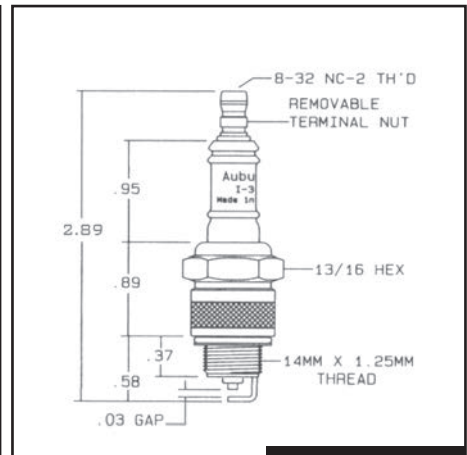

I-141

No.	Ref. No.
E5-I-141	I-141

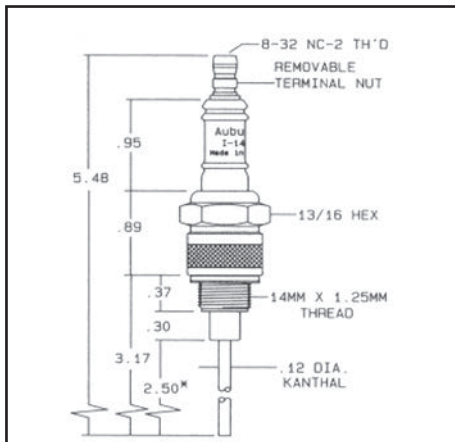

I-143

No.	Ref. No.
E5-I-143	I-143

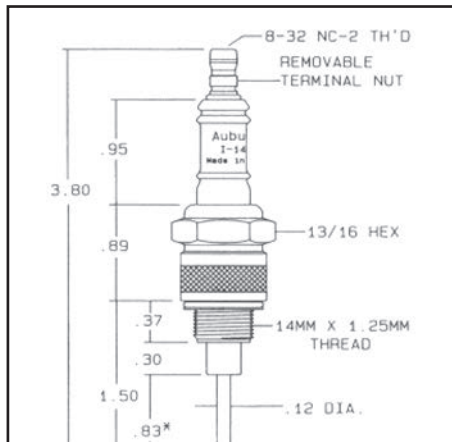

I-144

No.	Ref. No.
E5-I-144	I-144

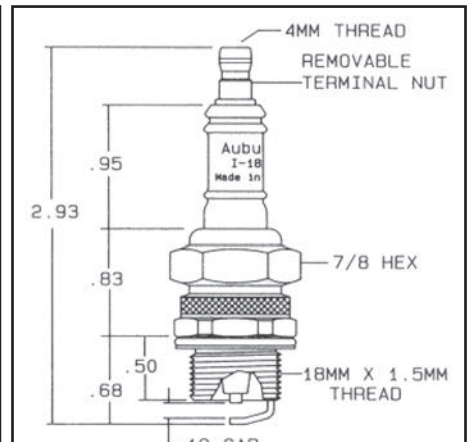

I-181

No.	Ref. No.
E5-I-181	I-181

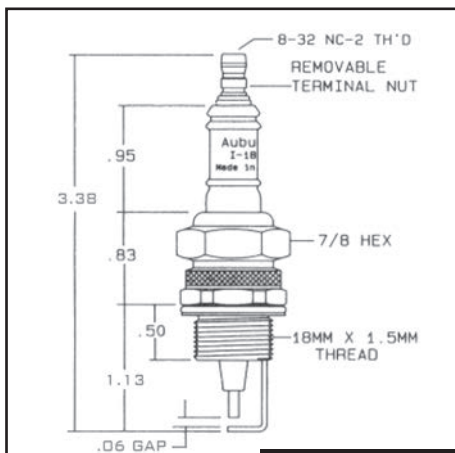

I-182

No.	Ref. No.
E5-I-182	I-182

As a major distributor of Auburn Ignition Products, Westwood can special order any Auburn item not shown in this catalog and get it to you fast!

* Dimensions marked with an asterisk are standard lengths - Other lengths available upon request

AUBURN ELECTRODES

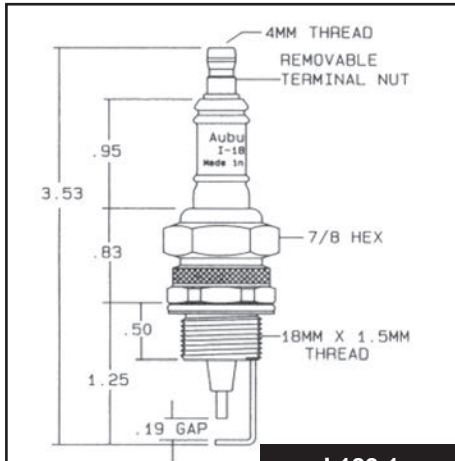

I-182-1

No.	Ref. No.
E5-I-182-1	I-182-1

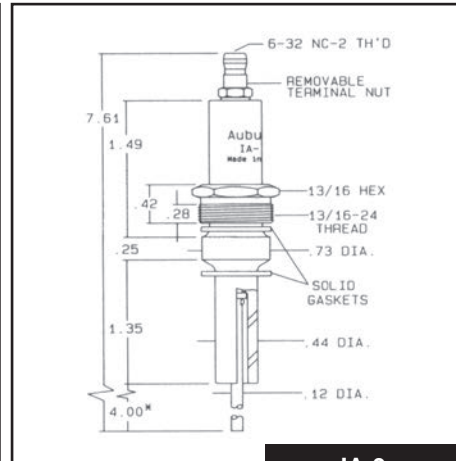

IA-9

No.	Ref. No.
E5-IA-9	IA-9

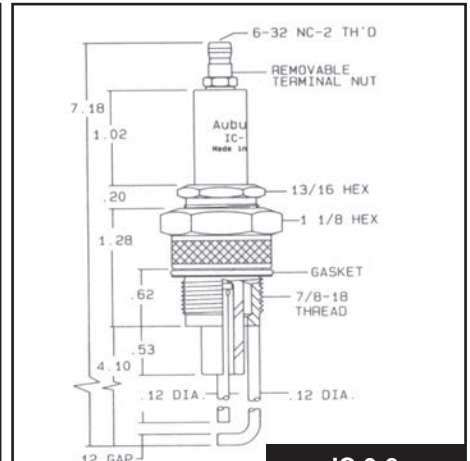

IC-9-2

No.	Ref. No.
E5-IC9-2	IC9-2

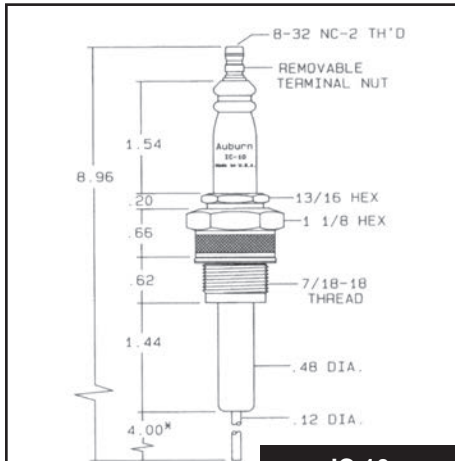

IC-10

No.	Ref. No.
E5-IC-10	IC-10

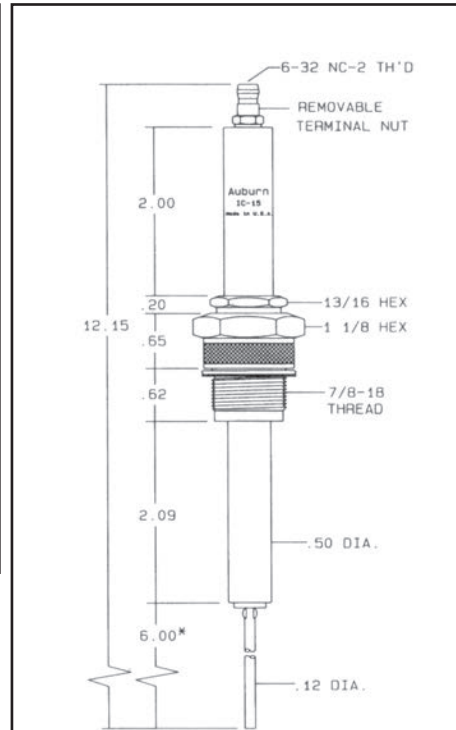

IC-15

No.	Ref. No.
E5-IC-15	IC-15

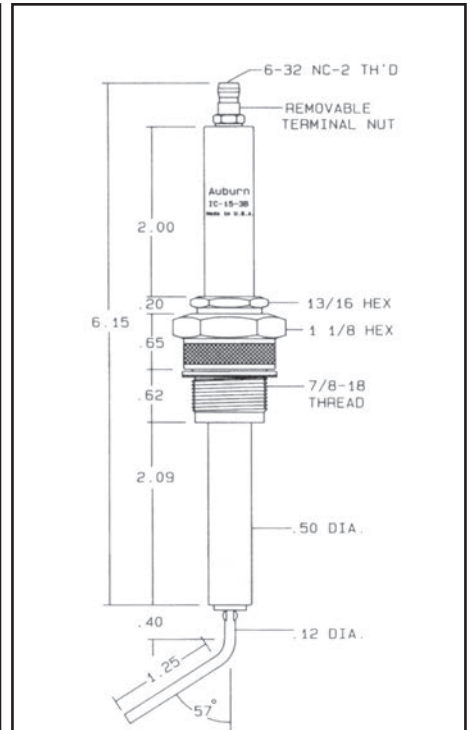

CHROMEL "D"
Center Wire

IC-15-3B

No.	Ref. No.
E5-IC-15-3B	IC-15-3B

As a major distributor of Auburn Ignition Products, Westwood can special order any Auburn item not shown in this catalog and get it to you fast!

* Dimensions marked with an asterisk are standard lengths - Other lengths available upon request

AUBURN ELECTRODES

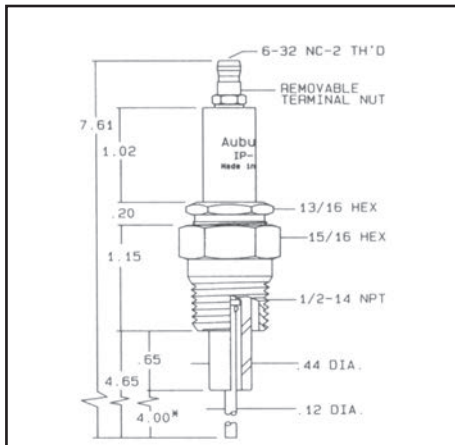

IP-9

No.	Ref. No.
E5-IP-9	IP-9

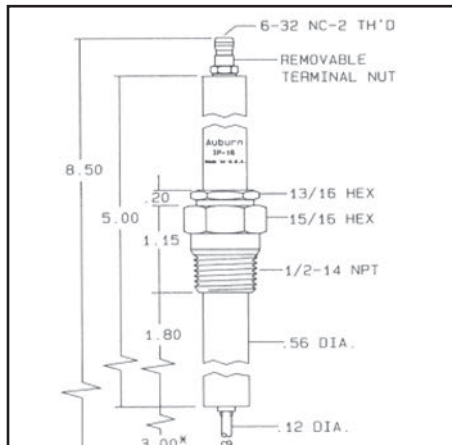

IP-16

No.	Ref. No.
E5-IP-16	IP-16

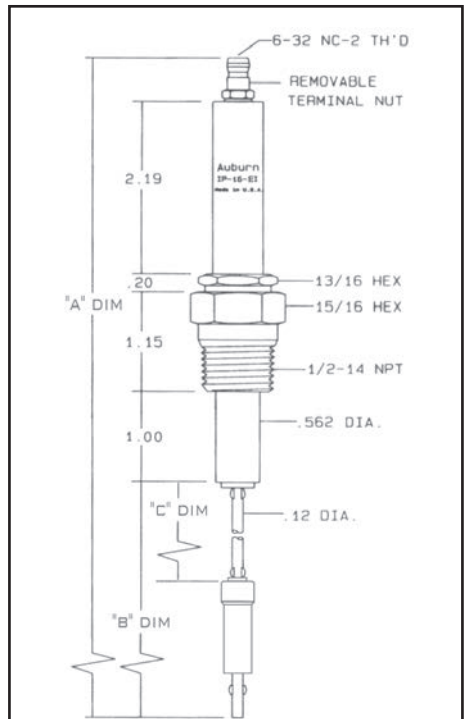

IP-16-EI Series

No.	Ref. No.	"A"	"B"	"C"
E5-IP-16-EI	IP-16-EI	18.75	13.25	11.25

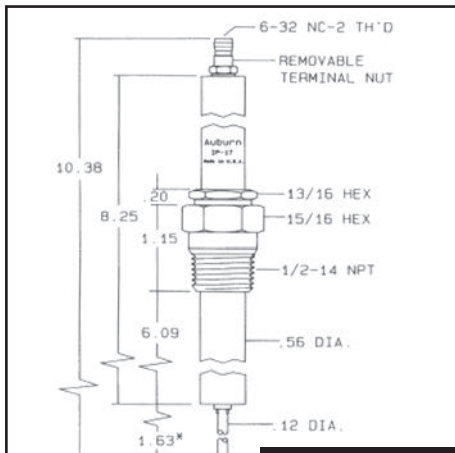

IP-17

No.	Ref. No.
E5-IP-17	IP-17

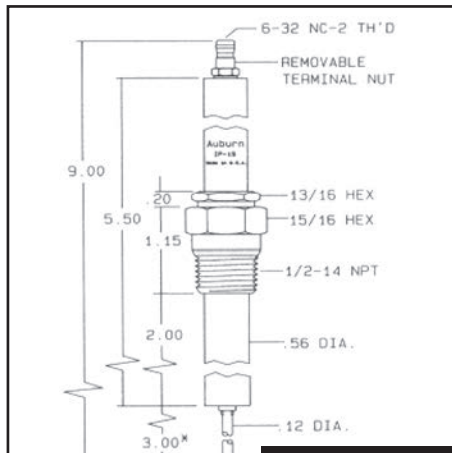

IP-19

No.	Ref. No.
E5-IP-19	IP-19

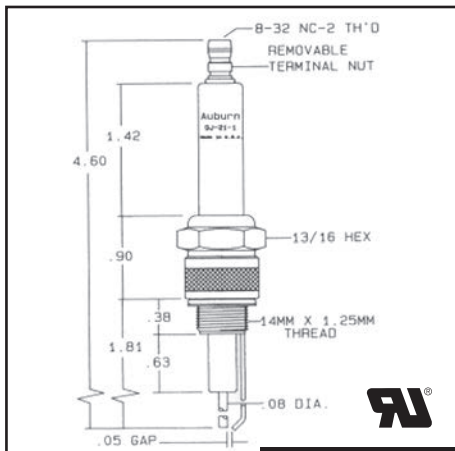

OJ-21-1

No.	Ref. No.
E5-OJ-21-1	OJ-21-1

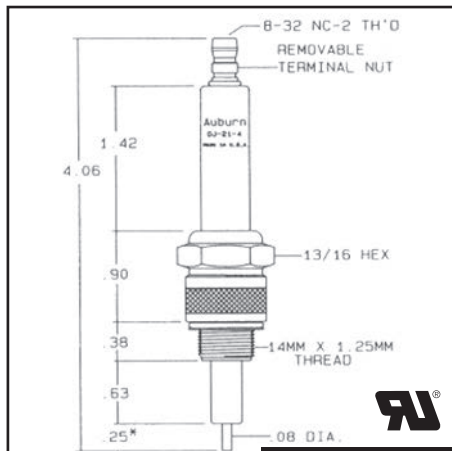

OJ-21-4

No.	Ref. No.
E5-OJ-21-4	OJ-21-4

As a major distributor of Auburn Ignition Products, Westwood can special order any Auburn item not shown in this catalog and get it to you fast!

* Dimensions marked with an asterisk are standard lengths - Other lengths available upon request

AUBURN ELECTRODES & FLAME RODS

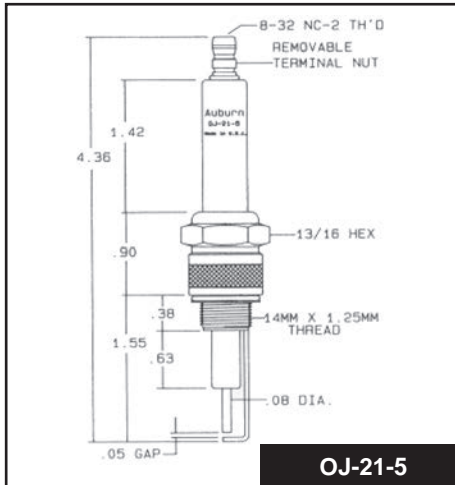

OJ-21-5

No.	Ref. No.
E5-OJ-21-5	OJ-21-5

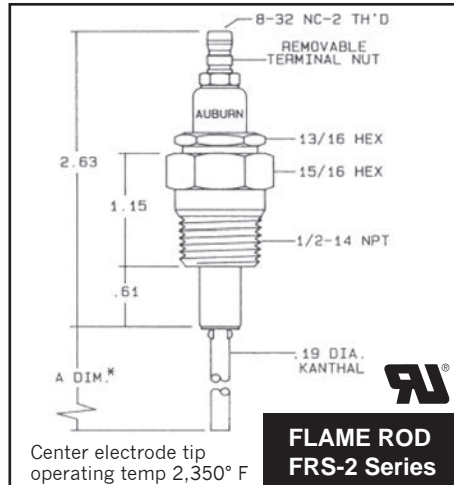

Center electrode tip operating temp 2,350° F

FLAME ROD FRS-2 Series

No.	Ref. No.	"A" DIM.
E5-FRS-2-6	FRS-2-6	6"
E5-FRS-2-12	FRS-2-12	12"
E5-FRS-2-18	FRS-2-18	18"
E5-FRS-2-24	FRS-2-24	24"

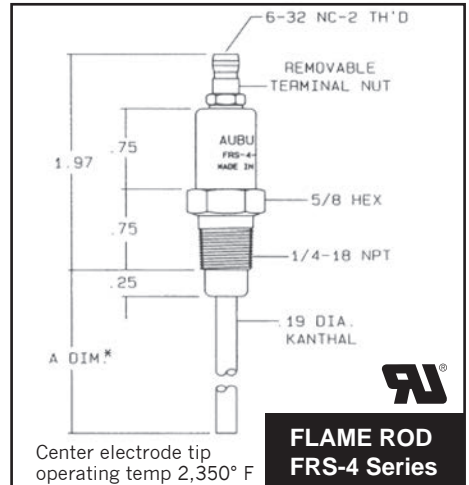

Center electrode tip operating temp 2,350° F

FLAME ROD FRS-4 Series

No.	Ref. No.	"A" DIM.
E5-FRS-4-4	FRS-4-4	4"
E5-FRS-4-6	FRS-4-6	6"
E5-FRS-4-12	FRS-4-12	12"
E5-FRS-4-24	FRS-4-24	24"

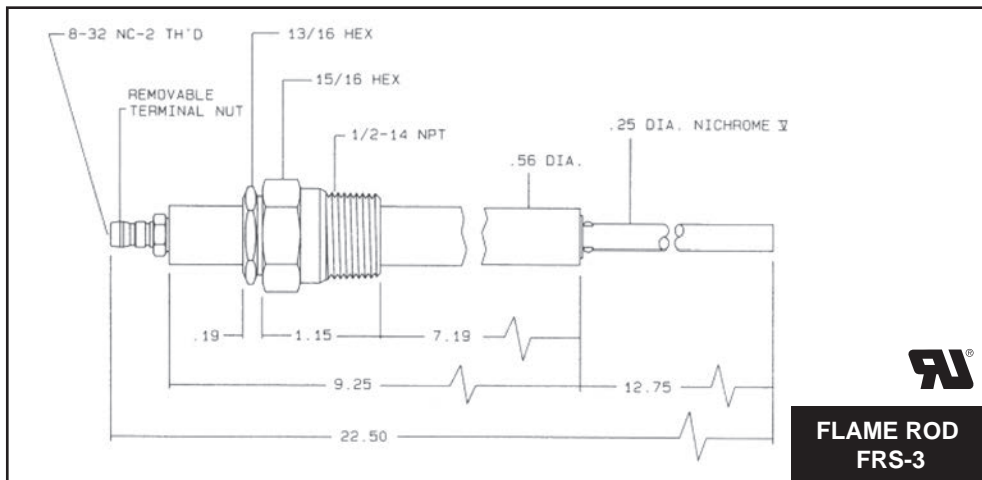

FLAME ROD FRS-3

No.	Ref. No.
E5-FRS-3	FRS-3

As a major distributor of Auburn Ignition Products, Westwood can special order any Auburn item not shown in this catalog and get it to you fast!

* Dimensions marked with an asterisk are standard lengths - Other lengths available upon request

AUBURN LIQUID LEVEL ELECTRODES

WCC Series:

Metal parts are 303 or 304 non-magnetic stainless steel. Incorporates an internal conductive glass seal (not recommended for use above 450 volts). Non-steam applications up to 2,500 PSI at 120° F or 0 PSI at 700° F. Steam applications up to 250 PSI at 406° F

WCC-KH Series:

Metal parts are 303 or 304 non-magnetic stainless steel. Incorporates a special insulator tip seal and Kovar center wire-glass seal. Non-steam applications up to 2,500 PSI at 120° F or 0 PSI at 450° F. Steam applications up to 450 PSI at 459° F

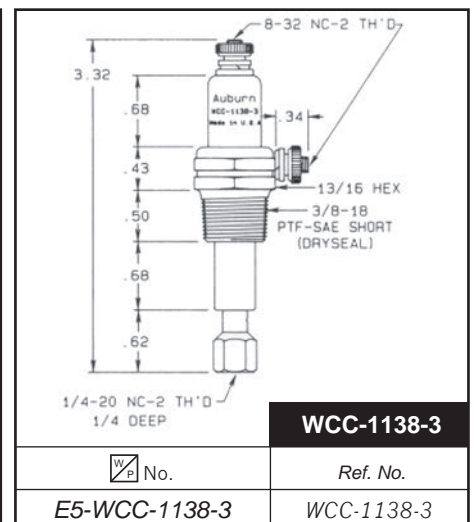
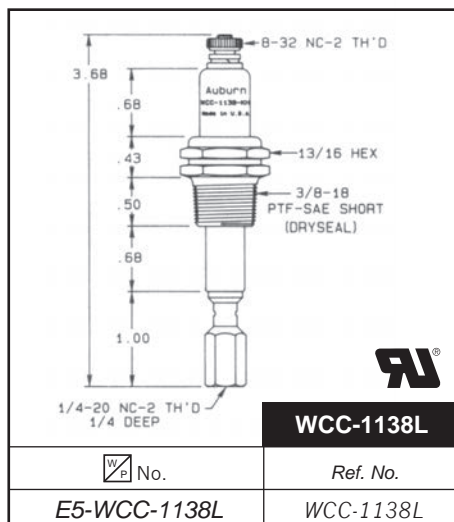
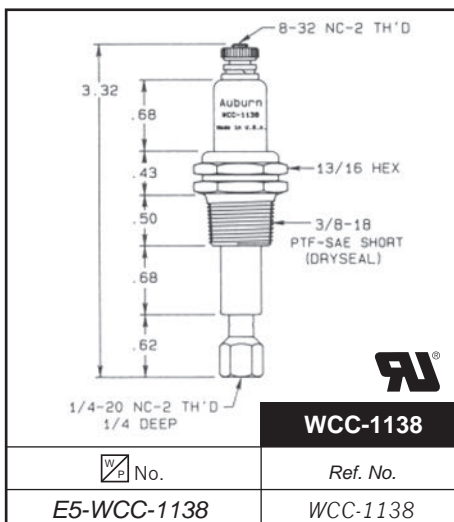
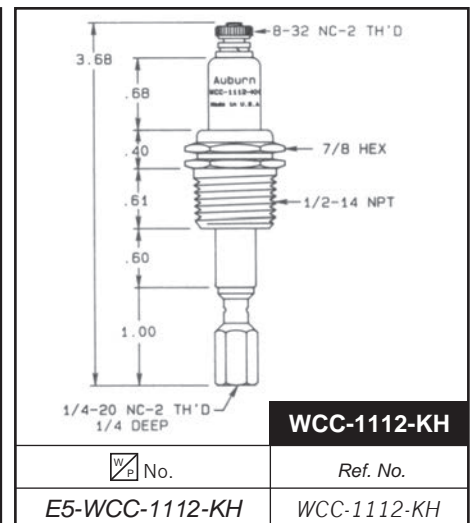
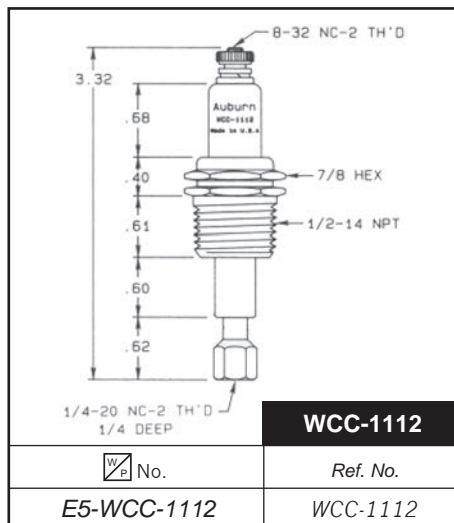
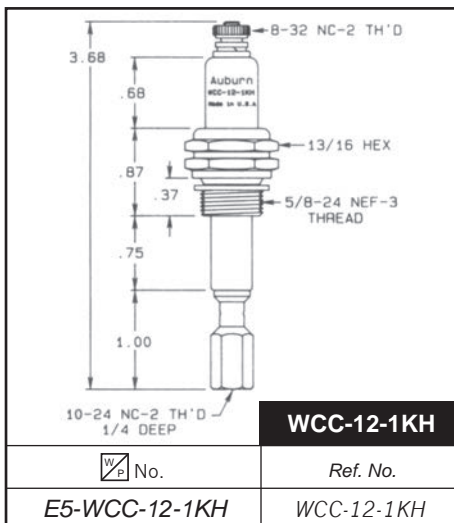
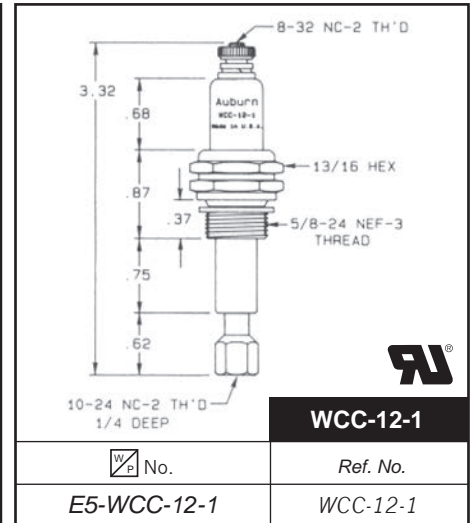
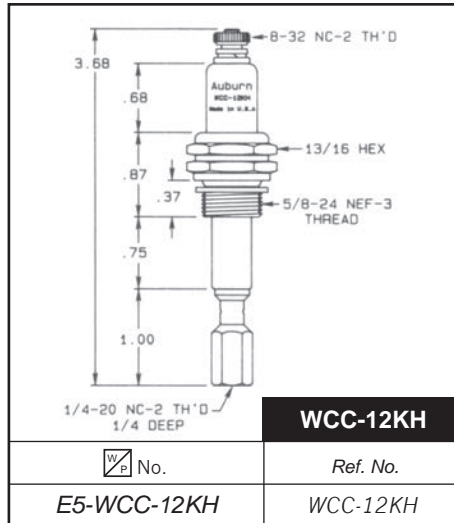
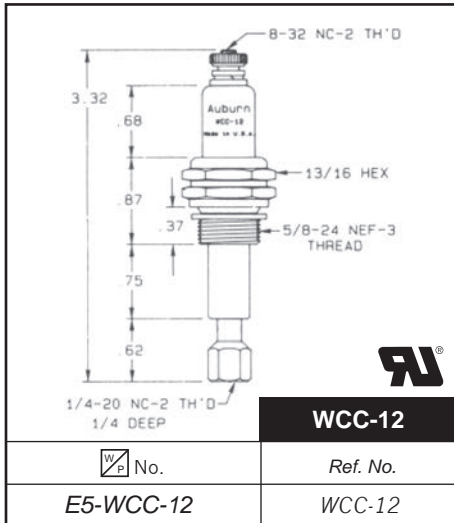

AUBURN LIQUID LEVEL ELECTRODES

WCT Series:

Metal parts are 303 or 304 non-magnetic stainless steel, center electrodes are one piece.

Non-steam applications up to 1,000 PSI at 120° F or 0 PSI at 400° F

Steam applications up to 100 PSI at 337° F

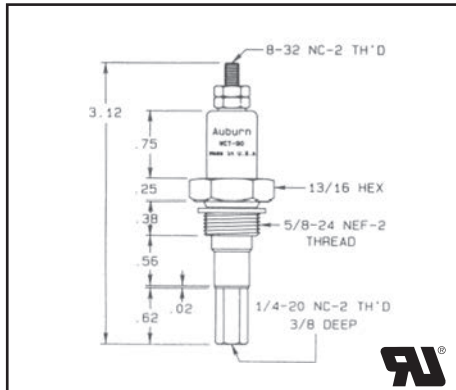

WCT-90

No.	Ref. No.
E5-WCT-90	WCT-90

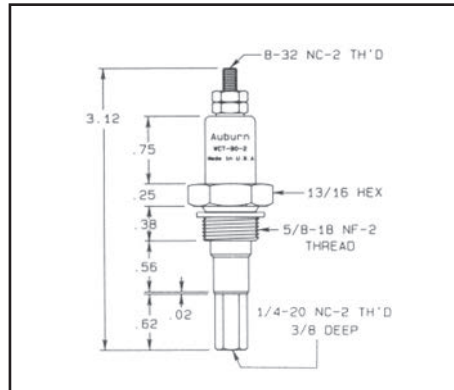

WCT-90-2

No.	Ref. No.
E5-WCT-90-2	WCT-90-2

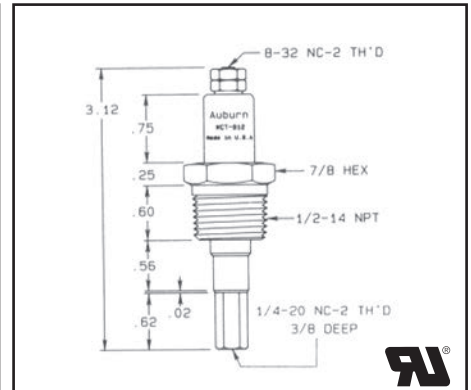

WCT-912

No.	Ref. No.
E5-WCT-912	WCT-912

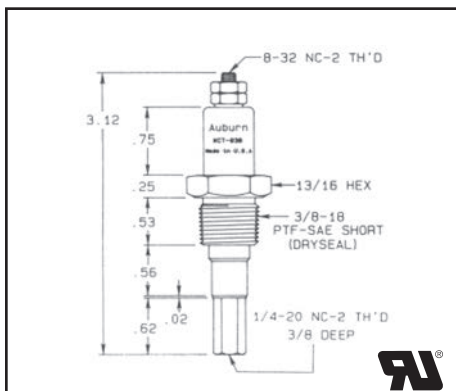

WCT-938

No.	Ref. No.
E5-WCT-938	WCT-938

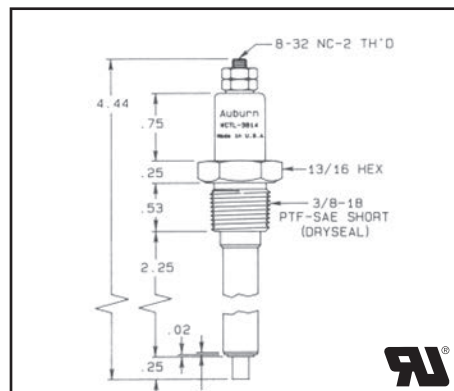

WCTL-3814

No.	Ref. No.
E5-WCTL-3814	WCTL-3814

As a major distributor of Auburn Liquid Level Electrodes, Westwood can special order any Auburn item not shown in this catalog and get it to you fast!



LIQUID LEVEL PROBES for FULTON BOILERS on page H9

Please order by No.

Westwood

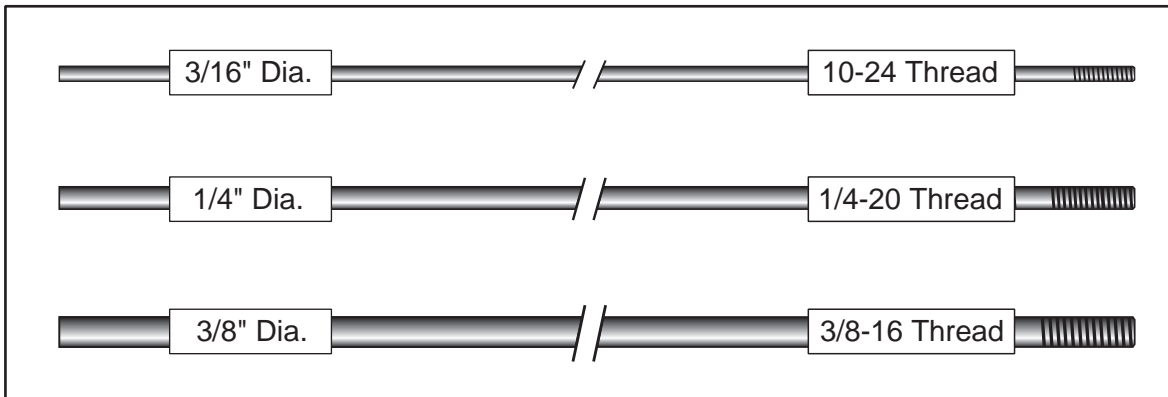
SOLID STAINLESS STEEL PROBES**FOR USE ON LIQUID LEVEL ELECTRODE ASSEMBLIES****STANDARD SIZES***

 No.	Ref. No.	Thread	Length	Diameter
E5-1024-12	1024-12	10-24	12"	3/16"
E5-1024-18	1024-18	10-24	18"	3/16"
E5-1024-24	1024-24	10-24	24"	3/16"
E5-1420-6	1420-6	1/4-20	6"	1/4"
E5-1420-12	1420-12	1/4-20	12"	1/4"
E5-1420-18	1420-18	1/4-20	18"	1/4"
E5-1420-24	1420-24	1/4-20	24"	1/4"
E5-1420-36	1420-36	1/4-20	36"	1/4"
E5-3816-12	3816-12	3/8-16	12"	3/8"
E5-3816-18	3816-18	3/8-16	18"	3/8"
E5-3816-24	3816-24	3/8-16	24"	3/8"

*Made to order non-standard lengths available by special order.



Take a look ...

LIQUID LEVEL PROBES for
FULTON BOILERS on page H9

Westwood

CHAMPION

IGNITION ASSEMBLIES



NOTE: Champion ignition assembly part numbers are now "E5-" followed by the former number.

Example:

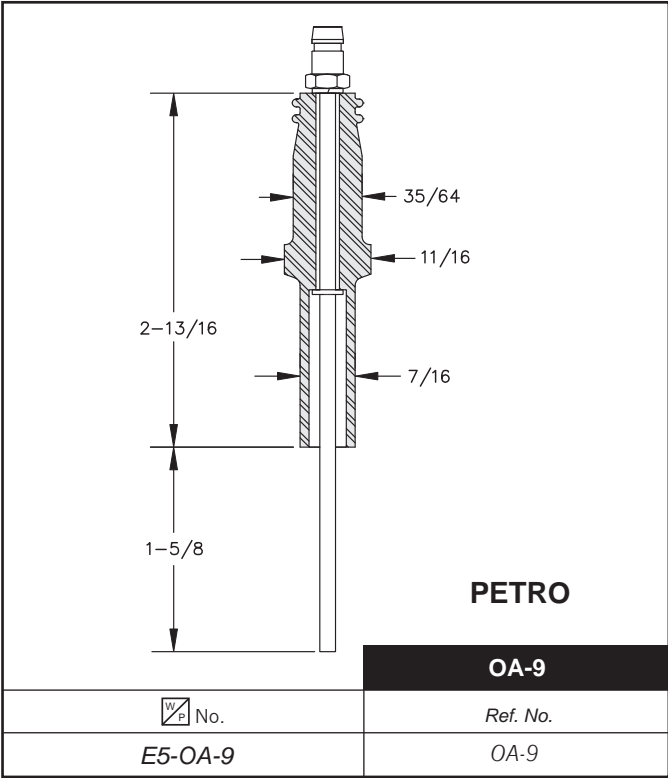
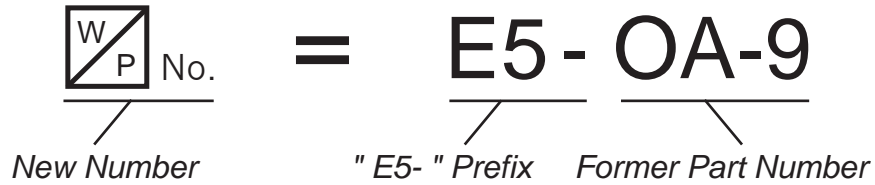

Please order by No.

Westwood

CHAMPION

**IGNITION
ASSEMBLIES**

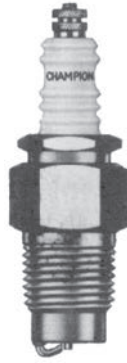

A-25

No.

Ref. No.

E5-A-25

A-25



CJ-8

No.

Ref. No.

E5-CJ-8

CJ-8

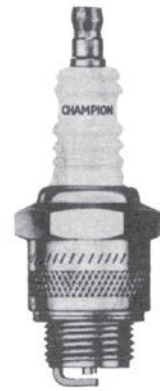

D-9

No.

Ref. No.

E5-D-9

D-9



D-89D

No.

Ref. No.

E5-D-89D

D-89D



H14Y

No.

Ref. No.

E5-H14Y

H14Y



J-99

No.

Ref. No.

E5-J-99

J-99



K97F

No.

Ref. No.

E5-K97F

K97F



UY-6

No.

Ref. No.

E5-UY-6

UY-6



W18

No.

Ref. No.

E5-W18

W18



W-95D

No.

Ref. No.

E5-W-95D

W-95D



Z-6

No.

Ref. No.

E5-Z-6

Z-6



TERMINALS

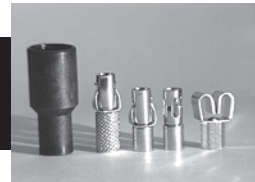

SPECIAL NOTE: NEW **Rajah™** TERMINAL PART NUMBERS

Rajah™ terminals and related items part numbers are now "E9-" followed by the former part number.

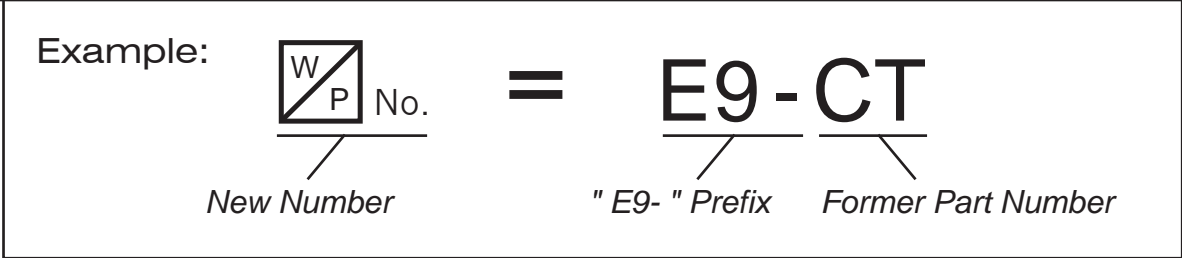

Note: Terminal part number endings of 6-32, 8-32, 10-24, and 10-32 refer to terminal thread size

 No. E9-CT	 No. E9-SS	 No. E9-R-2	 No. E9-SF	 No. E9-TT
 No. E9-CT-TS 8-32 E9-CT-TS 10-32	 No. E9-SS-TS 10-32	 No. E9-SR	 No. E9-HS 6-32 E9-HS 10-32	 No. E9-CT-BS 6-32 E9-CT-BS 8-32 E9-CT-BS 10-32
 No. E9-SS-BS 6-32 E9-SS-BS 8-32 E9-SS-BS 10-32	 No. E9-HT 6-32 E9-HT 8-32 E9-HT 10-32	 No. E9-SX-1 6-32 E9-SX-1 10-32	 No. E9-CT-SS	 No. E9-ACT
 No. E9-ASS	 No. E9-CHT	 No. E9-BS 6-32 E9-BS 8-32 E9-BS 10-24 E9-BS 10-32	 No. E9-458-9 10-32	 No. E9-RAC
 No. E9-RASS	 No. E9-EBS 6-32 E9-EBS 10-32	 No. E9-457-6 6-32	 No. E9-SS-SOS	 No. E9-R-SOS

Please order by No.



TERMINALS



Note: Terminal part number endings of 6-32, 8-32, 10-24, and 10-32 refer to terminal thread size







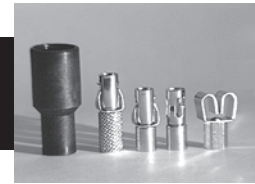







 <p><input checked="" type="checkbox"/> No. E9-T-SOS</p>	 <p><input checked="" type="checkbox"/> No. E9-AS-SOS</p>	 <p><input checked="" type="checkbox"/> No. E9-BS-SOS</p>	 <p><input checked="" type="checkbox"/> No. E9-SSN</p>	 <p><input checked="" type="checkbox"/> No. E9-RSN</p>
 <p><input checked="" type="checkbox"/> No. E9-TSN</p>	 <p><input checked="" type="checkbox"/> No. E9-ASN</p>	 <p><input checked="" type="checkbox"/> No. E9-BSN</p>	 <p><input checked="" type="checkbox"/> No. E9-ACT-BS 6-32 E9-ACT-BS 10-32</p>	 <p><input checked="" type="checkbox"/> No. E9-DS-1</p>
 <p><input checked="" type="checkbox"/> No. E9-FF-1</p>	 <p><input checked="" type="checkbox"/> No. E9-CC-1</p>	 <p><input checked="" type="checkbox"/> No. E9-SS-LBS</p>	 <p><input checked="" type="checkbox"/> No. E9-SS-LTS</p>	 <p><input checked="" type="checkbox"/> No. E9-XC</p>
 <p><input checked="" type="checkbox"/> No. E9-SA-1 6-32</p>	 <p><input checked="" type="checkbox"/> No. E9-ITN 8-32 E9-ITN 10-32</p>	 <p><input checked="" type="checkbox"/> No. E9-ITN-S 6-32 E9-ITN-S 8-32</p>	 <p><input checked="" type="checkbox"/> No. E9-TC-10</p>	 <p><input checked="" type="checkbox"/> No. E9-TS-10</p>
 <p><input checked="" type="checkbox"/> No. E9-R-1</p>	 <p><input checked="" type="checkbox"/> No. E9-RS-3 10-32</p>	 <p><input checked="" type="checkbox"/> No. E9-RX-4 6-32 E9-RX-4 8-32 E9-RX-4 10-32</p>	 <p><input checked="" type="checkbox"/> No. E9-RX-5 10-32</p>	 <p><input checked="" type="checkbox"/> No. E9-RP-6</p>
 <p><input checked="" type="checkbox"/> No. E9-RC-5</p>	 <p><input checked="" type="checkbox"/> No. E9-RE-7</p>	 <p><input checked="" type="checkbox"/> No. E9-AEBF</p>	 <p><input checked="" type="checkbox"/> No. E9-EBF</p>	 <p><input checked="" type="checkbox"/> No. E9-B-10 10-32 5/16" Long</p>
 <p><input checked="" type="checkbox"/> No. E9-B-11 10-32 1 1/16" Long</p>	 <p><input checked="" type="checkbox"/> No. E9-BC-11</p>	 <p><input checked="" type="checkbox"/> No. E9-BS-12</p>		







TERMINALS

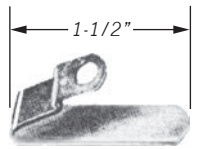
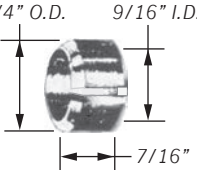
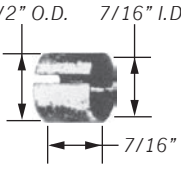
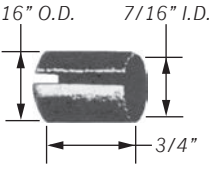
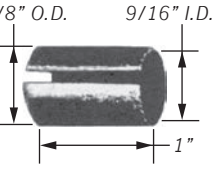

Note: Terminal part number endings of 6-32, 8-32, 10-24, and 10-32 refer to terminal thread size

 No. E9-S-15 10-32	 No. E9-AL-10	 No. E9-AS-10	 No. E9-ASC	 No. E9-S-10
 No. E9-CS	 No. E9-YL-10	 No. E9-YS-10	 No. E9-YSC	 No. E9-SCS-2 6-32 1-1/8" Long
 No. E9-SCS-1 10-32 1-1/4" Long	 No. E9-KBN 6-32 E9-KBN 10-24	 No. E9-DT		<i>Cleaver Brooks Spring Connects plate assembly to ignitors - 20" Long</i> No. E9-CBS

SPECIALTY TERMINAL & ELECTRODE HARDWARE

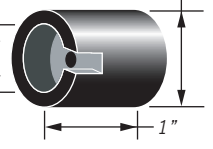
 No. E9-686 BAR 1-1/2"	 No. E9-BB 3/4" O.D. 9/16" I.D. 7/16"	 No. E9-PB 1/2" O.D. 7/16" I.D. 7/16"	 No. E9-AB 9/16" O.D. 7/16" I.D. 3/4"	 No. E9-DB 5/8" O.D. 9/16" I.D. 1"
 No. E9-CBR 3/4" O.D. - 9/16" I.D. 1/16" Thick	 No. E9-467 GASKET 3/4" O.D. - 9/16" I.D. 1/16" Thick	 No. E9-I-18 GASKET 3/4" O.D. - 9/16" I.D. 1/32" Thick	 No. E9-500 SHIELD 19/32" I.D. 3/4" O.D. 1"	

BUSS BARS

 No.	Ref. No.	12" Length*
E9-TYPE ET	Type ET	Round brass with eyelet and 6-32 thread
E9-TYPE F	Type F	Flat brass with 1/8" hole
E9-TYPE ST	Type ST	Round brass with 6-32 thread

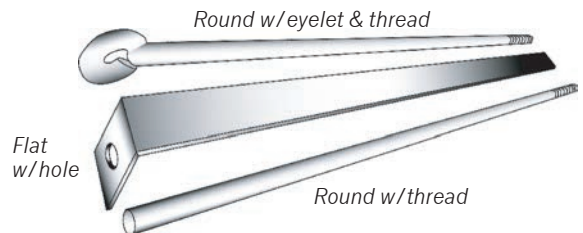



* Other lengths available up to 24"

Please order by  No.

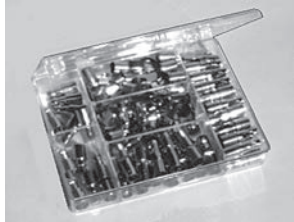

IGNITION TERMINAL KITS



 No.	Ref. No.	Description
E9-34	34	Rajah™ "Mini" Ignition Terminal Kit:
		20 - CT Cage Terminals 12 - SS Spring Snap Terminals 20 - R2 Ring Terminals 10 - RAC Right Angle Cage Terminals 12 - SF Stud Ferrule Terminals
E9-54	54	Rajah™ Transformer Terminal Kit:
		6 - AS-10 Short Adapter Spring 6 - AL-10 Long Adapter Spring 2 - STS-10 Thumb Nut on Cage 2 - 458-9 Spring Plunger (10-32) 4 - B-10 Button Contact (short) 2 - B-11 Button Contact (long) 6 - CC-1 Cage on Cage 6 - RC-5 Ram's Horn on Cage 4 - RX4 Ram's Horn on Hex 2 - R1 Ram's Horn Clip 6 - HS Hollow Stud (10-32) 6 - SX Hex Stud (10-32)
E9-2097	2097	Rajah™ "Pro" Ignition Terminal Kit:
		24 - CT Cage Terminals 24 - SS Spring Snap Terminals 24 - R2 Ring Terminals 24 - SF Stud Ferrule Terminals 24 - RAC Right Angle Cage Terminals 100 - DT Distributor Terminals 24 - FF-1 Ferrule on Ferrule 1 - T200-10 (former #695) Terminal Crimping Tool
E9-3500	3500	Rajah™ "Deluxe" Ignition Terminal Kit:
		12 - CT Cage Terminals 12 - SS Spring Snap Terminals 12 - R2 Ring Terminals 12 - ACT Angle Cage Terminals 12 - SF Stud Ferrule Terminals 12 - BS Base Stud (6-32) 12 - BS Base Stud (10-32) 12 - HS Hollow Stud (6-32) 12 - HS Hollow Stud (10-32) 12 - CC-1 Cage on Cage 12 - CT-TS Cage on Stud (10-32) 12 - RC-5 Ram's Horn on Cage 12 - R-1 Ram's Horn Clip 12 - #299 Special GE Slotted Stud 12 - SX Hex Stud (10-32) 1 - 1/4" Nut Driver 1 - 5/16" Nut Driver 1 - T200-10 (former #695) Terminal Crimping Tool
E9-CK-1	CK-1	Rajah™ Carlin Transformer Contact Kit:
		For in the field conversion on Carlin Burner models 98, 99, 100, 101, 102 Webster transformer model 313-28AB85 2 - Contact clips 2 - Flat washers (#10) 2 - Shakeproof washers (#10) 2 - 10-32 nuts

ELECTRICAL CLIPS & RUBBER BOOTS

 <p> No. E9-LV CLIP</p>	<p><i>Vinyl</i></p>  <p> No. E9-LV BOOT</p>	 <p> No. E9-20 AMP CLIP</p>	<p><i>Vinyl</i></p>  <p> No. E9-20 AMP BOOT</p>
<p><i>Distributor nipple</i></p>  <p> No. E9-DN</p>	<p><i>Silicone Rubber</i></p>  <p> No. E9-250 BOOT</p>	<p><i>Silicone Rubber</i></p>  <p> No. E9-251 BOOT</p>	



Take a look ...

JUMPERS & CORD CLIP SETS on page T13

HIGH TEMPERATURE CERAMIC SPARK PLUG BOOTS with Stainless Steel Terminals

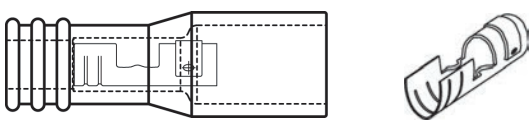
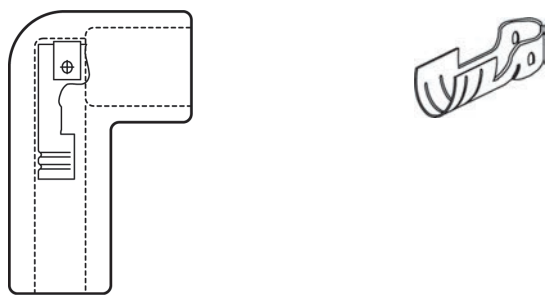
 No.	Ref. No.	Description
<i>E9-ECF</i>	<i>ECF</i>	<p><i>EXTENDED CERAMIC BOOT - with stainless steel terminal for 7mm ignition wire</i></p> 
<i>E9-AECF</i>	<i>AECF</i>	<p><i>ANGLE EXTENDED CERAMIC BOOT - with stainless steel terminal for 7mm ignition wire</i></p> 

Westwood IGNITION CABLE

Cable Type	UL LISTED	W/P No.		
		25' Roll	100' Roll	1,000' Roll
GTO-15	Yes	E60-25	E60-100	E60-1000
HV-15	-	E61-25	E61-100	E61-1000
White Silicone	-	E62-25	E62-100	-
Red Silicone	Yes	E63-25	E63-100	E63-1000

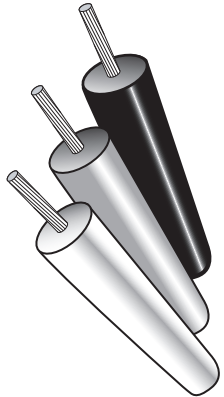

GTO-15 (black)	Large .275" outside diameter fits Rajah terminals perfectly. Withstands more than 15,000 VAC with low current leakage. Resists arc-over, tracking, and burning. Tested to withstand conditions of heat, oil, and moisture. No. 14 gauge, 19 x 26 stranded tinned copper wire. All vinyl insulation affords low temperature flexibility. Flame retardant, will not support combustion. Tough and abrasion resistant, yet easy stripping. Temperature range: -40 ⁰ F to 140 ⁰ F (-20 ⁰ C to 60 ⁰ C)
HV-15 (black)	Large .275" outside diameter fits Rajah terminals perfectly. Withstands more than 15,000 VAC with low current leakage. Resists arc-over, tracking, and burning. Tested to withstand conditions of heat, oil, and moisture. No. 16 gauge, 19 x 29 stranded bare copper wire. All vinyl insulation affords low temperature flexibility. Flame retardant, will not support combustion. Tough and abrasion resistant, yet easy stripping. Temperature range: -40 ⁰ F to 194 ⁰ F (-20 ⁰ C to 90 ⁰ C)
White Silicone	Large .275" outside diameter fits Rajah terminals perfectly. Withstands more than 10,000 VAC and 25,000 VDC with low current leakage. No. 16 gauge, 19 x 26 stranded tinned copper wire. Natural Silicone insulation, high dielectric strength. Temperature range: -65 ⁰ F to 400 ⁰ F (-54 ⁰ C to 204 ⁰ C)
Red Silicone	Large .275" outside diameter fits Rajah terminals perfectly. Withstands more than 10,000 VAC and 25,000 VDC with low current leakage. No. 16 gauge, 19 x 26 stranded nickel plated copper wire. Natural Silicone insulation, high dielectric strength. Temperature range: -65 ⁰ F to 482 ⁰ F (-54 ⁰ C to 250 ⁰ C)

CABLE ASSEMBLIES and FIBERGLAS BRAID

W/P No.	Ref. No.	Description
E64	#3250	Red Silicone wire high temperature cable assembly with protective metal braid . Temperature range -65 ⁰ F to 450 ⁰ F. Overall length is 32-1/2".
E64-5	#RS-3350	Red Silicone wire high temperature cable assembly with red Silicone boots . Temperature range -65 ⁰ F to 450 ⁰ F. Withstands 10,000 VAC / 25,000 VDC . Overall length is 33-1/2".
E64-20	#3253	Fiberglas braided sleeving. Fits over ignition cable for high temperature protection. Sold by the foot. (Ordering example: For 5' of sleeving order 5 of E64-20. Shipped as one piece)

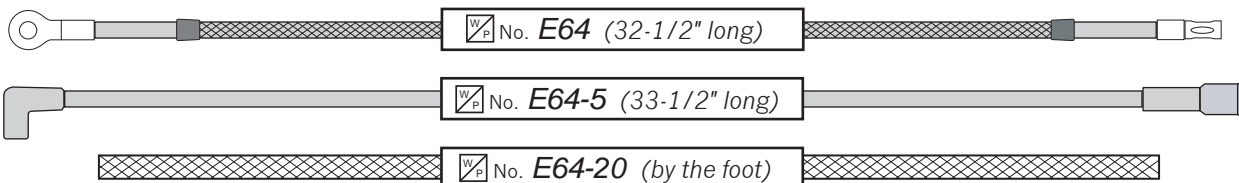

ELECTRICAL ACCESSORIES



SOLDERLESS TERMINAL KIT

No. **E70**

Contains 175 of the most popular terminals and connectors

KIT REFILL TERMINALS - Part numbers are for a package of the quantity indicated

 AWG: 22-16 Female .250 Tab No. E70-10	 AWG: 22-16 Ring #6 Stud No. E70-20	 AWG: 16-14 Ring #8 Stud No. E70-21	 AWG: 16-14 Spade #8 Stud No. E70-34	 AWG: 16-14 Spade #10 Stud No. E70-36	 AWG: 22-16 Butt Connector No. E70-40
BACK ROW - All Packages of 100					
 AWG: 16-14 Female .250 Tab No. E70-12	 AWG: 22-16 Ring #10 Stud No. E70-22	 AWG: 16-14 Ring #10 Stud No. E70-23	 AWG: 16-14 Spade #6 Stud No. E70-30	 AWG: 22-16 Spade #6 Stud No. E70-32	 AWG: 16-14 Butt Connector No. E70-42
MIDDLE ROW - Packages of 100					Pkg. of 50
 AWG: 12-10 Female .250 Tab No. E70-14	 AWG: 12-10 Ring #10 Stud No. E70-24	 AWG: 12-10 Ring 1/4" Stud No. E70-25	 AWG: 12-10 Ring 5/16" Stud No. E70-26	 AWG: 12-10 Spade #10 Stud No. E70-38	 AWG: 12-10 Butt Connector No. E70-44
FRONT ROW - All Packages of 50					

WIRE CONNECTORS - Part numbers are for a package of 100

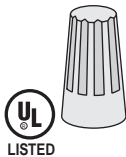

	<i>GREY</i>	<i>BLUE</i>	<i>ORANGE</i>	<i>YELLOW</i>	<i>RED</i>
No.	E70-50	E70-52	E70-54	E70-56	E70-58

CABLE TIES - Part numbers are for a package of 100

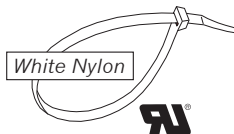

	4"	5-1/2"	7-1/2"	11"	14-1/2"
No.	E70-60	E70-62	E70-64	E70-66	E70-68

ROUGH SERVICE BULBS

Part numbers are for a box of 2 bulbs

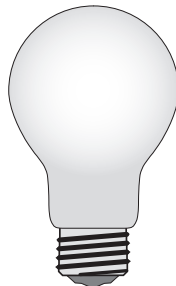

	75 Watt	100 Watt
No.	E70-75	E70-100



Please order by No.

Westwood
CAD CELL FLAME DETECTORS

UNIVERSAL REPLACEMENT FOR HONEYWELL AND WHITE-RODGERS

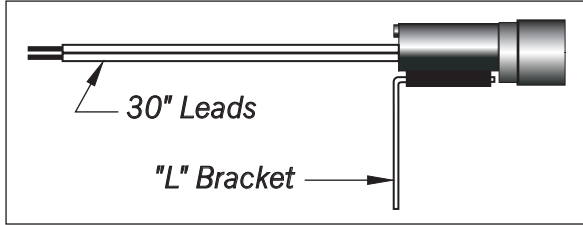

No. **E80**

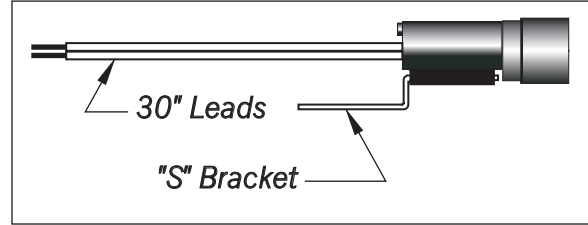

No. **E80-1**

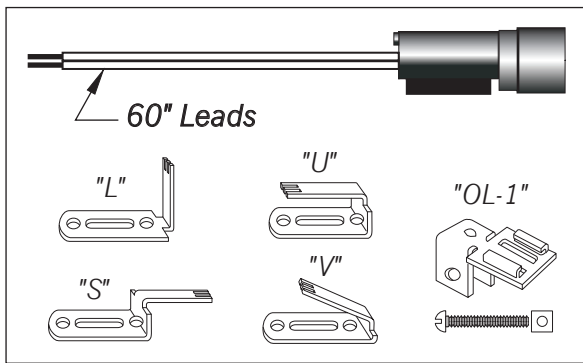

No. **E80-2**

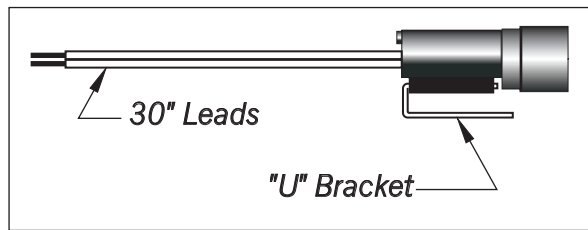

No. **E80-3**

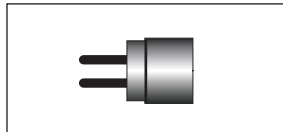

No. **E81**

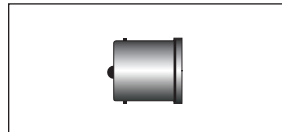

No. **E81-10**

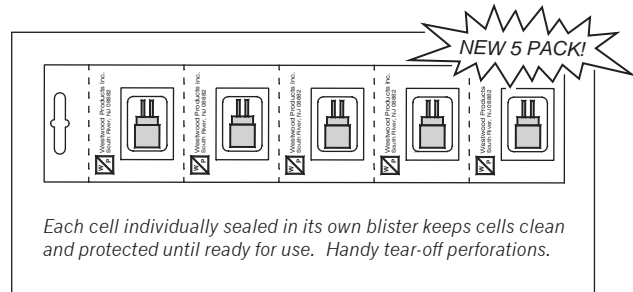

No. **E81-5**

No.	Ref. No.	Description
E80	TM-30L	Complete flame detector with cad cell eye*, 30" leads, "L" bracket, poly bag package
E80-1	TM-30S	Complete flame detector with cad cell eye*, 30" leads, "S" bracket, poly bag package
E80-2	TMK-60	Complete flame detector kit with cad cell eye*, 60" leads, "L" bracket, "S" bracket, "U" bracket, "V" bracket, "OL-1" special oil line bracket with mounting screw and nut, packaged in a box
E80-3	-	Complete flame detector with cad cell eye*, 30" leads, "U" bracket, poly bag package
E81	Type M	Cad cell eye* packaged in a box
E81-5	-	Cad cell eye* 5 pack (blister card with 5 E81-5 eyes per card), tear-off perforations
E81-10	Type W	Cad cell eye, bayonet mount for White-Rodgers cad cell flame detector, packaged in a box

* Cad cell eye replaces Honeywell 130367 and fits C554A flame detector



T70 Cad cell relay and eye tester on page T11

THERMOSTAT GUARDS

METAL AND PLASTIC TAMPER PROOF DESIGNS IN PLEASING COLORS

*Designed for use in schools, industrial plants and military installations where **rugged, maximum protection** is the first consideration. The louvered covers cannot be twisted or jammed open. Bobby pins, pencils, letter openers and other such objects cannot be inserted through the cover to adjust the thermostat.*

- ▶ Metal guards are constructed of 18-22 gauge steel with a baked enamel finish
- ▶ Plastic guards are molded from hi-impact plastic and can be used with both horizontally or vertically mounted thermostats
- ▶ All guards come with eight tumbler lock, one key, and mounting hardware
- ▶ Guards with ring bases can be installed without removing the thermostat



No. **E140**



No. **E140-1**

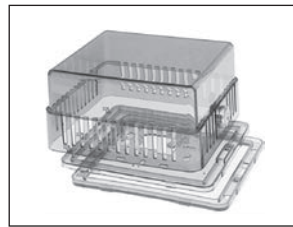

No. **E141**

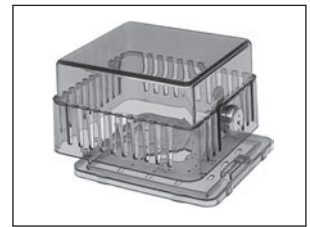

No. **E142**

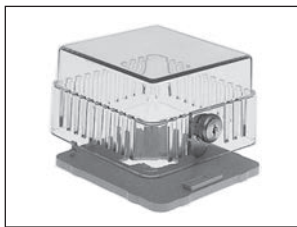

No. **E142-1**



No. **E142-2**



No. **E142-3**

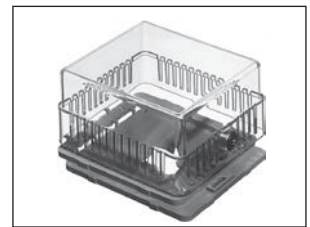

No. **E143**

No.	Ref. No.	Inside Dimensions H" x W" x D"	Mat'l	Color	Base	Comments
E140	WTG-54VL	6-1/4 x 4-3/4 x 3	M	BE	SH	T80, T90, T91, T199, T330, T340, T42, T26, T87, T92, T651, T921, T872, T882
E140-1	WTG-54VLW	6 x 3-13/16 x 3-1/8	M	BE	RH	
E141	WTG-B	5-1/4 x 4-5/8 x 3-1/4	P	BR	SR	T199, TP970, TP971, TP972, TP973, T26, T87, TS86, T832, T853, TP910
E142	WTG-EB	3-7/8 x 3-1/2 x 2-1/2	P	BR	S	
E142-1	WTG-EK	3-7/8 x 3-1/2 x 2-1/2	P	CL	S	
E142-2	WTG-EM	3-7/8 x 3-1/2 x 2-1/2	M	BE	S	
E142-3	WTG-EO	3-7/8 x 3-1/2 x 2-1/2	P	OP	S	
E143	WTG-K	5-1/4 x 4-5/8 x 3-1/4	P	CL	SR	

M=Metal
 P=Plastic
 BE=Beige
 BR=Bronze
 CL=Clear
 OP=Opaque
 WH=White
 H=Hinged
 R=Ring
 S=Solid

Please order by No.

THERMOSTAT GUARDS (CONTINUED)

METAL AND PLASTIC TAMPER PROOF DESIGNS IN PLEASING COLORS

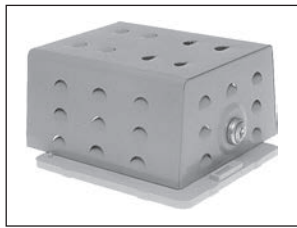

No. **E143-1**

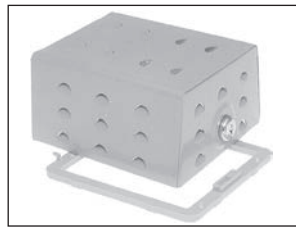

No. **E143-2**

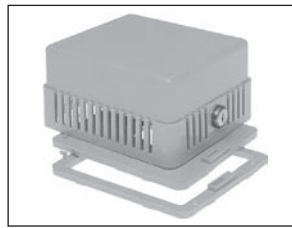

No. **E143-3**

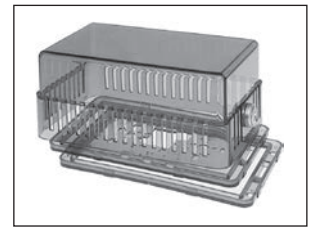

No. **E144**

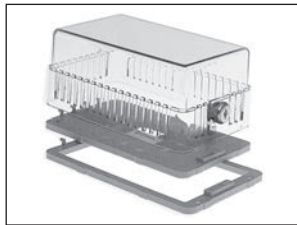

No. **E144-1**

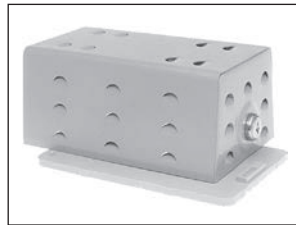

No. **E144-2**

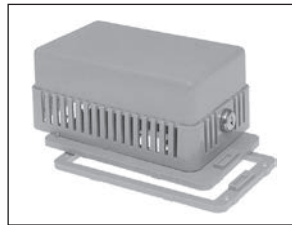

No. **E144-3**

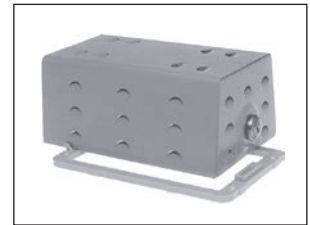

No. **E144-4**

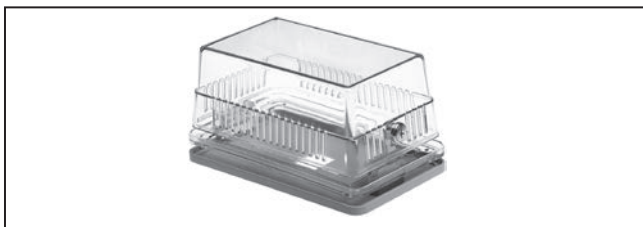

No. **E145 Series**

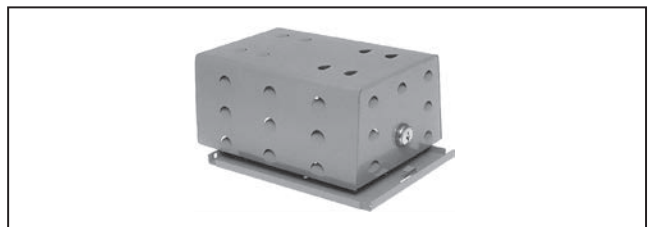

No. **E146**

No.	Ref. No.	Inside Dimensions H" x W" x D"	Mat'l	Color	Base	Comments	
E143-1	WTG-KM	5-1/4 x 4-5/8 x 3	M	BE	S	T80, T90, T91, T99, T199, T330, T340, T42, TA42, T26, TS86, T87, T92, T498, T651, T834, T921, T872, T882	
E143-2	WTG-KWM	5-1/4 x 4-5/8 x 3-1/4	M	BE	R		
E143-3	WTG-O	5-1/4 x 4-5/8 x 3-1/4	P	OP	SR		
E144	WTG-RB	6-3/8 x 3-1/2 x 3-1/4	P	BR	SR		
E144-1	WTG-RK	6-3/8 x 3-1/2 x 3-1/4	P	CL	SR		
E144-2	WTG-RM	6-3/8 x 3-1/2 x 3	M	BE	S		
E144-3	WTG-RO	6-3/8 x 3-1/2 x 3-1/4	P	OP	SR		
E144-4	WTG-RWM	6-3/8 x 3-1/2 x 3-1/4	M	BE	R		
E145	WTG-UB2	8-1/8 x 4-5/8 x 3-5/8	P	BR	SR		General, White-Rodgers, Barber Colman, Honeywell, Robertshaw, Camstat, Penn
E145-1	WTG-UK2	8-1/8 x 4-5/8 x 3-5/8	P	CL	SR		
E146	WTG-UM	7-1/4 x 5-3/8 x 3-1/2	M	BE	S		

M=Metal
 P=Plastic
 BE=Beige
 BR=Bronze
 CL=Clear
 OP=Opaque
 WH=White
 H=Hinged
 R=Ring
 S=Solid

THERMOSTAT GUARDS (CONTINUED)

METAL AND PLASTIC TAMPER PROOF DESIGNS IN PLEASING COLORS

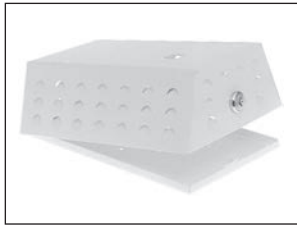

No. **E147 Series**

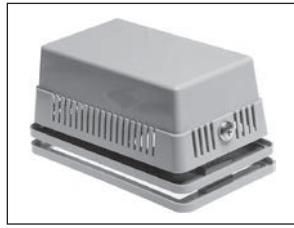

No. **E148**

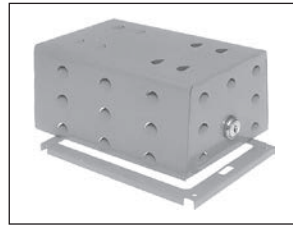

No. **E149**

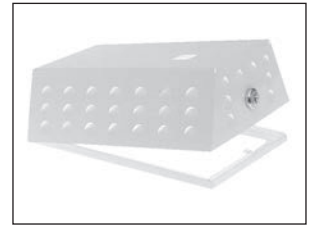

No. **E150 Series**

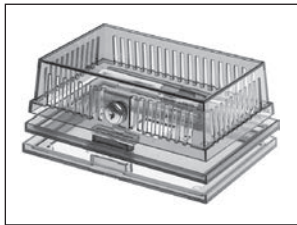

No. **E151**

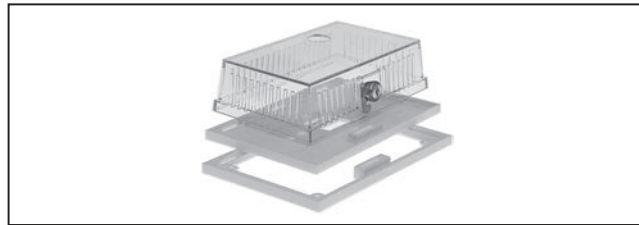

No. **E151-1, -2**

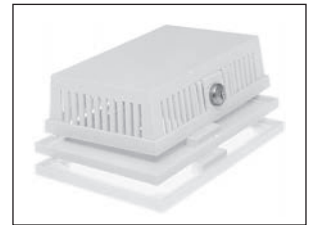

No. **E151-3**

No.	Ref. No.	Inside Dimensions H" x W" x D"	Mat'l	Color	Base	Comments
E147	WTG-UM1	9-3/8 x 6-3/4 x 3	M	WH	SH	Honeywell T7300 series
E147-1	WTG-UM1DH	9-3/8 x 6-3/4 x 3	M	WH	SH	Honeywell T7300 series w/display opening
E147-2	WTG-UM1DOH	9-3/8 x 6-3/4 x 3	M	WH	SH	Honeywell T7300 series w/override/display opening
E147-3	WTG-UM1DOWR	9-3/8 x 6-3/4 x 3	M	WH	SH	White-Rodgers IF90 series w/override/display opening
E147-4	WTG-UM1OH	9-3/8 x 6-3/4 x 3	M	WH	SH	Honeywell T7300 series w/override opening
E147-5	WTG-UM1SDH	9-3/8 x 6-3/4 x 3	M	WH	SH	Honeywell T7400 series w/display opening
E148	WTG-UO2	8-1/8 x 4-5/8 x 3-5/8	P	OP	SR	
E149	WTG-UWM	6-3/4 x 4-1/4 x 3-9/16	M	BE	R	
E150	WTG-UWM1	9-3/8 x 6-3/4 x 3	M	WH	RH	Honeywell T7300 series
E150-1	WTG-UWM1DH	9-3/8 x 6-3/4 x 3	M	WH	RH	Honeywell T7300 series w/display opening
E150-2	WTG-UWM1DOH	9-3/8 x 6-3/4 x 3	M	WH	RH	Honeywell T7300 series w/override/display opening
E150-3	WTG-UWM1DOWR	9-3/8 x 6-3/4 x 3	M	WH	RH	White-Rodgers IF90 series w/override/display opening
E150-4	WTG-UWM1OH	9-3/8 x 6-3/4 x 3	M	WH	RH	Honeywell T7300 series w/override opening
E150-5	WTG-UWM1SDH	9-3/8 x 6-3/4 x 3	M	WH	RH	Honeywell T7400 series w/display opening
E151	WTG-DB	4-1/8 x 7-1/16 x 2-1/4	P	BR	SR	
E151-1	WTG-DK	4-1/8 x 7-1/16 x 2-1/4	P	CL	SR	
E151-2	WTG-DK1	4-1/8 x 7-1/16 x 2-1/4	P	CL	SR	w/override opening
E151-3	WTG-DO	4-1/8 x 7-1/16 x 2-1/4	P	OP	SR	

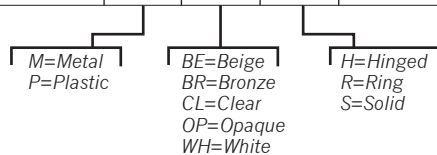

Please order by No.

ULTRAGLO™ Thermostat Light

Mounts anywhere!

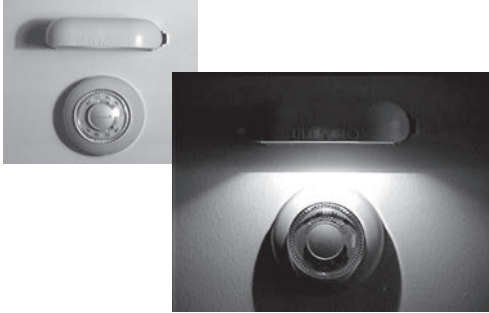

This easy to mount battery powered light has an ultra bright bulb that draws little current. It can be mounted in any convenient location with the two mounting screws provided. Easily slips out of its mounting bracket for use as a hand light. Use in cars, boats, RVs and campers too!

 No. **E140-40**

REPLACEMENT ZONE VALVE MOTOR

For motor driven OPEN, spring return CLOSE valves
(ie. Erie, Flare, Honeywell, Superior)

**INSTALLS WITHOUT REMOVING VALVE FROM PIPING
USING EASY TO INSTALL EXTENDED BRASS SCREWS**

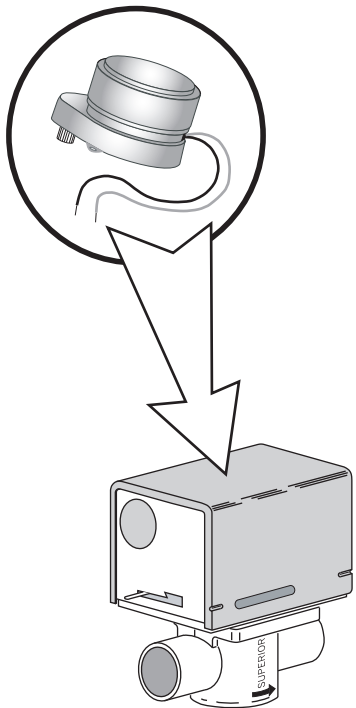

New easy to install screws!

 No.	Description
E180	Individually packaged with installation instructions, wire nuts, and easy to install extended brass mounting screws 24 VAC, 50/60 Hz, .32 A