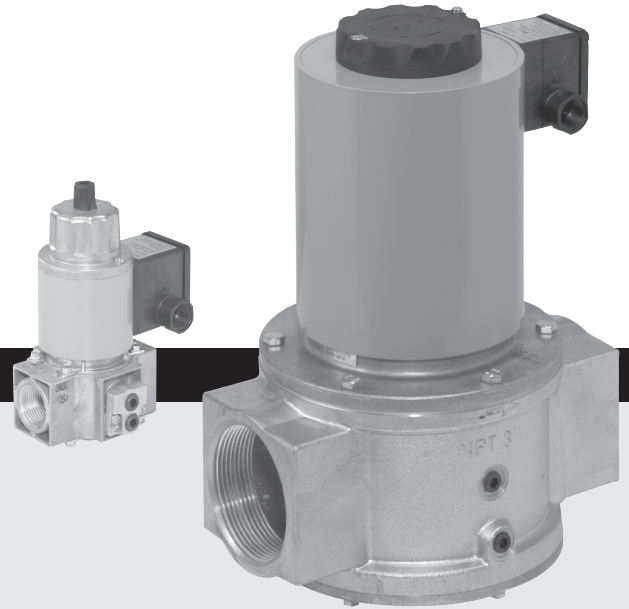

Table of Contents

Table of Contents Page 1
 Approvals Page 1
 Attention Page 1
 Specification Page 2
 Capacity Page 2
 Mounting Page 3
 Wiring Page 3
 Painting Valve Page 4
 Protection from Radiant Heat Page 4
 Multiple Burner & Pulse Fired Applications .. Page 4
 Valve Adjustment Page 4
 Valve Leakage Test Page 5
 Test Ports Page 6
 Flow Curve Page 7
 Accessories & Replacement Page 8



Approvals



UL Listed: File No. MH16727



CSA Certified: 1133914 & 1010989



FM Approved:
Report J.1.0V9A8.AF

Commonwealth of Massachusetts Approved Product Approval code G1-1107-35

Attention



The installation and maintenance of this product must be done under the supervision of an experienced and trained specialist. Never perform work if gas pressure or power is applied, or in the presence of an open flame.

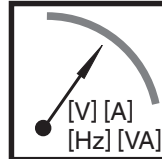

Check the ratings in the specifications to verify that they are suitable for your application.



Please read the instruction before installing or operating. Keep the instruction in a safe place. You find the instruction also at www.dungs.com. If these instructions are not heeded, the result may be personal injury or damage to property.



On completion of work on the safety shutoff valve, perform a leakage and function test.



Any adjustment and application-specific adjustment values must be made in accordance with the equipment manufacturers instructions.



This product is intended for installations covered by, but not limited to, the following codes and standards: NFPA 54, IFGC (International Fuel Gas Code), or CSA B149.1 (for Canada) or the following equipment codes and standards: CSD-1, ANSI Z83.18, ANSI Z83.4/CSA 3.7, ANSI Z21.13/CSA 4.9, or CSA B149.3 (for Canada).

Explanation of symbols

- 1, 2, 3 ... = Action
- = Instruction

Specification

MV	Normally closed automatic shutoff valve, fas opening, fast closing.
MVD	Normally closed automatic shutoff valve, fast opening, fast closing. Adjustable max. flow.
MVD	Normally closed automatic shutoff valve, slow opening, fast closing. Adjustable initial lift. Adjustable max. flow

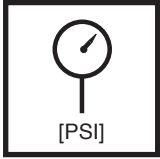

Max. Operating Pressure
 MVD 7 PSI (500 mbar) UL, FM;
 5 PSI (345 mbar) CSA
 MVDLE 3 PSI (200 mbar) UL, FM;
 2 PSI (140 mbar) CSA
Max. Closing Pressure
 15 PSI (1000 mbar) FM

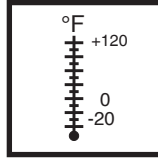

Ambient / Fluid Temperature
 -20 °F to +120 °F
 (-30 °C to +50 °C)



Electrical Ratings Available
 120 VAC / 60 Hz;
 24 VAC / 60 Hz in some models
 24 VDC (CSA)
Operating time
 100 % duty cycle

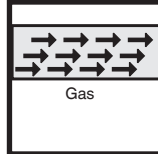

Gases
 Dry, natural gas, propane, butane;
 other noncorrosive gases. A "dry" gas
 has a dew point lower than +15 °F and
 its relative humidity is less than 60 %.
Materials in contact with Gas
 Housing: Aluminium and Steel
 Sealings on valve seats: NBR-based
 rubber.

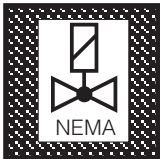

Enclosure Ratings Available
 NEMA Type 12

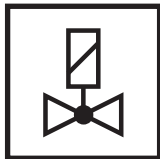

Position Indication (optional)
 Visual Indicator
 CPI400 SPDT valve switch with visual
 indication
Closing Time
 < 1 s
Opening Time
 MVD series: < 1 s
 MVDLE series: 10 to 20 s at 70 °F
Max. Flow Setting
(MVD and MVDLE only)
 Adjustable from <10 to 100 % of total
 flow; < 10 to 100 % of stroke
Initial Lift Adjustment
(MVDLE series only)
 Adjustable from 0 to 70 % of total flow;
 0 to 25 % of stroke

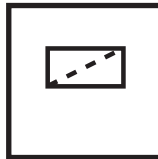

Strainer
 23 Mesh, installed in the housing
 upstream valve seat

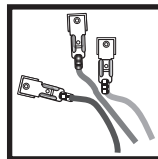

Electrical Connection
 Screw terminals with 1/2" NPT con-
 duct connection

Capacity

Capacity in CFH at pressure drop of 1 inch water column; natural gas, sp.gr. = 0.64

Valve Type	Size	CFH
MVD, MV 505 & MVDLE 205	1/2" NPT	250
MVD, MV 505 & MVDLE 207	3/4" NPT	575
MVD, MV 505 & MVDLE 210	1" NPT	825
MVD, MV 505 & MVDLE 212	1 1/4" NPT	1250
MVD 515 & MVDLE 215	1 1/2" NPT	1700
MVD 520 & MVDLE 220	2" NPT	2700
MVD 525 & MVDLE 225	2 1/2" NPT	3900
MVD 530 & MVDLE 230	3" NPT	5100

Mounting

Installation Position

Safety shutoff valve from vertically upright to horizontal.

 **If the flow is not in the same direction of the arrows, the valve will not operate properly.**

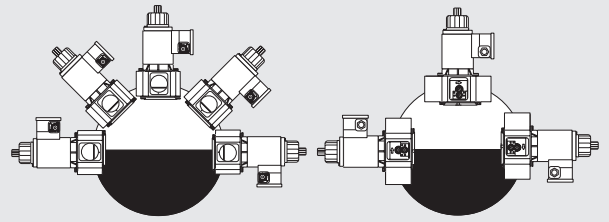

- Examine the valve for shipping damage.
- The main gas supply must be shut off before installation.
- The inside of the valve, threads and piping all must be clean and free of dirt. Failure to remove dirt/debris could result in valve damage or cause improper performance.

Recommended Piping Procedure

- Use new, properly reamed and threaded pipe free of chips.
- Apply good quality pipe sealant, putting a moderate amount on the male threads only. If pipe sealant lodges on the valve seat, it will prevent proper operation. If using LP gas, use pipe sealant rated for use with LP gas.
- Do not thread pipe too far. Valve distortion and/or malfunction may result from excess pipe in the valve body.
- Apply counter pressure only a parallel jaw wrench only to the flats on the flange when screwing the pipe into the flanges.
- Do not overtighten the pipe. Follow the maximum torque values listed below.
- After installation is complete, perform a leak test.
- When using the side taps, apply a max. torque of 7 Nm.

 **If the flow is not in the same direction of the arrows the valve will not operate properly.**

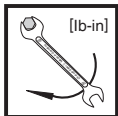
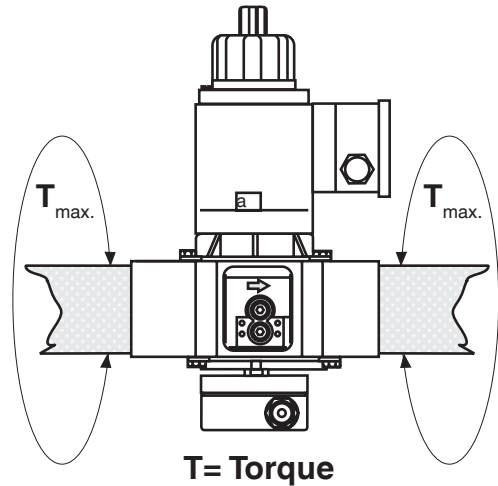

Recommended Torque for Piping	1/2"	3/4"	1"	1 1/4"	1 1/2"	2"	2 1/2"	3"	NPT pipe
		443	752	1106	1770	1991	2213	2876	3540

Wiring

Wiring Procedure

1. Remove the junction box cover to expose the three terminals.
2. The coil can be rotated to accommodate a conduit connection in any position.
3. Use only one of the knock-outs for connecting conduit to the junction box. Support the opposite side of the junction box when removing the knock-out.

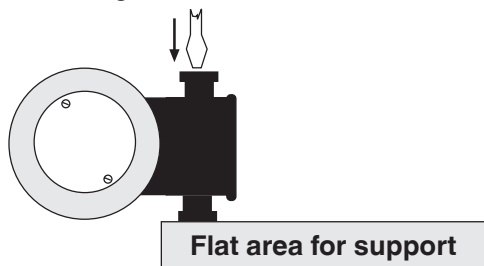

6. Make electrical connections to the terminals using the wiring diagram.

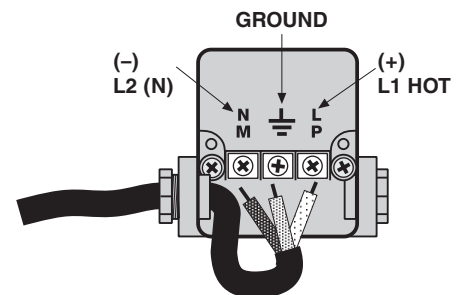

4. Run 14 or 16 guage wire rated for 95 °C(200 °F) through the conduit, and attach 1/2" NPT conduit to the junction box.
5. Use appropriate tools to connect the conduit fitting to the junction box.

7. Install a conduit plug at some point in the conduit run between the MVD junction box and closest panel that contains sparking contacts or other sparking devices (see NFPA 86 requirements).
8. Replace junction box cover.

 **All wiring must comply with local electrical codes, ordinances and regulations.**

Painting Valve

- It is not recommended that this valve be painted. Painting covers date codes and other labels that identify this valve.
- If the valve needs to be painted, a paint free of volatile organic components (VOC's) must be used. VOC's can damage valve o-rings, resulting in external gas leakage over time.
- During the painting process, use measures that will allow the valve's date code and other labeling information to be legible after the paint is dry.

Protection from Radiant Heat

- Radiant heat must be considered as a heat source that could result in an ambient temperature higher than the rating of this valve.
- Provide proper shielding to protect against radiant heat.

Multiple Burner & Pulse Fired Applications

On **multiple burner applications**, the following requirements apply:

- A manually operated shutoff valve shall be installed downstream of each individual burner safety shutoff valve.
- The backpressure on the individual burner safety shutoff valve shall be measured during the commissioning of the furnace to verify that while all other burners are firing and the individual burner safety shutoff valve shall is de-energized, the backpressure does not exceed 2 PSI. Measuring the backpressure shall also be repeated during purge and post purge. A pressure gauge can be used to measure the backpressure.

When using these valves on **pulse fired applications**, the following apply:

- Before installing the valve, the inside of all gas piping upstream to the nearest filter shall be cleaned, and that filter shall have an insert with mesh no larger than 50 micron.
- The valve shall be installed in the upright position.
- The valve shall be applied within all of its ratings. The type of gas, the ambient temperature, and the cycle rate of the valve are critical.
- The valve shall be leak tested as least annually.
- After the cycle life has been exceeded, the valve shall be immediately replaced.

Valve Adjustment

Max. Flow Setting

- The valves are factory set with the flow adjustment fully open.

⚠ Before igniting the burner, verify that gas flow at the factory setting does not create a light-off hazard.

1. Locate the flow adjustment on top of the valve [MVD (black knob) MVDLE (base of the hydraulic brake)]. There are two screws, the holding screw is recessed and has a blue sealing compound on it, while the pan head screw protrudes from the cap.
2. Loosen the pan head screw until you can freely rotate the flow adjustment.
3. Turn clockwise for less gas or counterclockwise for more gas. (see arrows on valve)
4. Check the flow at the burner with an orifice or flow meter.
5. Tighten the pan head screw on the adjustment cap.

Initial Lift Adjustment (MVDLE series only)

This adjustment can vary the initial flow between 0 % and 70 % of the total gas flow; 0 to 25 % of stroke. All MVDLE valves are factory set with no initial lift.

To adjust the initial lift:

1. Unscrew the small black cap on top of the flow adjustment cap to expose the initial lift adjustment knob.
2. The black cap also serves as a tool; turn the cap over and insert it on the slot on the adjustment knob.
3. Turn the knob clockwise for a min. initial lift or counterclockwise for a max. initial lift.
4. Once the desired initial fast lift has been achieved, reinstall the black cap.

⚠ Do not adjust or remove any screws or bolts which are sealed with a Red or Blue colored compound. Doing so will void all approvals and warranties.

Initial Lift Illustration (MVDLE series only)

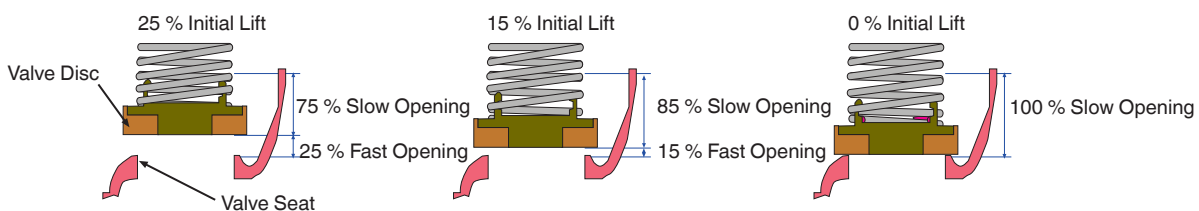

Valve Leakage Test

This leak test procedure tests the external sealing and valve seat sealing capabilities of two MVD and MVDLE automatic safety shutoff valves in series. Only qualified personnel should perform this test.

It is required that this test be done on the initial system startup, and then repeated at least annually. Possibly more often depending on the application, environmental parameters, and the requirements of the authority having jurisdiction.

Setup

This test requires the following:

- Test nipples installed in the downstream pressure tap port of each automatic safety shutoff valve to make the required 1/4" hose connection in step 4.
- A transparent glass of water filled at least 1 inch from the bottom.
- A proper leak test tube. An aluminum or copper 1/4" rigid tube with a 45° cut at the end that is then connected to a 1/4" flexible hose of some convenient length provides for a more accurate leakage measurement. However, a 45° cut at the end of the 1/4" flexible hose will suffice, but it will not likely be as accurate as the rigid tube.
- For detecting external leakages, an all purpose liquid leak detector solution or a soapy water solution is required.

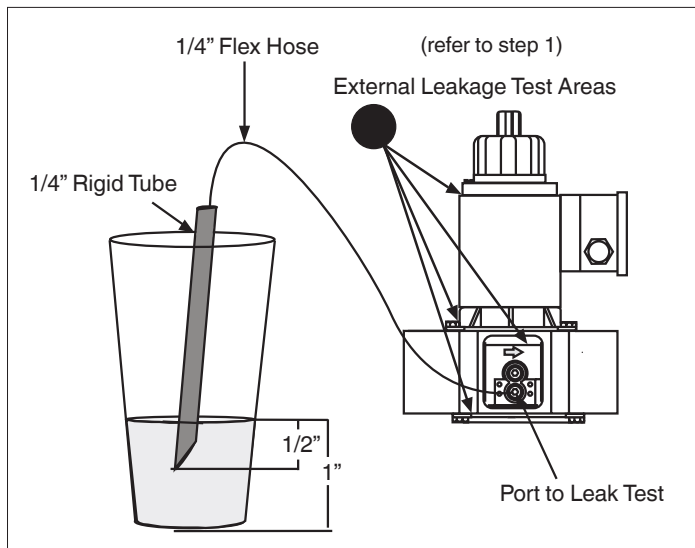

Leak Test Procedure

Use the illustration below as a reference.

1. With the upstream ball valve open, the downstream ball valve closed and both valves energized, apply an all purpose liquid leak detector solution to the "External Leakage Test Areas" indicated in the illustration below, to any accessories mounted to the safety valve, and to all gas piping and gas components downstream the equipment isolation valve, and the inlet and outlet gas piping for each automatic safety shutoff valve. The presence of bubbles indicates a leak, which needs to be rectified before proceeding.
2. Then, de-energize the burner system and verify that both automatic safety shutoff valves are closed.
3. Close the upstream and downstream manual ball valve.
4. Open the downstream test nipple of the upstream valve, and connect the 1/4" flexible hose to the test nipple.
5. Slowly open the upstream manual ball valve, and then provide for some time to allow potential leakage to charge the test chamber before measuring the valve seat leakage.
6. Immerse the 1/4 in. tube vertically 1/2 in. (12.7 mm) below the water surface. If bubbles emerge from the 1/4" tube and after the leakage rate has stabilized, count the number of bubbles appearing during a 10 second period. (See chart below for allowable leakage rates.)
7. Close the test nipple and repeat the procedure for the downstream automatic safety shutoff valve except that valve #1 needs to be opened during the leakage test.

After completing the above tests proceed as follows:

8. Verify that the downstream manual ball valve is closed, and both automatic safety shutoff valves are de-energized.
9. Remove the flexible hose, and close all test nipples.
10. With the upstream manual ball valve open, energize both automatic safety shutoff valves.
11. Use soapy water to leak test all test nipples to ensure that there are no leaks.
12. If no leakage is detected, de-energize all automatic safety shutoff valves, and open the downstream manual ball valve.

⚠ If leakage values are exceeded, replace valve immediately.

Type	Allowable Valve Seat Leakage* up to 7 PSI inlet	# of Bubbles in 10 s		
		Air	Natural Gas	LP
MVD, MV 505 & MVDLE 205	235 cc/hr	4	5	4
MVD, MV 507 & MVDLE 207	235 cc/hr	4	5	4
MVD, MV 510 & MVDLE 210	277 cc/hr	5	6	5
MVD, MV 512 & MVDLE 212	425 cc/hr	8	9	8
MVD 515 & MVDLE 215	425 cc/hr	8	9	8
MVD 520 & MVDLE 220	555 cc/hr	10	13	9
MVD 525 & MVDLE 225	620 cc/hr	11	14	10
MVD 530 & MVDLE 230	750 cc/hr	14	18	13

*Based on air and test conditions per UL 429 Section 29. (Air or inert gas at a pressure of 1/4 psig and also at a pressure of one and one-half times maximum operating pressure differential, but not less than 1/2 psig. This test shall be applied with the valve installed in its intended position.) Volume of bubble defined in Table 2 of FCI 70-2-1998.

Test Ports

Test Port

The 1/4 inch NPT taps are available on both sides upstream of the valve seat and downstream of the valve seat.

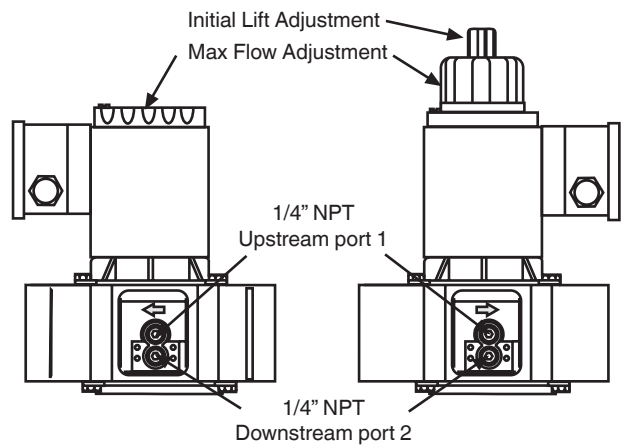
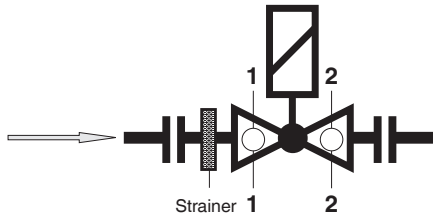

Flow Curve

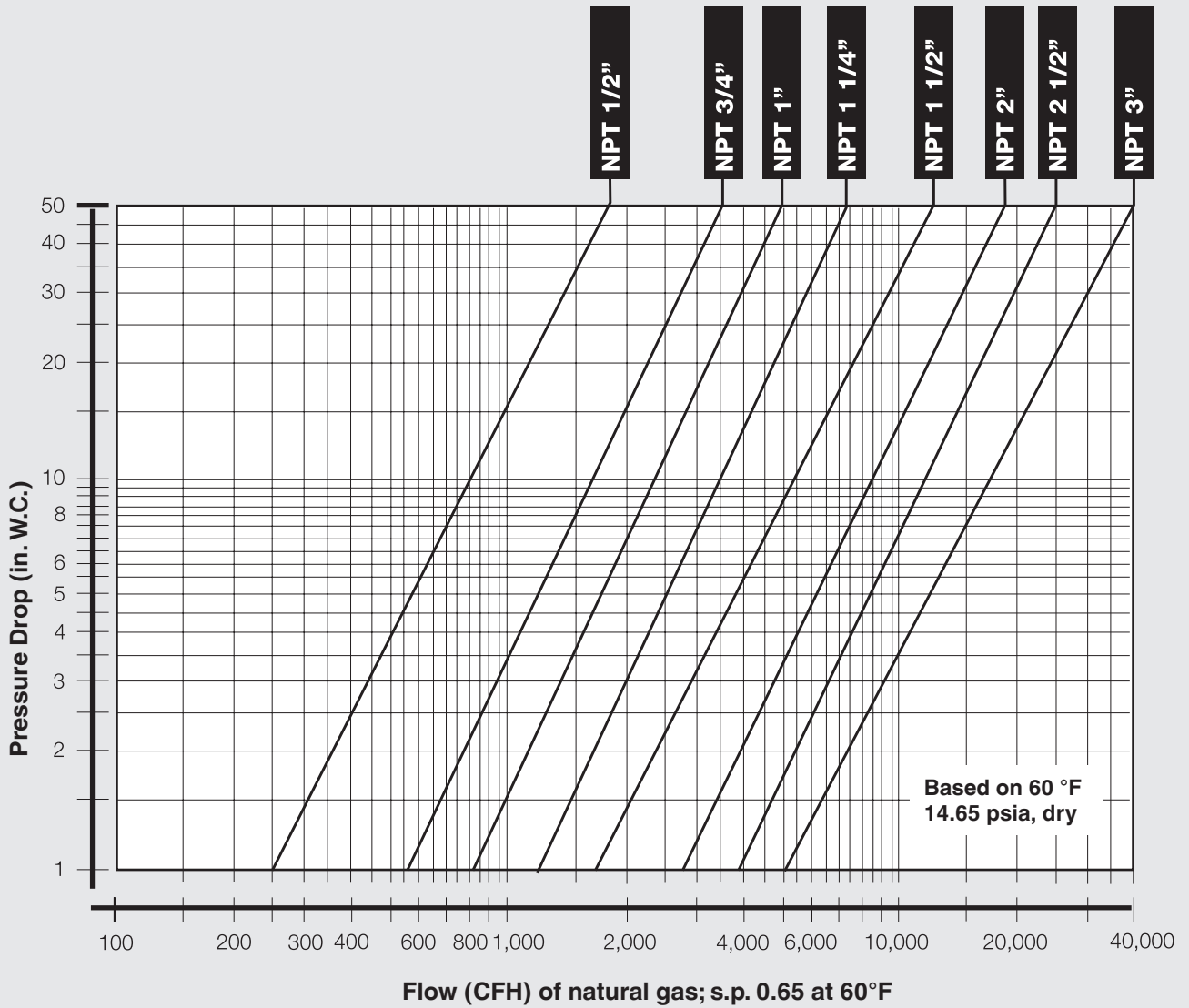

Pressure drop for other gases

To determine the pressure drop when using a gas other than natural gas, use the flow formula below and f value located in the table below to determine

the “corrected” flow rate in CFH through the valve for the other gas used. For example, when using propane, divide the volume (CFH) of propane required for the application by the calculated value

f (f = 0.66 for propane). Use this “corrected” flow rate and the flow curve on the next page to determine pressure drop for propane.

Determining equivalent flow through valves using another gas

$$\dot{V}_{\text{gas used}} = \dot{V}_{\text{Natural gas}} \times f$$

$$f = \frac{\text{Density of Natural gas}}{\text{Density of gas used}}$$

Type of gas	Density [kg/m ³]	s.g.	f
Natural gas	0.81	0.65	1.00
Butane	2.39	1.95	0.58
Propane	1.86	1.50	0.66
Air	1.24	1.00	0.80

Accessories & Replacement

Type	Mag Type #	Coil P/N for 120 VAC	Coil P/N for 24 VAC	PCB for 120 VAC
MVD 505 & MVDLE 205	100 (ID# 216 963 for 120 VAC and 217 390 for 24 VAC)	230-983	240-310	252-332A
MVD 507, MVD 510 & MVDLE 207 & MVDLE 210	200 (ID# 216 965 for 120 VAC and 217 391 for 24 VAC)	230-986	240-311	252-333A
MVD 512, MVD 515, MVDLE 212, MVDLE 215 & MVDLE 220	300 (ID# 216 967)	230-989	Not available	252-334A
MVD 520 & MVDLE 225	400 (ID# 216 968)	230-991	Not available	252-335A
MVD 525 & MVDLE 230	500 (ID# 216 969)	230-992	Not available	252-335A
MVD 530	550 (ID# 216 970)	230-993	Not available	252-335A

Valve Designation	P/N for Hydraulic Brake	P/N for replacement side tap
MVDLE 205/602	223-159	225 132
MVDLE 207/602	223-158	225 132
MVDLE 210/602	223-158	225 132
MVDLE 212/602	223-158	225 132
MVDLE 215/602	223-158	225 132
MVDLE 220/602	223-158	225 132
MVDLE 225/602	223-157	Not available
MVDLE 230/602	223-157	Not available

Valve Designation	P/N for Adjustment Knob	P/N for replacement side tap
MVD, MV 505/602	231-789	225 132
MVD, MV 507/602	231-790	225 132
MVD, MV 510/602	231-790	225 132
MVD, MV 512/602	231-790	225 132
MVD, MV 515/602	231-790	225 132
MVD, MV 520/602	231-790	225 132
MVD, MV 525/602	231-791	Not available
MVD, MV 530/602	231-791	Not available

Valve Designation	P/N for Cover Junction Box
All MVD valves	252-336

Valve Accessories

Description	P/N
CPI 400 Valve Switch	224-253A
Visual Indicator	217-665



Karl Dungs Inc.
 3890 Pheasant Ridge Drive NE
 Suite 150
 Blaine, MN 55449, U.S.A.
 Phone 763 582-1700
 Fax 763 582-1799
 e-mail info@karldungsusa.com
 Internet <http://www.dungs.com/usa/>

Karl Dungs GmbH & Co. KG
 P.O. Box 12 29
 D-73602 Schorndorf, Germany
 Phone +49 (0)7181-804-0
 Fax +49 (0)7181-804-166
 e-mail info@dungs.com
 Internet <http://www.dungs.com>



Replacement safety relevant components Austausch sicherheitsrelevanter Komponenten

DUNGS[®]
Combustion Controls



It is necessary to replace safety-relevant components after they have reached the end of their useful life.

DUNGS recommends replacing such components according to the following table:

Es besteht die Notwendigkeit sicherheitsrelevante Komponenten nach Erreichen ihrer Nutzungsdauer auszutauschen.

DUNGS empfiehlt den Austausch gemäß folgender Tabelle:

Valid only for domestic, residential and industrial* heating applications.			
*Not valid for high performance industrial heat process applications. See page 2			
Gültig nur für häusliche Heizungsanlagen			
Nicht gültig für Thermprozessanwendungen mit Taktbetrieb			
Valve Type Safety relevant component	Recommended replacement after years/cycles: → Depends on the value which will be achieved first		Max. Cycle Rate
	Empfohlener Austausch nach Jahren/Schaltspielen: → Je nachdem welcher Wert zuerst erreicht wird		
Ventil Typ Sicherheitsrelevante Komponente	USEFUL LIFE [Years] DUNGS recommends replacement after:	USEFUL LIFE [Rated Cycle Life (cycles)] DUNGS recommends replacement after:	Max. Schalthäufigkeit
	NUTZUNGSDAUER [Jahre] DUNGS empfiehlt den Austausch nach:	NUTZUNGSDAUER [Schaltspiele (auf/zu)] DUNGS empfiehlt den Austausch nach:	
DMV-(D)	10 Years 10 Jahre	1,000,000 cycles	500 /h
SV-(D)			
MV(D)/602			
DMV/MV/SV: LE-Ausführungen (mit Hydraulikbremse)	10 Years 10 Jahre	500,000 cycles	20 /h
DMV/MV/SV: LE-Versions (with hydraulic brake)			
Gasventil mit DUNGS-Ventilprüfsystem Gas valve with DUNGS valve proving system	Austausch nach erkanntem Fehler Replacement after error detection		
VPS 504*	10 Years 10 Jahre	250,000 cycles	20 /h
VDK 200*			15 /h
CPI 400		1,000,000 cycles @ 1 A and 120 VAC 100,000 cycles @ 10 A and 120 VAC	1,000 /h
CPI 401			

* Valve proving system values shown are expected lifetime. NFPA 86 does not require replacing if the expected life has been exceeded.

Änderungen, die dem technischen Fortschritt dienen, vorbehalten

We reserve the right to make modifications in the course of technical development.

Karl Dungs Inc.
3890 Pheasant Ridge Drive NE
Suite 150
Blaine, MN 55449, U.S.A.
Phone 763 582-1700
Fax 763 582-1799
e-mail info@karldungsusa.com
Internet <http://www.dungs.com/usa/>

Karl Dungs GmbH & Co. KG
P.O. Box 12 29
D-73602 Schorndorf, Germany
Phone +49 (0)7181-804-0
Fax +49 (0)7181-804-166
e-mail info@dungs.com
Internet <http://www.dungs.com>



It is necessary to replace safety-relevant components after they have reached the end of their useful life.

DUNGS recommends replacing such components according to the following table:

Es besteht die Notwendigkeit sicherheitsrelevante Komponenten nach Erreichen ihrer Nutzungsdauer auszutauschen.

DUNGS empfiehlt den Austausch gemäß folgender Tabelle:

Valid for high performance industrial heat process applications!			
Valve Type Safety relevant component Ventil Typ Sicherheitsrelevante Komponente	Recommended replacement after years/cycles: → Depends on the value which will be achieved first		Max. Cycle Rate
	Empfohlener Austausch nach Jahren/Schaltspielen: → Je nachdem welcher Wert zuerst erreicht wird		
	USEFUL LIFE [Years] DUNGS recommends replacement after:	USEFUL LIFE [Rated Cycle Life (cycles)] DUNGS recommends replacement after:	Max. Schalthäufigkeit
	NUTZUNGSDAUER [Jahre] DUNGS empfiehlt den Austausch nach:	NUTZUNGSDAUER [Schaltspiele (auf/zu)] DUNGS empfiehlt den Austausch nach:	
MV ... /602 NPT ½ - NPT 2 (no main flow adjustment)	3 Years 3 Jahre	3,000,000 cycles	1,000 /h
MVD ... /602 NPT ½ - NPT 1 (with main flow adjustment)			
MVD ... /602 NPT 1¼ - NPT 3 (with main flow adjustment)		1,000,000 cycles	
Conditions	Clean gas (NG, LNG, LPG): maximum 50 micron gas filter required!		
	Dry Gas: ■ relative humidity < 60 % ■ dew point of the gas < -14 °F		} "dry"
→ Not valid for MV(D).../602 valves delivered before 2011/01			

Änderungen, die dem technischen Fortschritt dienen, vorbehalten
We reserve the right to make modifications in the course of technical development.

Karl Dungs Inc.
3890 Pheasant Ridge Drive NE
Suite 150
Blaine, MN 55449, U.S.A.
Phone 763 582-1700
Fax 763 582-1799
e-mail info@karldungsusa.com
Internet <http://www.dungs.com/usa/>

Karl Dungs GmbH & Co. KG
P.O. Box 12 29
D-73602 Schorndorf, Germany
Phone +49 (0)7181-804-0
Fax +49 (0)7181-804-166
e-mail info@dungs.com
Internet <http://www.dungs.com>