

DR4300

Circular Chart Recorder

Product Manual

44-01-25-14

1/06

Revision K

Copyright, Notices, and Trademark

Printed in U.S.A. – © Copyright 2006 by Honeywell

Revision K– January 2006

WARRANTY/REMEDY

Honeywell warrants goods of its manufacture as being free of defective materials and faulty workmanship. Contact your local sales office for warranty information. If warranted goods are returned to Honeywell during the period of coverage, Honeywell will repair or replace without charge those items it finds defective. The foregoing is Buyer's sole remedy and is in lieu of all other warranties, expressed or implied, including those of merchantability and fitness for a particular purpose. Specifications may change without notice. The information we supply is believed to be accurate and reliable as of this printing. However, we assume no responsibility for its use.

While we provide application assistance personally, through our literature and the Honeywell web site, it is up to the customer to determine the suitability of the product in the application.

Industrial Measurement and Control
Honeywell
1100 Virginia Drive
Fort Washington, PA 19034

DR4300 and Accutune II are U.S. trademarks of Honeywell







Information Mapping is a trademark of Information Mapping Inc.

Modbus is a trademark of Modicon, Inc.

Other brands or product names are trademarks of their respective owners.

Symbol Definitions

The following table lists those symbols used in this document to denote certain conditions.

Symbol	Definition
	This CAUTION symbol on the equipment refers the user to the Product Manual for additional information. This symbol appears next to required information in the manual.
	WARNING PERSONAL INJURY: Risk of electrical shock. This symbol warns the user of a potential shock hazard where HAZARDOUS LIVE voltages greater than 30 Vrms, 42.4 Vpeak, or 60 Vdc may be accessible. Failure to comply with these instructions could result in death or serious injury.
	ATTENTION, Electrostatic Discharge (ESD) hazards. Observe precautions for handling electrostatic sensitive devices
	Protective Earth (PE) terminal. Provided for connection of the protective earth (green or green/yellow) supply system conductor.
	Functional earth terminal. Used for non-safety purposes such as noise immunity improvement. NOTE: This connection shall be bonded to protective earth at the source of supply in accordance with national local electrical code requirements.
	Earth Ground. Functional earth connection. NOTE: This connection shall be bonded to Protective earth at the source of supply in accordance with national and local electrical code requirements.
	Chassis Ground. Identifies a connection to the chassis or frame of the equipment shall be bonded to Protective Earth at the source of supply in accordance with national and local electrical code requirements.

Contents

1. OVERVIEW	1
1.1 Introduction	1
1.2 Model Number Breakdown	4
1.3 About This Manual	10
2. INSTALLATION	11
2.1 Overview	11
2.2 Mounting Considerations and Overall Dimensions.....	15
2.3 Mounting Methods	16
2.3.1 Introduction	16
2.3.2 Mounting Flush in Panel (New Panel Cutout).....	17
2.3.3 Panel Mounting Recorder with NEMA4 or Heavy Duty door	18
2.3.4 Mounting on a 2-inch pipe	20
2.3.5 Mounting on Surface (of Panel or Wall)	21
2.4 Wiring Prerequisites	22
2.5 Input Wiring	27
2.5.1 Power Wiring.....	27
2.5.2 Analog Input Wiring.....	31
2.5.3 Digital Inputs (Optional)	33
2.5.4 Communication (Optional).....	35
2.6 Output Wiring.....	37
2.6.1 Discrete Outputs	37
2.6.2 Current Output.....	41
2.6.3 Transmitter Power Out	43
3. CONFIGURATION, STARTUP, AND OPERATION OF BASIC RECORDER WITHOUT DISPLAY	45
3.1 Overview	45
3.2 Configuration (Recording Set Up).....	46
3.2.1 Setting Configuration and Input Switches.....	46
3.2.2 Setting SW6 Switch 2.....	64
3.3 Startup and Operation of Recorder without Display	65
3.3.1 Overview	65
3.3.2 Preparing the Recorder for Operation.....	66
3.3.3 Running the Optional Step Test.....	67
3.3.4 Startup.....	70
4. CONFIGURATION, STARTUP AND OPERATION OF RECORDER WITH DISPLAY	71
4.1 Overview	71

4.2	Operator Interface on Recorder with Display and Keypad.....	72
4.3	Configuration (Recording and Output Set Up).....	75
4.3.1	Overview	75
4.3.2	Configuration Prompts	76
4.3.3	How to Get Started	78
4.3.4	Configuration Tips.....	79
4.3.5	Switch Settings	80
4.3.6	Configuration Procedure.....	85
4.3.7	Input Parameters Set Up Group.....	87
4.3.8	Pen Parameters Set Up Group	91
4.3.9	Chart Parameters Set Up Group	92
4.3.10	Totalizer Parameters Set Up Group.....	93
4.3.11	Control Parameters Set Up Group	96
4.3.12	Tuning Parameters Set Up Group.....	102
4.3.13	Setpoint Ramp/Program Set Up Group	106
4.3.14	Timer Set Up Group	107
4.3.15	Alarms Set Up Group	107
4.3.16	Auxiliary Output Set Up Group.....	110
4.3.17	Communication Set Up Group	112
4.3.18	Remote Switch (Digital Inputs) Set Up Group.....	113
4.3.19	Display Parameter Set Up Group	115
4.3.20	Lock Out Parameter Set Up Group.....	116
4.3.21	Configuration Record Sheet	117
4.3.22	Limit Control Configuration.....	118
4.4	Startup of Recorder with Display and Keypad.....	119
4.4.1	Overview	119
4.4.2	Preparing the Recorder for Startup.....	120
4.4.3	Running the Optional Step Test.....	121
4.4.4	Completing Preparation and Startup.....	123
4.5	Operation of Recorder with Display and Keypad.....	128
4.5.1	Monitoring Your Recorder	128
4.5.2	Operator Functions	132
5.	INPUT AND OUTPUT CALIBRATION FOR RECORDER WITH DISPLAY	141
5.1	Overview	141
5.2	Input Calibration Minimum and Maximum Range Values	142
5.3	Input Calibration Preliminary Information	144
5.4	Input Calibration Set Up and Wiring.....	146
5.4.1	General Calibration Set Up.....	146
5.4.2	Thermocouple Inputs Using a Compensated Calibrator.....	147
5.4.3	Thermocouple Inputs Using an Ice Bath or Ice Point Reference.....	148
5.4.4	RTD (Resistance Temperature Detector) Inputs	149
5.5	Input Calibration Procedure.....	151
5.6	Current Output Calibration	153
6.	ROUTINE MAINTENANCE	157

6.1	Overview	157
6.2	Replacing the Chart	158
6.3	Replacing the Ink Cartridge.....	159
6.4	Maximizing Pen Life	160
7.	TROUBLESHOOTING AND PEN ALIGNMENT OF BASIC RECORDER WITHOUT DISPLAY	161
7.1	Overview	161
7.2	Observable Symptoms of Failure	163
7.3	Troubleshooting Procedures	164
7.3.1	Overview	164
7.3.2	Recorder Failure Troubleshooting.....	165
7.3.3	Pen Trace Troubleshooting.....	166
7.3.4	Chart Rotation Troubleshooting	167
7.3.5	Troubleshooting Erratic Pen Movement.....	168
7.4	Alignment of Pen at Zero and 100 %	169
8.	TROUBLESHOOTING AND PEN ALIGNMENT OF RECORDER WITH DISPLAY	171
8.1	Overview	171
8.2	Troubleshooting Aids	173
8.3	Self Diagnostics.....	174
8.3.1	Power up tests	174
8.3.2	View Status of Tests	175
8.3.3	Background Tests	176
8.3.4	Error Messages	176
8.4	Observable Symptoms of Failure	179
8.5	Troubleshooting Procedures	180
8.5.1	Overview	180
8.5.2	Recorder Failure Troubleshooting.....	181
8.5.3	Pen Trace Troubleshooting.....	182
8.5.4	Chart Rotation Troubleshooting	183
8.5.5	Troubleshooting Erratic Pen Movement.....	184
8.5.6	Troubleshooting the Keypad and Display	184
8.5.7	Troubleshooting Relay Output	185
8.5.8	Troubleshooting External Alarm Function.....	186
8.5.9	Troubleshooting Remote Switch (Digital Input) Function.....	186
8.5.10	Troubleshooting Modbus Communications	187
8.6	Alignment of Pen at Zero and Span.....	188
9.	PARTS LIST.....	191
9.1	Overview	191
9.2	Exploded Views.....	192

A. ACCURACY	199
A.1 Overview	199
A.2 Typical Reference Accuracy.....	200
B. AVAILABLE 10-INCH CHARTS	203
B.1 Single Range Charts	203
B.2 Dual Range Charts.....	208
C. SETPOINT RAMP/SOAK PROGRAMMING AND OPERATION.....	211
C.1 Overview	211
C.2 Program Contents.....	212
C.3 Drawing a Ramp/Soak Profile	214
C.4 Setpoint Program Prompt Hierarchy	218
C.5 Run/Monitor the Program.....	221
D. USING ACCUTUNE II	225
D.1 Overview	225
D.2 Starting and Stopping Tuning with Accutune II.....	226
D.3 Using Accutune with Duplex (Heat/Cool) Control	227
E. FOREIGN LANGUAGE SAFETY INSTRUCTIONS.....	229
F. HONEYWELL SERVICE CENTERS.....	241

Tables

Table 2-1	Operating Limits and Condensed Specifications	12
Table 2-2	Mounting Flush in a New Panel Cutout	17
Table 2-3	Procedure for Mounting Recorder with NEMA4 or Heavy Duty Door	18
Table 2-4	Pipe Mounting Procedure	20
Table 2-5	Mounting Flush on a Surface (of Panel or Wall)	21
Table 2-6	Wiring Bundling Categories	26
Table 2-7	Wiring Illustrations	26
Table 2-8	Procedure for Power Wiring Models	28
Table 2-9	Analog Input Wiring	31
Table 2-10	Digital Input Wiring	33
Table 2-11	Communication Wiring	35
Table 2-12	Output Terminal Use for Output Algorithm and Option Combinations	37
Table 2-13	Relay Output Wiring - 1 or 2 Pen Models	38
Table 2-14	Current Output Wiring	41
Table 2-15	Transmitter Power Out Wiring	43
Table 3-1	Procedure for Configuring Model without Display	46
Table 3-2	Configuration and Input Switch Settings for Models without Display	49
Table 3-3	Preparing the Recorder for Operation	66
Table 3-4	Procedure for Running the Step Test	67
Table 3-5	Startup Procedure	69
Table 4-1	Key Functions	73
Table 4-2	Configuration Tips	78
Table 4-3	SW6 Input Switch Settings for Models Having Display and Keypad	80
Table 4-4	Configuration Procedure	83
Table 4-5	Input Parameter Definitions	85
Table 4-6	Pen Parameter Definitions	89
Table 4-7	Chart Parameter Definitions	90
Table 4-8	Totalizer Function Definitions	91
Table 4-9	Control Parameter Definitions	94
Table 4-10	Tuning Parameter Definitions	101
Table 4-11	Setpoint Ramp Parameter Definitions	104
Table 4-12	Timer Parameter Definitions	105
Table 4-13	Alarm Parameter Definitions	106
Table 4-14	Auxiliary Output Parameter Definitions	109
Table 4-15	Communication Parameter Definitions	111
Table 4-16	Remote Switch Parameter Definitions	113
Table 4-17	Display Parameter Definitions	114
Table 4-18	Lockout Parameter Definitions	115
Table 4-19	Limit Control Parameter Definitions	118
Table 4-20	Preparing the Recorder for Operation	120
Table 4-21	Procedure for Running the Step Test	121
Table 4-22	Procedure for Setting Chart Time and Applying Power	123
Table 4-23	Power-Up Diagnostic Tests	124
Table 4-24	Procedure for Testing the Displays and Keys	125
Table 4-25	Procedure for Starting the Recorder	126
Table 4-26	Meaning of Indicators	129
Table 4-27	Lower Display Operating Parameter Labels	130
Table 4-28	Error Messages	131
Table 4-29	Procedure for Selecting Automatic or Manual Mode	133
Table 4-30	Procedure for Changing the Control Setpoints	134
Table 4-31	Procedure for Displaying or Changing the Alarm Setpoints	135
Table 4-32	Procedure for Selecting Factory or Field Calibration Values	136

Table 4-33 Procedure for Resetting Totalizer	137
Table 4-34 Procedure for Starting Timer	138
Table 4-35 Procedure for Resetting Limit Controller.....	139
Table 5-1 Voltage and Resistance Equivalents for 0 % and 100 % Range Values	143
Table 5-2 Equipment Needed for Calibration	144
Table 5-3 Disconnect the Field Wiring	145
Table 5-4 General Calibration Set Up Procedure	146
Table 5-5 Set Up Wiring Procedure for Thermocouple Inputs Using a Compensated Calibrator	147
Table 5-6 Set Up Wiring Procedure for Thermocouple Inputs Using an Ice Bath.....	148
Table 5-7 Set Up Wiring Procedure for Calibrating RTD Inputs.....	149
Table 5-8 Set Up Wiring Procedure for Calibrating Millivolts, Volts, and Milliamps Inputs	150
Table 5-9 Input Calibration Procedure Sequence.....	151
Table 5-10 Set Up Wiring Procedure for Current Proportional Output	153
Table 5-11 Procedure for Calibrating Current Output.....	154
Table 6-1 Procedure for Replacing the Chart.....	158
Table 6-2 Procedure for Replacing the Ink Cartridge	159
Table 6-3 Maximizing Pen Life.....	160
Table 7-1 Observable Symptoms of Failure.....	163
Table 7-2 Troubleshooting Recorder Failure Symptoms	165
Table 7-3 Troubleshooting Pen Trace Failure Symptoms	166
Table 7-4 Troubleshooting Chart Rotation Failure Symptoms	167
Table 7-5 Troubleshooting Erratic Pen Movement Symptoms	168
Table 7-6 Procedure for Pen Alignment.....	169
Table 8-1 Procedure for Identifying the Software Version	173
Table 8-2 Power-Up Diagnostic Tests.....	174
Table 8-3 Procedure for Displaying the Results of Self-Diagnostics.....	175
Table 8-4 Error Messages.....	177
Table 8-5 Observable Symptoms of Failure.....	179
Table 8-6 Troubleshooting Recorder Failure Symptoms	181
Table 8-7 Troubleshooting Pen Trace Failure Symptoms	182
Table 8-8 Troubleshooting Chart Rotation Failure Symptoms	183
Table 8-9 Troubleshooting Erratic Pen Movement Symptoms	184
Table 8-10 Troubleshooting Keypad and/or Display Failure Symptoms	184
Table 8-11 Troubleshooting Relay Output Failure Symptoms.....	185
Table 8-12 Troubleshooting External Alarm Function Failure Symptoms	186
Table 8-13 Troubleshooting Remote Switch (Digital Input) Function Failure Symptoms	186
Table 8-14 Troubleshooting Modbus Communications	187
Table 8-15 Procedure for Aligning Pen at Zero and Span	188
Table 9-1 Door Assembly Parts.....	192
Table 9-2 Chart Plate Assembly Parts	193
Table 9-3 Basic Recorder Parts	195
Table A-1 Typical Reference Accuracy	200
Table B-1 10-inch Single Range Chart Part Numbers.....	203
Table B-2 10-inch Dual Range Chart Part Numbers	208
Table C-1 Prompt Hierarchy and Available Selections.....	218
Table C-2 Run/Monitor Functions	221
Table D-1 Procedure for Starting Accutune II	226
Table D-2 Procedure for Using Accutune for Duplex Control	227

Figures

Figure 1-1 Guide to Manual's Organization.....	10
Figure 2-1 Overall Dimensions	15
Figure 2-2 Plug Locations	16
Figure 2-3 Mounting Flush in a New Panel Cutout (Rear View).....	17
Figure 2-4 Panel Mounting Recorder with NEMA4 or Heavy Duty Door	19
Figure 2-5 Pipe Mounting Brackets.....	20
Figure 2-6 Mounting Flush on a Surface of Panel or Wall (Rear View).....	22
Figure 2-7 Recommended Wiring Routing - Models Without CE Mark	24
Figure 2-8 Recommended Wiring Routing - Models With CE Mark	25
Figure 2-9 Power Wiring – Models Without CE Mark.....	29
Figure 2-10 Power Wiring – Models With CE Mark	30
Figure 2-11 Analog Input Wiring.....	32
Figure 2-12 Digital Input Wiring	34
Figure 2-13 Communication Wiring	36
Figure 2-14 Relay Output Wiring.....	39
Figure 2-15 Open Collector Output Wiring	40
Figure 2-16 Current Output Wiring.....	42
Figure 2-17 Transmitter Power Out Wiring	44
Figure 3-1 Location of Configuration and Input Switches.....	47
Figure 3-2 Sample Chart for Single Pen Recorder	48
Figure 3-3 Basic Chart Plate Components.....	66
Figure 3-4 Typical Step Test Chart Patterns.....	68
Figure 3-5 Setting Chart Time to Time Index	69
Figure 4-1 Operator Interface.....	72
Figure 4-2 Prompt Hierarchy.....	75
Figure 4-3 Location of Switches and Relays.....	82
Figure 4-4 Basic Chart Plate Components.....	120
Figure 4-5 Typical Step Test Chart Patterns.....	122
Figure 4-6 Setting Chart Time to Time Index	123
Figure 4-7 Operator Interface.....	128
Figure 5-1 Location of the Input Connections on the Input Boards.....	145
Figure 5-2 Calibration Set Up Diagram for Thermocouple Inputs Using a Compensated Calibrator.....	147
Figure 5-3 Calibration Set Up Diagram for Thermocouple Inputs Using an Ice Bath	148
Figure 5-4 Calibration Set Up Diagram for RTD Inputs.....	149
Figure 5-5 Calibration Set Up Diagram for Millivolts, Volts, and Milliamps Inputs.....	150
Figure 5-6 Test Equipment Connections for Calibrating Current Output	153
Figure 6-1 Replacing the Chart and Ink Cartridge	158
Figure 9-1 Door Assembly	192
Figure 9-2 Chart Plate Assembly.....	193
Figure 9-3 Recorder Components.....	194
Figure 9-4 DR4300 Recorder (CE Mark) – Internal Cabling Diagram.....	196
Figure 9-5 DR4300 Recorder (Non-CE Mark) – Internal Cabling Diagram.....	197
Figure C-1 Ramp/Soak Profile Example	214

1. Overview

1.1 Introduction

Function

The DR4300 recorder is a one or two pen microprocessor-based circular chart recorder. The basic DR4301 (one pen) and DR4302 (two pen) recorders provide reliable, convenient pen-drawn analog traces on preprinted 10 inch (250 mm) charts. Both the chart and the pens are driven by stepper motors controlled by the microprocessor. Chart speed and range are configurable. The basic recorder is also available in CE models DR4321 (one pen) and DR4322 (two pen).

In addition to generating pen-drawn chart traces, the DR4311 (one pen) and DR4312 (two pen) models include a display and keypad. This option lets you display the real time value of the process variable for each pen channel, as well as other values. The recorder with display and keypad is also available in CE models DR4331 (one pen) and DR4332 (two pen).

Each pen channel has its own printed circuit assembly (PCA), allowing the channels to operate independently.

CE conformity (Europe)

Indicated models of this product are in conformity with the protection requirements of the following European Council Directives: **73/23/EEC**, the Low Voltage Directive, and **89/336/EEC**, the EMC Directive. Conformity of this product with any other “CE Mark” Directive(s) shall not be assumed.

Deviation from the installation conditions specified in this manual, and the special conditions for CE conformity in Section 2 of this manual, may invalidate this product’s conformity with the Low Voltage and EMC Directives.

Analog inputs

The input for each pen channel can be one of any standard electrical signal: milliamp, millivolt, voltage, RTD, or thermocouple. The input type and range are configurable. In the models having display and keypad the range can be expanded and compressed to meet specific measurement needs. The display and keypad also permit entry of input bias and filter values. (The input filter for the models without a display is fixed at one second; their bias is zero.)

Digital inputs

Two digital inputs for each pen channel are available as an option. These inputs can be used to trigger the switchover to a second control setpoint or a pre-configured constant output if an external event causes contact closure (sets the digital input to ON). In addition, the digital inputs can be used to remotely reset the optional totalizer or limit controller.

Communications

The Modbus communication option permits configuration of the unit and monitoring of process variables over a standard multi-drop serial communications link.

Relay outputs for control and alarms

The models with display and keypad are available with output relays, two for each pen channel. These relays can be wired for Normally Open (NO) and Normally Closed (NC) terminals. ON-OFF control can be performed using one relay (relay simplex control) or two relays (relay duplex control).

Any relay not used for control is available for alarming. Two alarm setpoints can be configured for each alarm relay. An adjustable hysteresis of 0.0 % to 100.0 % is configurable for the alarm setpoint.

Analog output for control or retransmission

Depending on the model ordered, a 4 to 20 mA current output may be available for control or retransmission of a process variable (“auxiliary output”).

Failsafe operation

The control function can operate in automatic or manual mode. In automatic the control function works to maintain the process variable at the setpoint entered locally by the operator. During configuration a “failsafe” value can be specified. This value is used as the output at power up and in case of input failure during automatic operation. (When the unit goes to failsafe, the control function goes to manual mode.)

In manual mode the operator enters the output locally. If the recorder has gone to failsafe operation, the operator will be able to change the output value from the failsafe value specified during configuration.

Timer and totalizer options

The recorder is available with timer and totalizer options. The timer can be started locally, remotely, or by an alarm. The unit can be configured to display elapsed time or time remaining. At the end of the timeout period Relay 2 is energized, and remains energized until the timer is reset. The totalizer can be reset locally or remotely; its displayed value can be scaled.

Setpoint Programming Option

The recorder is available with a Setpoint Program option. This feature allows configuration of up to four setpoint programs using a total of twenty-four ramp and soak segments. A setpoint and time is configured for each segment. The program can be set up to include guaranteed soak segments. A plus/minus deviation is configured for all soak segments. Whenever the plus/minus deviation is exceeded, soak timing is frozen.

Display and keypad

In addition to process variables, the display can show output, setpoint, and deviation real time values if the recorder is equipped with optional outputs. The upper display uses four characters to display the input value. The lower display shows other parameters using a two- or three-character label and four- or three-digit values. In addition, status and error messages flash on the lower display when necessary.

The six keys are used to select the real time value to be displayed, and to select set up parameters and their values during configuration. The display and keypad are behind the door, protecting them from dirt. A supplementary external keypad is also available.

For more information about the operator interface on models having a display and keypad, see Subsection 4.2.

Configuration

The models without a display are configured with two switchbanks: one for configuration, the other for input definition. Configuration is a simple matter of consulting a table in this manual; selecting the appropriate combination of range, chart speed, engineering unit, and input type; then setting the switches as shown in the table.

The display and keypad are used to configure models with these options. When the unit is in configuration mode, set up parameters are displayed, and grouped by function. Designate site-specific values by selecting them from a list of choices, or entering them as numeric values. The operator can be locked out from making configuration changes.

The models with display also use a switchbank to define the type of input to be expected by the hardware. Input parameters used by the software are configured using the display and keypad.

Self-diagnostics

All DR4300 recorders run self-diagnostics at power up and in the background during normal operation. Problems are reported by error messages on the display when present. An LED in the models without a display lights if the unit fails a self-diagnostic.

Construction

All DR4300 recorders are housed in a rugged molded case which can be panel-, pipe- or surface-mounted. An acrylic-windowed, gasketed door protects internal components from harsh environments while allowing easy access to the chart.

1.2 Model Number Breakdown

Introduction

The model number breakdown is presented in the tables that follow. Note that not all options are available with all recorders. Check the “Availability” column for each model. A star (★) in the Availability column means unrestricted availability of the feature for that model. N/A indicates the feature is not available for that model. A letter in the Availability column denotes restricted availability. The meaning of each letter is provided at the bottom of this page.

The Notes referred to in the tables are also at the end of this subsection.

Model number format

The basic model number consists of a key number. Appended to this key number are characters that identify the features in various categories. The meaning of the characters in each category is presented in a table identified below.

Key Number	Table I	Table II	Table III	Table IV	Table V	Table VI
DR43__	-	-----	-	-----	-	-----
						000

Key numbers

The base model numbers for the DR4300 Circular Chart Recorder are:

One Pen Recorder (Basic Recorder Without Display)	DR4301
Two Pen Recorder (Basic Recorder Without Display)	DR4302
One Pen Recorder (With Display)	DR4311
Two Pen Recorder (With Display)	DR4312
One Pen Recorder (Basic Recorder Without Display, With CE Mark)	DR4321
Two Pen Recorder (Basic Recorder Without Display, With CE Mark)	DR4322
One Pen Recorder (With Display, With CE Mark)	DR4331
Two Pen Recorder (With Display, With CE Mark)	DR4332

Restricted availability designations

d = Not available with Table I selection XX0X.

e = Not available with Table I selection XXX0.

f = Not available with Table I selection 0XXX.

g = Not available with Table I selection 0000.

h = Not available with Table I selections FXXX, XFXX, GXXX, XGXX.

j = Not available with Table I selection 0XXX.

k = Not available with Table I selection X0XX.

m = Not available with Table I selections 2XXX, 3XXX, 4XXX, 5XXX, AXXX, XXX0.

n = Not available with Table II selection SXXXX.

p = Not available with Table II selections RXXXX, SXXXX.

q = Not available with Table II selections GXXXX, BXXXX, HXXXX, CXXXX, KXXXX, LXXXX.

Model Number Table I - OUTPUT

Description	Model No.	Availability			
		4301 4321	4302 4322	4311 4331	4312 4332
Pen One					
None	0 _ _ _	★	★	★	★
2 Outputs (Alarm/On-Off Control)	2 _ _ _	N/A	N/A	d	d
1 PID Control with Accutune II <i>(see Note 1)</i>	3 _ _ _	N/A	N/A	d	d
1 PID Control/Setpoint Program/Timer <i>(see Note 1)</i>	4 _ _ _	N/A	N/A	d	d
2 Outputs (Alarm 1 and Timer)	5 _ _ _	N/A	N/A	d	d
4 to 20 mA Retransmission Output <i>(see Note 4)</i>	A _ _ _	N/A	N/A	d	d
FM Approved Limit Control	F _ _ _	N/A	N/A	d	d
FM Approved Limit Control/Timer Output	G _ _ _	N/A	N/A	d	d
Pen Two					
None	_ 0 _ _	★	★	★	★
2 Outputs (Alarm/On-Off Control)	_ 2 _ _	N/A	N/A	N/A	e
1 PID Control with Accutune II <i>(see Note 1)</i>	_ 3 _ _	N/A	N/A	N/A	e
1 PID Control/Setpoint Program/Timer <i>(see Note 1)</i>	_ 4 _ _	N/A	N/A	N/A	e
2 Outputs (Alarm 1 and Timer)	_ 5 _ _	N/A	N/A	N/A	e
4 to 20 mA Retransmission Output <i>(see Note 4)</i>	_ A _ _	N/A	N/A	N/A	e
FM Approved Limit Control	_ F _ _	N/A	N/A	N/A	m
FM Approved Limit Control/Timer Output	_ G _ _	N/A	N/A	N/A	m
Output Type Pen 1					
None	_ _ 0 _	★	★	★	★
Electromechanical Relay	_ _ E _	N/A	N/A	j	j
Solid State Relay	_ _ S _	N/A	N/A	j	j
Open Collector	_ _ T _	N/A	N/A	j	j
Output Type Pen 2					
None	_ _ _ 0	★	★	★	★
Electromechanical Relay	_ _ _ E	N/A	N/A	N/A	k
Solid State Relay	_ _ _ S	N/A	N/A	N/A	k
Open Collector	_ _ _ T	N/A	N/A	N/A	k

Model Number Table II - INSTRUMENT OPTIONS

Description	Model No.	Availability			
		4301 4321	4302 4322	4311 4331	4312 4332
Door Options					
Gray Door	G _ _ _ _	★	★	★	★
Blue Door	B _ _ _ _	★	★	★	★
Gray Door with External Keypad	H _ _ _ _	N/A	N/A	★	★
Blue Door with External Keypad	C _ _ _ _	N/A	N/A	★	★
Black Door	K _ _ _ _	★	★	★	★
Black Door with External Keypad	L _ _ _ _	N/A	N/A	★	★
SST Door	R _ _ _ _	★	★	★	★
NEMA 4 SST Door	S _ _ _ _	★	★	★	★
Standard Latch	_ 0 _ _ _	n	n	n	n
Keyed Latch	_ A _ _ _	★	★	★	★
Keyed Latch/Chart Plate Seal	_ B _ _ _	q	q	q	q
Door Lock	_ K _ _ _	p	p	p	p
Instrument Power/Transmitter Power					
Universal Recorder Power	_ _ 1 _ _	★	★	★	★
Universal Power +24 Vdc Transmitter Power	_ _ 3 _ _	★	★	★	★
Communications					
None	_ _ _ 0 _	★	★	★	★
RS485 Modbus RTU Communication (see Note 5)	_ _ _ C _	★	★	★	★
Product Configuration					
Standard	_ _ _ _ 0	★	★	★	★
Configuration for Non-Standard Range Settings (see Note 6)	_ _ _ _ 1	★	★	N/A	N/A
Configuration for Customer's Specific Data (see Note 6)	_ _ _ _ 2	N/A	N/A	★	★

Model Number Table III - PEN 1 OPTIONS

Description	Model No.	Availability			
		4301 4321	4302 4322	4311 4331	4312 4332
No Digital Inputs	0 _ _ _	★	★	★	★
Digital Inputs (See Note 3)	D _ _ _	N/A	N/A	f	g
None	_ 0 _ _	★	★	★	★
No Totalizer Function	_ _ 0 _	★	★	★	★
Totalizer	_ _ T _	N/A	N/A	h	h
<i>Future</i>	_ _ _ 0	★	★	★	★

Model Number Table IV - PEN 2 OPTIONS

Description	Model No.	Availability			
		4301 4321	4302 4322	4311 4331	4312 4332
No Digital Inputs	0 _ _ _	★	★	★	★
Digital Inputs (See Note 3)	D _ _ _	N/A	N/A	N/A	g
None	_ 0 _ _	★	★	★	★
No Totalizer Function	_ _ 0 _	★	★	★	★
Totalizer	_ _ T _	N/A	N/A	N/A	h
<i>Future</i>	_ _ _ 0	★	★	★	★

Model Number Table V - APPROVALS/CERTIFICATES

Description	Model No.	Availability			
		4301 4321	4302 4322	4311 4331	4312 4332
No Approvals	0 _	★	★	★	★
UL Listing	U _	n	n	n	n
CSA Certification	C _	n	n	n	n
UL and CSA Approved	B _	n	n	n	n
No Certificate	_ 0	★	★	★	★
Certificate of Conformance (F3391)	_ 1	★	★	★	★
Certificate of Calibration (F3399) (See Note 2)	_ 2	★	★	★	★
Certificate of Conformance and Calibration (See Note 2)	_ 3	★	★	★	★

NOTE 1: PID control options include current output plus two discrete outputs for alarms. If ON-OFF or time-proportioned simplex control is used, only one discrete output is available for an alarm. Time-proportioned duplex control requires the use of both outputs and therefore no relay outputs are available for alarms on that pen channel. Accutune II tuning is a standard feature with PID control options.

NOTE 2: Customer must supply the input actuation and range information for each input in the Free Form section of the order to have the unit supplied with a Certificate of Calibration.

NOTE 3: Digital Inputs are only available when ordering outputs in Table I.

NOTE 4: 4 to 20 mA Retransmission Output includes two outputs per pen for alarms. You must specify the type of alarm outputs required (i.e., Relay, SS Relay, Open Collector Outputs).

NOTE 5: On key numbers DR4301, DR4302, DR4321, and DR4322 the communication address is fixed; the display assembly is required to change it. Only one DR4301 or DR4321 instrument, or only one pen of a DR4302 or DR4322 can exist on the network, otherwise communication conflicts will exist. Pen 1 is the default when communications is specified on these models.

NOTE 6: Recorder is supplied with one box of 30755820-001, 0 to 100 Even "starter" charts. For special range configuration on the DR4301, DR4302, DR4321, or DR4322 Recorder, provide the Input Type, Chart Range, Chart Speed, °C or °F, Engineering Units, Linear or Non-Linear Chart Type when ordering.

For example: Pen 1: "J" Thermocouple, 0-375 °F, 7-Day Linear Chart
Pen 2: 4-20 mA, 0-1000, 7-Day Linear Chart

For configuration on Models DR4311, DR4312, DR4331, and DR4332, the customer must supply completed "Configuration Worksheets" with order for units to be Factory configured.

1.3 About This Manual

All models described

This manual contains instructions for installation, set up, startup, operation, troubleshooting, and repair of all recorder models listed in Subsection 1.2. The models fall into two broad categories:

- **basic version without display:** DR4301, DR4302, DR4321, and DR4322
- **enhanced version with display:** DR4311, DR4312, DR4331, and DR4332

Some sections in the manual apply to all models, while others contain information specific to one of these two categories. Unless a section's title refers to recorders "without display" or "with display", the information in the section applies to all models. To see which sections apply to your recorder, see Figure 1-1.

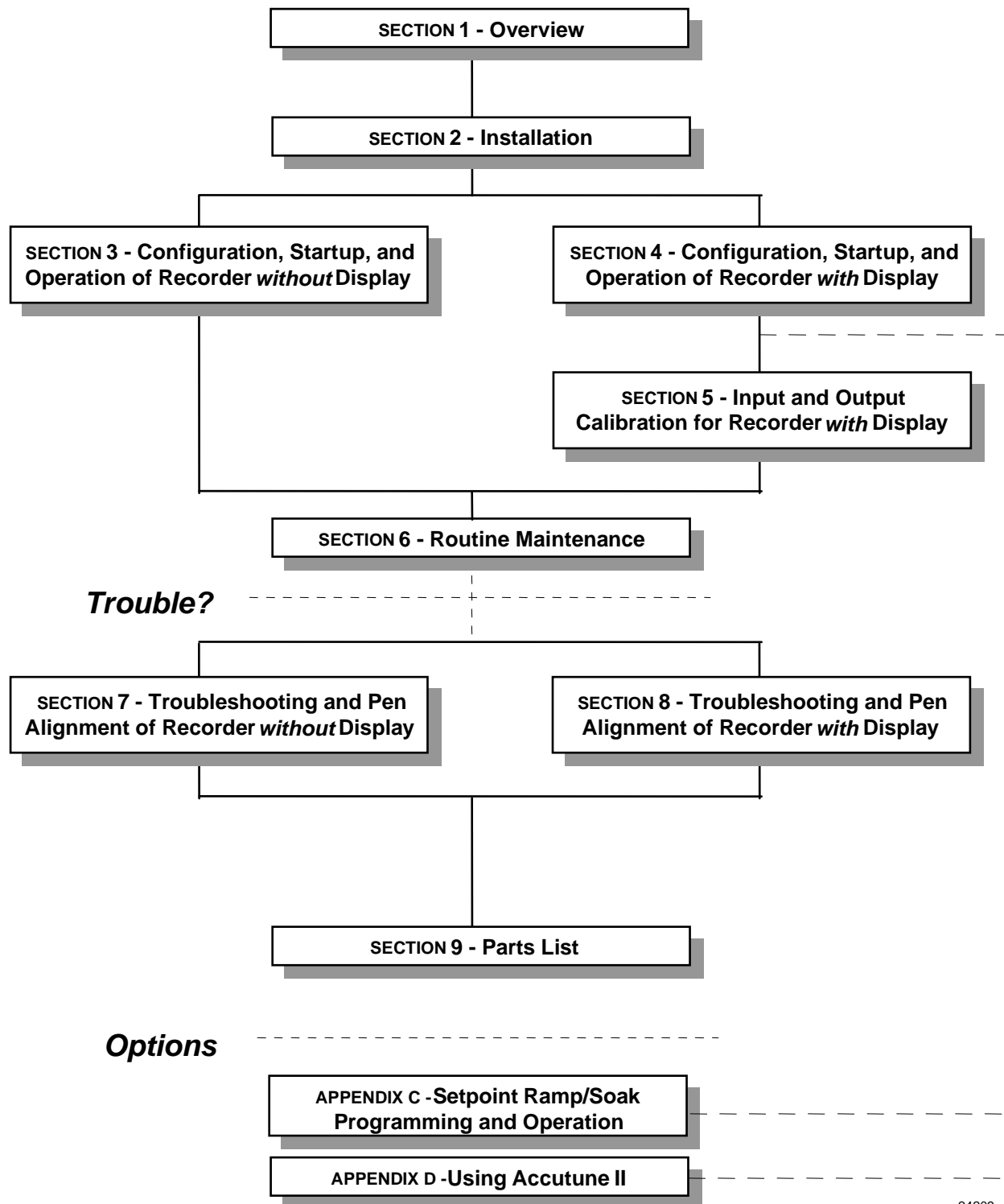

24209

Figure 1-1 Guide to Manual's Organization

2. Installation

2.1 Overview

Introduction

Installation of the DR4300 recorder consists of mounting and wiring the recorder according to the instructions given in this section.

Read the pre-installation information below, check the model number interpretation in Section 1, and become familiar with your model selections, then proceed with installation.

What's in this section?

The following is a list of topics in this section.

Topic	See Page
2.1 Overview	11
2.2 Mounting Considerations and Overall Dimensions	15
2.3 Mounting Methods	16
2.4 Wiring Prerequisites	22
2.5 Input Wiring	27
2.6 Output Wiring	37

Pre-installation information

If the recorder has not been removed from its shipping carton, inspect the carton for damage and remove the recorder. Inspect the unit for any obvious shipping damage and report any damage due to transit to the carrier.

- Make sure a bag containing mounting hardware is included in the carton with the recorder.
- Check that the model number shown on the chart plate agrees with what you have ordered.

Operating limits

We recommend that you review and adhere to the operating limits listed in Table 2-1 when you install your recorder.

Table 2-1 Operating Limits and Condensed Specifications

Condition	Specifications
Accuracy	See Appendix A
Ambient Temperature	0 °C to 55 °C [32 °F to 131 °F]
Relative Humidity	5 % to 90 % RH at 40 °C [104 °F]
Vibration Frequency Acceleration	0 to 200 Hz 0.5 g
Mechanical Shock Acceleration Duration	5 g 30 ms
Mounting Position from Vertical Tilted Forward Tilted Backward Tilted to side (±)	5° 90° 20°
Power Voltage (ac/dc) Frequency (Hz)	100 Vac to 240 Vac 60 ±1 or 50 ±1
Power Consumption	20 Watts maximum
Type of Actuators	<i>Thermocouple:</i> B, E, E (low), J, J (low), K, K (low), Ni-Ni Moly, Nicrosil-Nisil, R, S, T, T (low), W5W26 <i>RTD:</i> Platinum 100 ohms*, 100 ohms (low)*, 100 ohms** <i>Linear:</i> 4-20 mA dc, 0-20 mA dc, 0-10 mV dc, 0-100 mV dc, 0-200 mV dc, 0-1 Vdc, 0-2 Vdc, 0-5 Vdc, 0-10 Vdc, 1-5 Vdc, 2-10 Vdc <i>Digital:</i> +24 Vdc source for external dry contacts or isolated solid state contacts *IEC Alpha = 0.00385 **Alpha = 0.00391
Minimum Input Span	Range is fully configurable within span limitation of the sensing element.
Input Impedance	<i>mA dc:</i> 250 ohms <i>Vdc:</i> 200K ohms <i>RTD:</i> 13.3 K ohms <i>All others:</i> 10 Megohms
Span Step Response Time	7 seconds maximum
Reproducibility	0.1 percent of span
Sampling Rate	Input sampled 3 times per second

Condition	Specifications								
Input Filter	<p><i>Without Display:</i> Analog with time constant of 3 seconds and digital with time constant of 1 second.</p> <p><i>With Display:</i> Analog with time constant of 3 seconds and digital adjustable 0 seconds to 120 seconds.</p>								
Case	Molded, foamed-Noryl with gasketed door to meet NEMA 3 enclosure requirements.								
Pen	<p>Disposable fiber-tip ink cartridge, line length per cartridge more than 305 m [1000 ft]</p> <p><i>One Pen:</i> Purple <i>Two Pen:</i> Purple (pen 1) and red (pen 2)</p> <p>NOTE: Only pen 1 (purple) is referenced to the chart time line.</p>								
Chart	262 mm [10.32-inch] diameter chart with standard preprinted markings and a calibrated width of 100 mm [4 inches].								
Wiring Connections	Screw terminals (2 piece)								
Color	<p><i>Case:</i> Black <i>Door:</i> Standard—Gray; Optional—Caribbean blue or black</p>								
Weight	5.4 kg [12 lbs]								
Mounting	Panel-, pipe- or surface-mounted								
Installation Category (Overvoltage Category)	Category II: Energy-consuming Equipment Supplied from the Fixed Installation, Local Level Appliances, and Industrial Control Equipment (EN61010-1).								
Pollution Degree	Pollution Degree 2: Normally Non-conductive Pollution with Occasional Conductivity Caused by Condensation (Ref. IEC 664-1).								
EMC Classification	Group 1, Class A: ISM Equipment (EN55011, emissions), Industrial Equipment (EN50082-2, Immunity).								
Dielectric Insulation	<table border="0"> <tr> <td><i>AC Main to Inputs/Outputs</i></td> <td>250 Vac</td> </tr> <tr> <td><i>Input to Input</i></td> <td>250 Vac</td> </tr> <tr> <td><i>Input to Output</i> (except Digital Input to Current Output)</td> <td>250 Vac</td> </tr> <tr> <td><i>AC Main to Transmitter Power</i></td> <td>250 Vac</td> </tr> </table>	<i>AC Main to Inputs/Outputs</i>	250 Vac	<i>Input to Input</i>	250 Vac	<i>Input to Output</i> (except Digital Input to Current Output)	250 Vac	<i>AC Main to Transmitter Power</i>	250 Vac
<i>AC Main to Inputs/Outputs</i>	250 Vac								
<i>Input to Input</i>	250 Vac								
<i>Input to Output</i> (except Digital Input to Current Output)	250 Vac								
<i>AC Main to Transmitter Power</i>	250 Vac								
Options									
Current Output (Isolated)	<p>Range can be set anywhere between 4 mA and 21 mA, and as direct or reverse action.</p> <p><i>Resolution:</i> 11 bits for 4 mA to 21 mA <i>Accuracy:</i> 0.5 % full scale <i>Temperature Stability:</i> 0.1 % F.S./°C <i>Load Resistance:</i> 0 ohms to 600 ohms</p>								
Electromechanical Relay Output	<p>SPDT contacts. Internally socketed.</p> <p><i>Resistive Load:</i> 5 A @ 120 Vac or 2.5 A @ 240 Vac or 30 Vdc. <i>Inductive Load:</i> 50 VA @ 120 Vac or 240 Vac. <i>Motor:</i> 1/6 H.P.</p>								

Condition	Specifications
Solid State Relay Output	SPST solid state contacts consisting of a triac NO output. Internally socketed. <i>Resistive Load:</i> 1.0 A @ 25 °C for 120 Vac or 240 Vac. 0.5 A @ 55 °C for 120 Vac or 240 Vac. <i>Inductive Load:</i> 50 VA @ 120 Vac or 240 Vac.
Open Collector Output	<i>Maximum Sink Current:</i> 20 mA Internally powered @ 30 Vdc Opto-isolated from all other circuits except current output, but not from each other. Socketed jumper assembly replaces relay.
Modbus Communication	<i>Baud Rate:</i> 19,200 maximum, configurable for models with display; fixed at 9,600 for models without display <i>Protocol:</i> Modbus <i>Length of Link:</i> 1,219 m [4,000 ft] maximum <i>Link Characteristics:</i> Two-wire, multidrop
Digital Inputs (Supply common with current output)	+24 Vdc source for external dry contacts or isolated solid state contacts for either of the two inputs. On contact closure the recorder will respond according to how each digital input is configured. Opening contact causes return to previous state.
Transmitter Power	24 Vdc with adjustment of $\pm 6\%$ (22.6 to 25.4) 100 mA maximum output

2.2 Mounting Considerations and Overall Dimensions

Physical considerations

The recorder can be mounted flush in a panel or on the surface of a panel or wall using the mounting kit supplied with the recorder. Adequate access space must be available at the back of the panel for installation and servicing.

A kit for mounting the unit on a pipe is available (see *Section 9 Parts List*).

Overall dimensions

The overall dimensions and panel cutout requirements for mounting the recorder are shown in Figure 2-1.

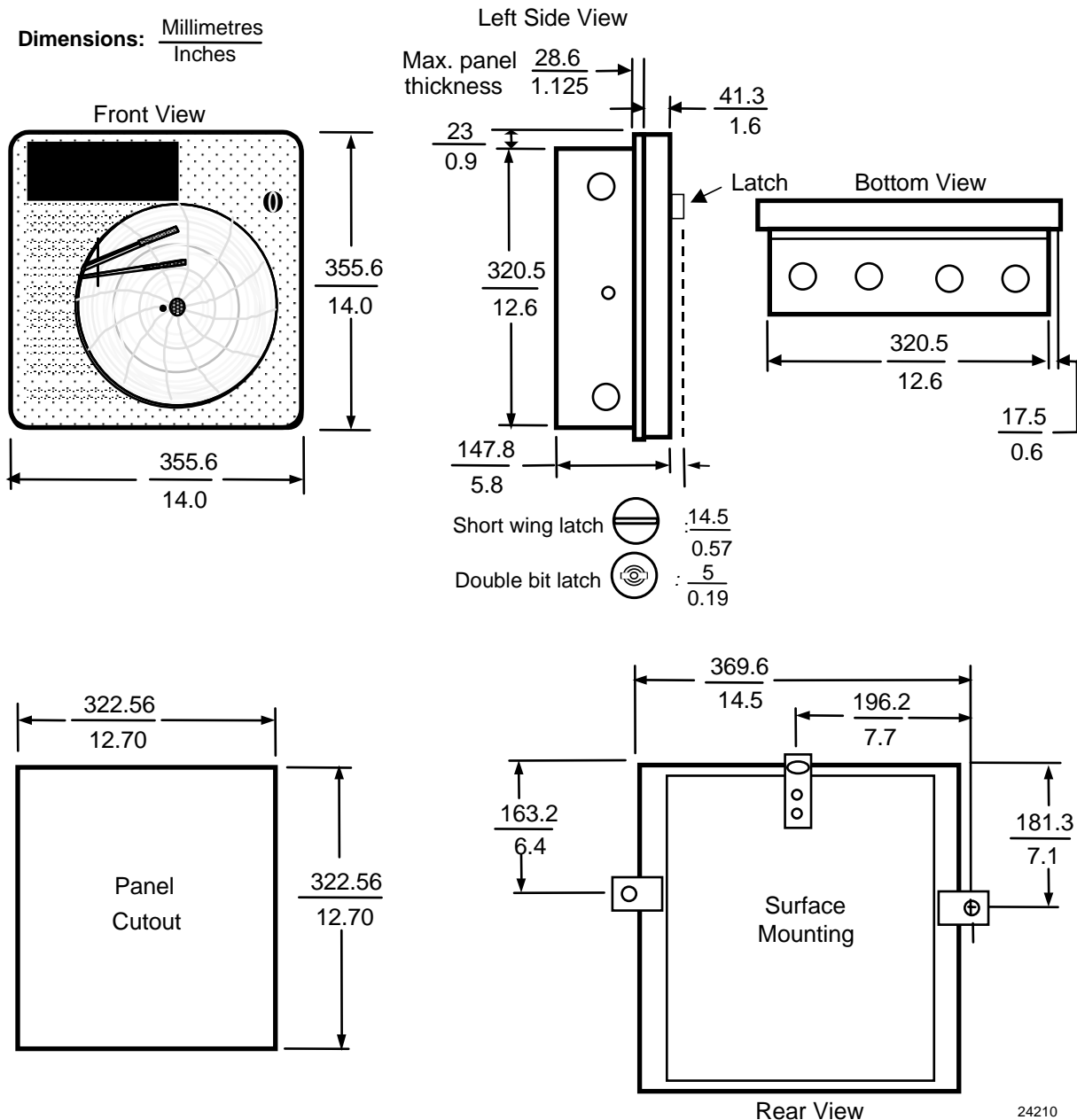

Figure 2-1 Overall Dimensions

2.3 Mounting Methods

2.3.1 Introduction

Overview

This section provides instructions for mounting the recorder using one of the following methods:

- Flush in a panel (Subsection 2.3.2)
- Flush in a panel for recorders with NEMA4 or Heavy Duty door (Subsection 2.3.3)
- On a 2-inch pipe (Subsection 2.3.4)
[A pipe mounting kit is available (see *Section 9 Parts List*).]
- On the surface of a wall or panel (see Subsection 2.3.5).

Choose the method that meets your mounting requirements. Use the associated dimension drawings for reference.

How to remove knockouts for conduits

Before you mount the recorder, remove the appropriate plugs in the bottom and/or sides of the recorder case for wire entry via 1/2" (12.7 mm) conduits. Refer to Figure 2-2 for plug locations. To see recommended use of conduits for various types of wiring, refer to Figure 2-7 and Figure 2-8.

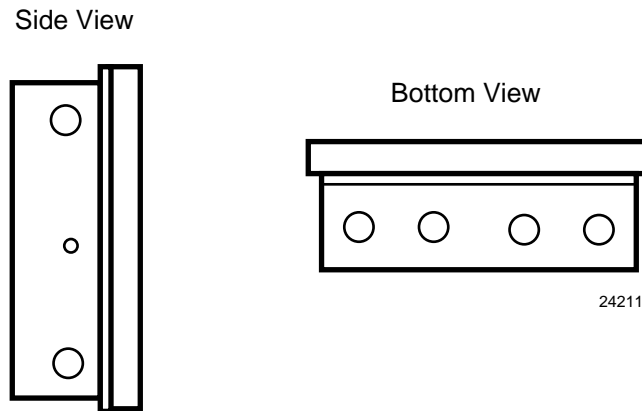

Figure 2-2 Plug Locations

2.3.2 Mounting Flush in Panel (New Panel Cutout)

Procedure

Refer to Figure 2-3 and follow the procedure in Table 2-2 to make a new cutout in a panel and mount your recorder in the cutout.

Table 2-2 Mounting Flush in a New Panel Cutout

Step	Action
1	At the appropriate location, make a square cutout in the panel. Cutout dimensions should be 322.56 mm \pm 1.52 mm x 322.56 mm \pm 1.52 mm [12.7 in \pm 0.060 in x 12.7 in \pm 0.060 in]. See Figure 2-3.
2	Orient the recorder case properly and slide it into the cutout from the front of the panel. Support the recorder as shown in Steps 3 and 4.
3	Refer to Figure 2-3. From the back of the panel, attach a mounting bracket to each side of the recorder case using a 1/4-20 x 1/2-inch hex screw for each bracket (mounting hardware supplied with recorder). Leave the screws slightly loose so you can adjust the brackets.
4	While holding the recorder firmly against the panel, slide each bracket against the back of the panel and tighten the screws.

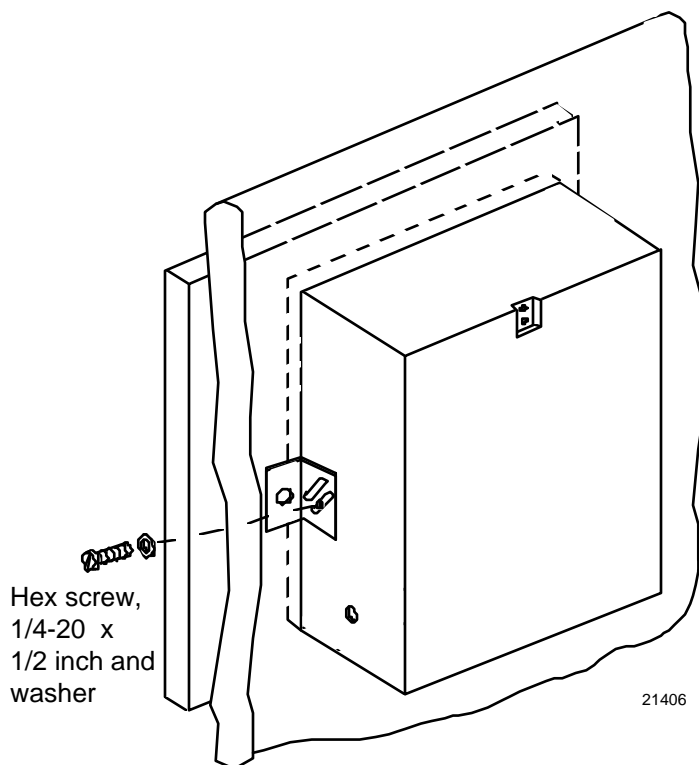

Figure 2-3 Mounting Flush in a New Panel Cutout (Rear View)

2.3.3 Panel Mounting Recorder with NEMA4 or Heavy Duty door

Refer to Figure 2-4 and follow the procedure in Table 2-3 to panel mount your recorder if it has a NEMA4 or Heavy Duty door.

Table 2-3 Procedure for Mounting Recorder with NEMA4 or Heavy Duty Door

Step	Action
1	Place the panel gasket onto the rear flange of the recorder case.
2	Install four #8-32 screws on each of the three mounting brackets so the ends of the screw threads are flush with the face of the bracket. NOTE: Screw heads to be flange side of brackets.
3	Insert the case with gasket into the panel opening.
4	Install one left hand and one right hand bracket with 1/4 x 3/8 long bolts and lockwashers on each side of the case. NOTE: The notch on each bracket should be facing upward towards the top of the unit. <i>Do not tighten the hex bolts at this time.</i>
5	Install the remaining right hand bracket on the top with the 1/4 x 3/4 long bolt and lockwasher. <i>Do not tighten the bolt at this time.</i>
6	Place a screwdriver blade on the notch of each bracket and firmly tap so that each bracket firmly mates the case with gasket to the panel. NOTE: Keep brackets parallel to case. Tighten the three 1/4 hex bolts to hold the brackets in place.
7	Start to tighten the #8-32 x 1/2 screws on the right side bracket. Alternate screws at opposite ends until all four screws have a minimum of 10 lb-in of torque applied. Do the same to both the left side and top brackets. When completed all twelve screws should have a minimum of 10 lb-in of torque applied. This assures the case and panel gasket are adequately sealed against the panel.

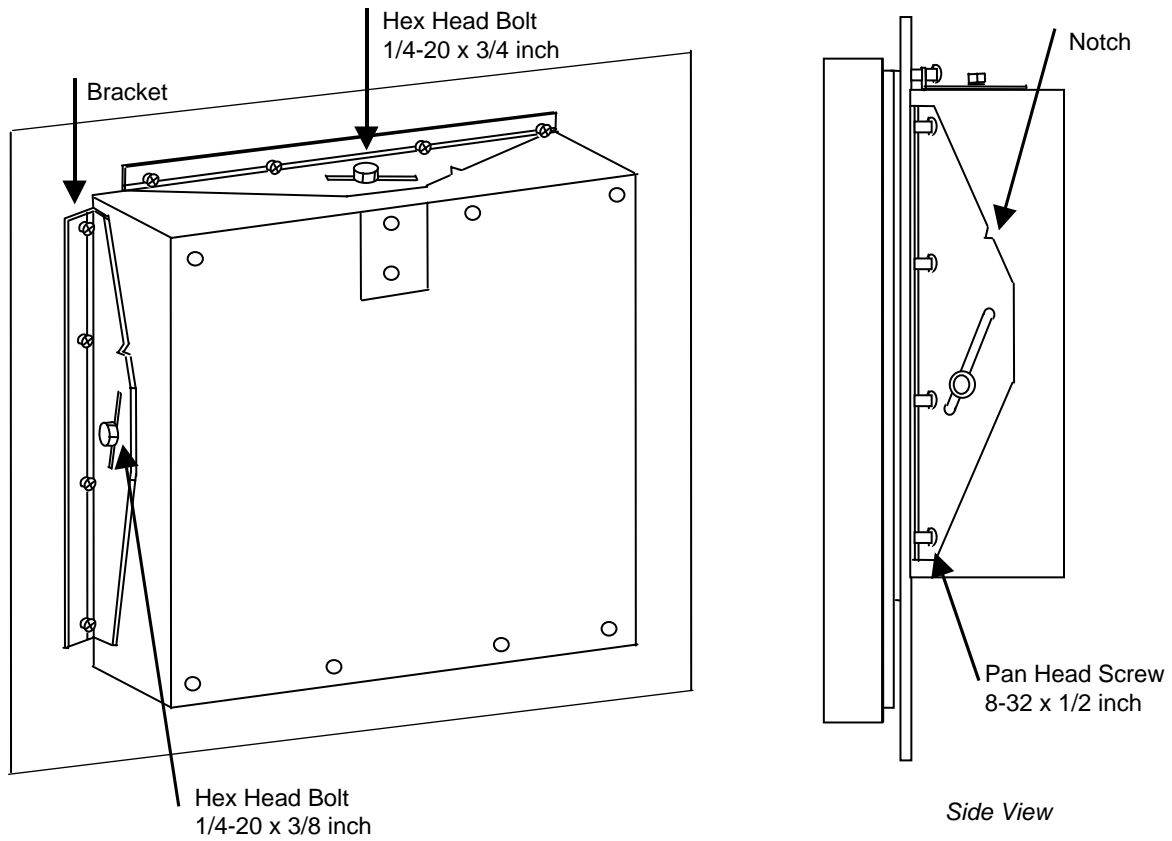

NOTE: Mounting brackets and attaching hardware are included in kit 30755065-502; panel gasket supplied in kit 51197657-501.

Figure 2-4 Panel Mounting Recorder with NEMA4 or Heavy Duty Door

2.3.4 Mounting on a 2-inch pipe

Refer to Figure 2-5 and follow the procedure in Table 2-4 to mount your recorder on a 2-inch pipe.

Table 2-4 Pipe Mounting Procedure

Step	Action
1	Using the eight plastite screws supplied with the pipe mounting bracket kit, attach the two mounting brackets (flat side against the case) to the back of the recorder. Refer to Figure 2-5 for location.
2	Position the recorder with brackets on the 2-inch pipe.
3	Install the U-bolts around the pipe and through the bracket holes. Secure with lockwashers and hex nuts provided.

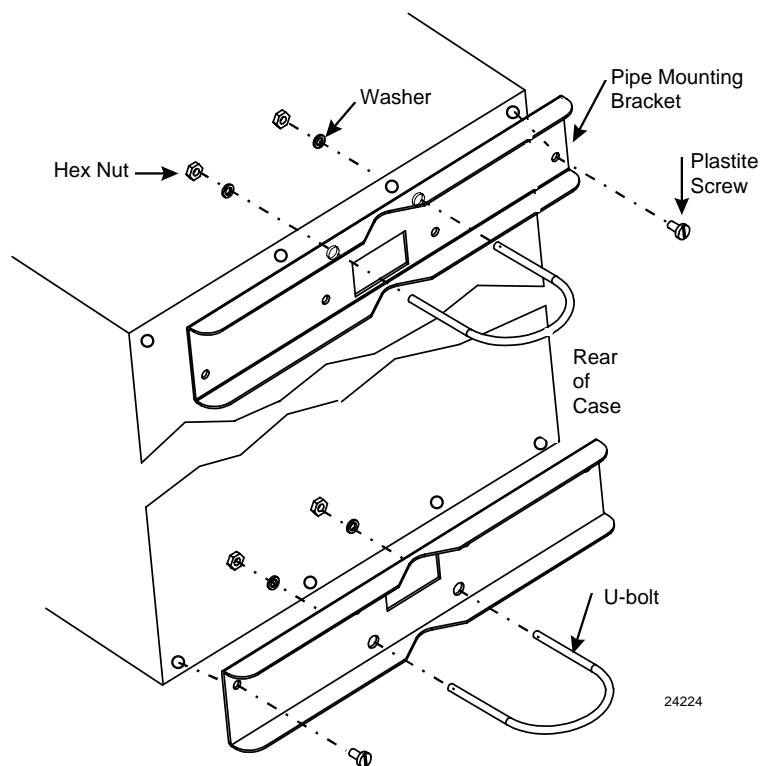

Figure 2-5 Pipe Mounting Brackets

2.3.5 Mounting on Surface (of Panel or Wall)

Procedure

Refer to Figure 2-6 and follow the procedure in Table 2-5 to mount your recorder on a surface (panel or wall).

ATTENTION

Three (3) screws must be supplied by the user for attaching the mounting hardware (brackets and support hook) to panel or wall.

Table 2-5 Mounting Flush on a Surface (of Panel or Wall)

Step	Action
1	Using two flat-head 10-32 x 1/4-inch screws supplied with the recorder, fasten the support hook into the recess at the back of the recorder case as shown in Figure 2-6.
2	Using 1/4-20 x 1/2-inch hex screws and lockwashers, attach a mounting bracket to each side of the case. Leave the screws slightly loose so as to permit some adjustments of the brackets.
3	On the panel, mark the locations for the three holes, as shown by the hole pattern in Figure 2-6.
4	Using a drill of appropriate size for user-supplied screws, drill a hole in the front of the panel for the eye of the support hook.
5	Insert the screws for the support hook into the panel, allowing the screw head to protrude approximately 5/16-inch.
6	Hang the recorder support hook on the screw. Make sure that the locations for the other two holes (marked in Step 3) are correct. If not, make sure that the recorder is aligned vertically, and use the brackets as templates to mark the proper locations.
7	Remove the recorder from the panel and drill the other two holes.
8	Hang the recorder on the screw by the support hook and insert the other two user-supplied screws through the brackets into the panel. Tighten the two hex screws that attach the brackets to the case.

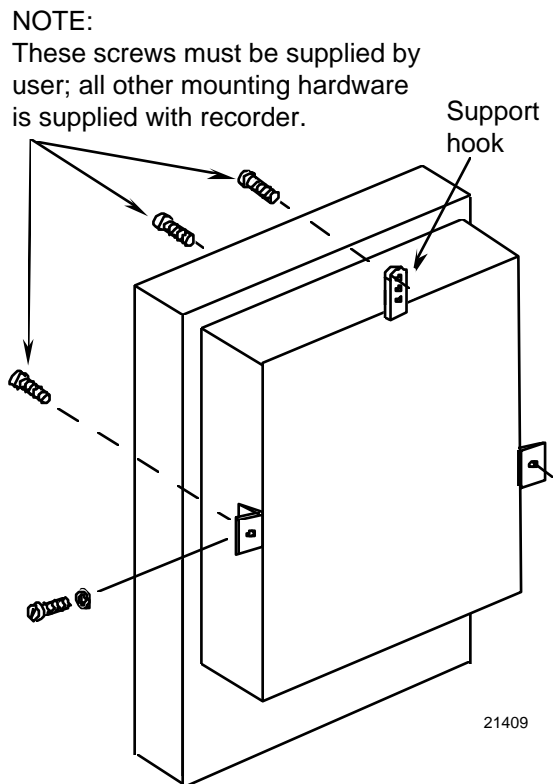
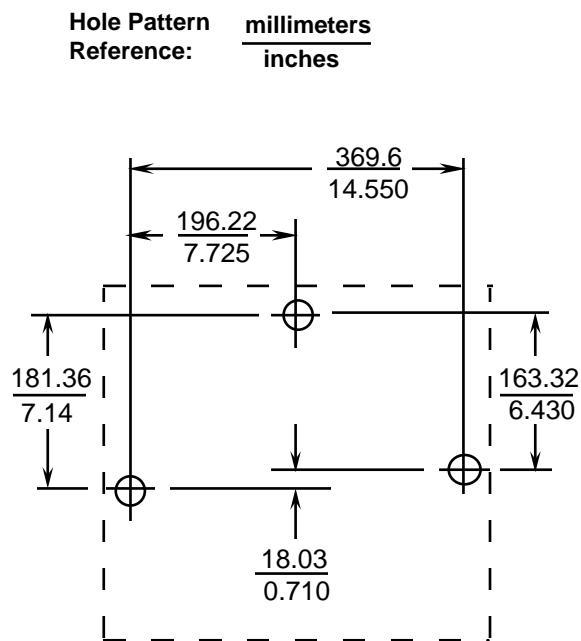

Figure 2-6 Mounting Flush on a Surface of Panel or Wall (Rear View)

2.4 Wiring Prerequisites

ATTENTION

Wiring should be performed by qualified personnel.

Electrical considerations



The recorder is considered “rack and panel mounted equipment” per EN 61010-1, Safety Requirements for Electrical Equipment for Measurement, Control, and Laboratory Use, Part 1: General Requirements.

Recorder grounding



PROTECTIVE EARTH (GROUND)

Grounding of this recorder shall be in accordance with national and local electrical codes.



NOISELESS (CLEAN) EARTH (GROUND)

To minimize electrical noise and transients that may adversely affect the recorder, connection of the recorder terminal (located in the rear of the case) to a local earth (ground) using a No. 11 (4 mm²) braided copper conductor is recommended.

Taking electrical noise precautions

Electrical noise is composed of unabated electrical signals which produce undesirable effects in measurement and control circuits.

Digital equipment is especially sensitive to the effects of electrical noise. Your recorder has built-in circuits to reduce the effect of electrical noise from various sources. If there is a need to further reduce these effects:

- **Separate External Wiring**—Separate connecting wires into bundles (see Table 2-6) and route the individual bundles through separate conduits or metal trays.
- **Use Suppression Devices**—For additional noise protection, you may want to add suppression devices at the external source. Appropriate suppression devices are commercially available.

For additional noise information, refer to document 51-52-05-01, *How to Apply Digital Instrumentation in Severe Electrical Noise Environments*.

CE conformity special conditions (Europe)

Shielded cables with a drain wire are required for all input and output cables. All instrument shielded cable drain wires must be connected to a low impedance earth ground at the entry fitting. Cable/conduit entry fittings shall effectively terminate the cable shield connecting the shield to the enclosure conductive coating. The shielded cable shield shall not extend into the instrument closure.

Recommended wiring routing

The case is equipped with numerous knock-outs (plugs) for wiring conduits (see Figure 2-2). To see recommended use of these points of entry for various types of wiring, refer to Figure 2-7 and Figure 2-8.

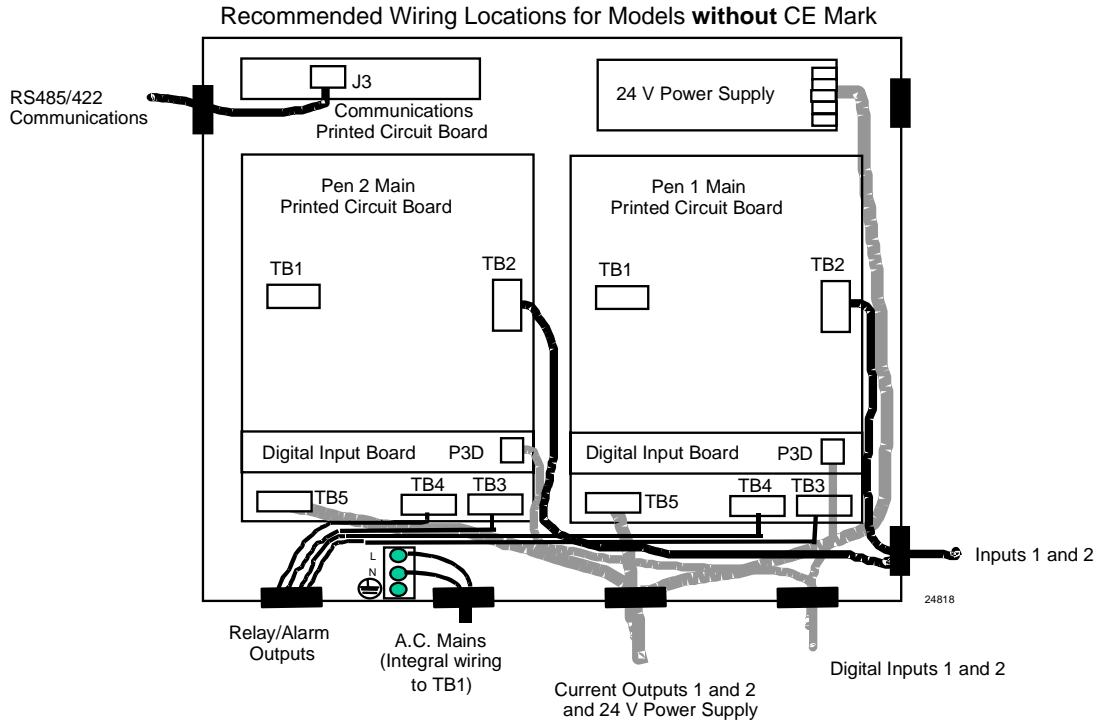
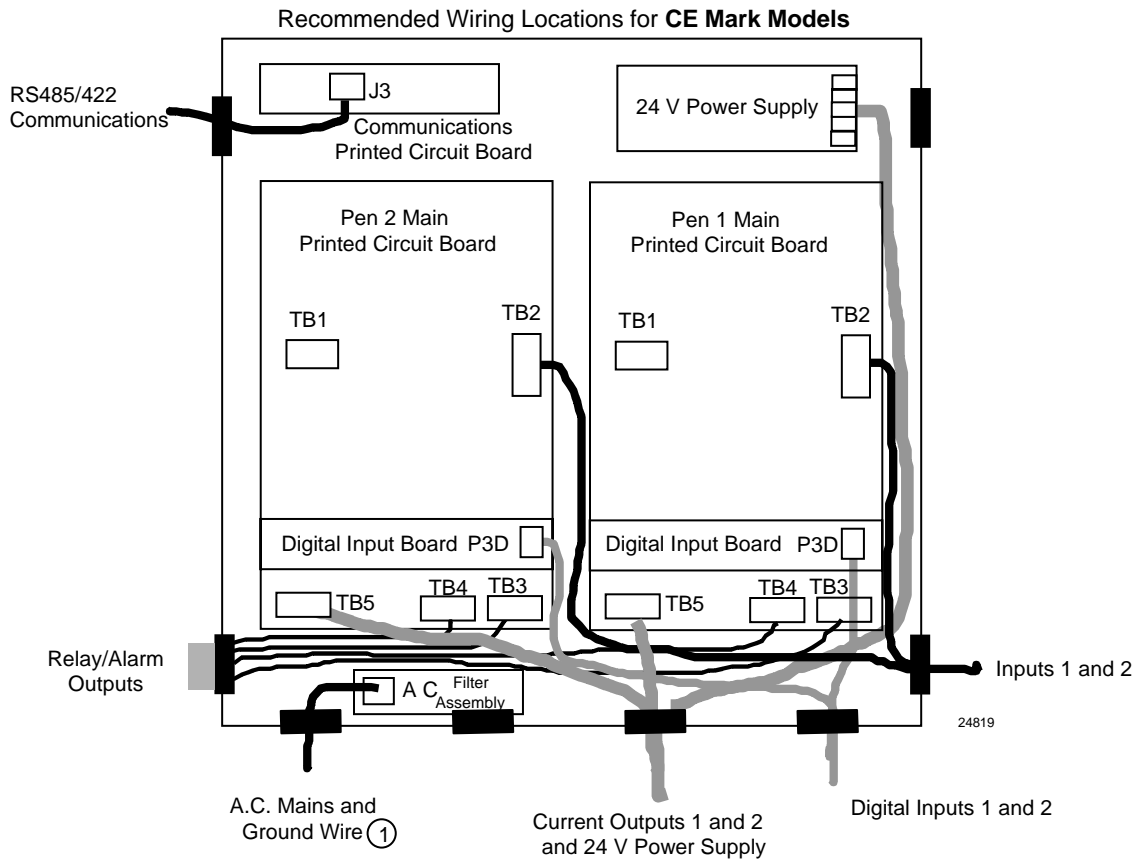

Figure 2-7 Recommended Wiring Routing - Models Without CE Mark



- ① A braided copper shield shall be connected to ground (green screw on the filter assembly).
A separate braided copper shield shall be used to connect \perp on rear of case to chassis ground

Figure 2-8 Recommended Wiring Routing - Models With CE Mark

Wire bundling recommendations

Bundling together the wrong wires can adversely affect the recorder's performance. Table 2-6 shows which wire functions may usually be bundled together. **Do not bundle together wires from different categories.**

Table 2-6 Wiring Bundling Categories

Category	Wire Functions
1	<ul style="list-style-type: none"> • Line power wiring • Earth ground wiring • Control relay output wiring • Line voltage alarm wiring
2	Analog signal wire, such as: <ul style="list-style-type: none"> • Input signal wire (thermocouple, 4 to 20 mA, etc.) • 4-20 mA output signal wiring • Digital input wiring • Communication wiring • Transmitter power out wiring
3	<ul style="list-style-type: none"> • Low voltage alarm relay output wiring • Low voltage wiring to solid state type control circuits

Wiring diagrams

To determine the appropriate diagrams for wiring your recorder, refer to the model number interpretation in *Section 1 - Overview*. The model number of the recorder can be found on the chart plate.

Using the information contained in the model number, select the appropriate wiring diagrams from the figures listed in Table 2-7 and wire the recorder accordingly.

Table 2-7 Wiring Illustrations

Wiring Requirements	See
Power Wiring - Models Without CE Mark	Figure 2-9
Power Wiring - Models With CE Mark	Figure 2-10
Analog Input Wiring	Figure 2-11
Digital Input Wiring	Figure 2-12
Communication Wiring	Figure 2-13
Relay Output Wiring	Figure 2-14
Open Collector Relay Output Wiring	Figure 2-15
Current Output Wiring	Figure 2-16
Transmitter Power Out Wiring	Figure 2-17

2.5 Input Wiring

Introduction

This section describes procedures for wiring power, analog inputs, optional digital inputs, and the optional communication link.

2.5.1 Power Wiring

Introduction

Recorder models are available for use with 100 to 240 Vac or 20 Vdc to 27 Vdc power. (See Model Number in *Section 1 Overview*.)

Procedure

The procedure to connect power wiring is in Table 2-8.

- See
- Figure 2-9 for models without CE Mark.
- See
- Figure 2-10 for models with CE Mark.

WARNING



SHOCK HAZARD

Be sure that the line voltage is OFF before connecting the power wires to the recorder.
Failure to observe this precaution can result in serious personal injury or death.

CAUTION



This equipment is suitable for connection to 100 to 240 Vac (49 to 61 Hz) or 20 to 27 Vac/Vdc power supply mains. It is the user's responsibility to provide a switch and non-time delay (North America), quick-acting, high breaking capacity, Type F, (Europe) 1/2 A, 250 V fuse(s) or circuit-breaker as part of the installation. The switch or circuit-breaker shall be located in close proximity to the recorder, within easy reach of the operator. The switch or circuit-breaker shall be marked as the disconnecting device for the recorder.

Table 2-8 Procedure for Power Wiring Models

Step	Action
1	Open the recorder door. Loosen the captive screw in the chart plate and swing the plate out.
2	Locate the power terminal block for your recorder model. <ul style="list-style-type: none"> • See Figure 2-9 for models without CE Mark. • See Figure 2-10 for models with CE Mark. Note that the power connection between the boards on two-pen models is made at the factory. On CE Mark and UL models the connection between the terminal block at the bottom of the case and the PCA is also made at the factory. In all models, you only have to connect power to a single terminal block.
3	Run the power wires separately through the conduit hole indicated in Figure 2-7 or Figure 2-8.
4	Strip 1/4-inch maximum of insulation from the end of each wire and form end to fit under a screw connection.
ATTENTION: To avoid damaging the recorder, be sure that you install the power wires into the correct screw terminals as shown Figure 2-9 and Figure 2-10.	
5	Tighten the screws to secure the wires.
6	Dress the wires with as much slack as possible. Do not bundle any low level signal wires with the power wires. Refer to Table 2-6 for permissible wire bundling. Refer to Appendix A for additional information concerning noise interference prevention.
	WARNING SHOCK HAZARD Input line voltage may be present on the instrument ground plane if earth ground is not attached. Failure to observe this precaution can result in serious personal injury.

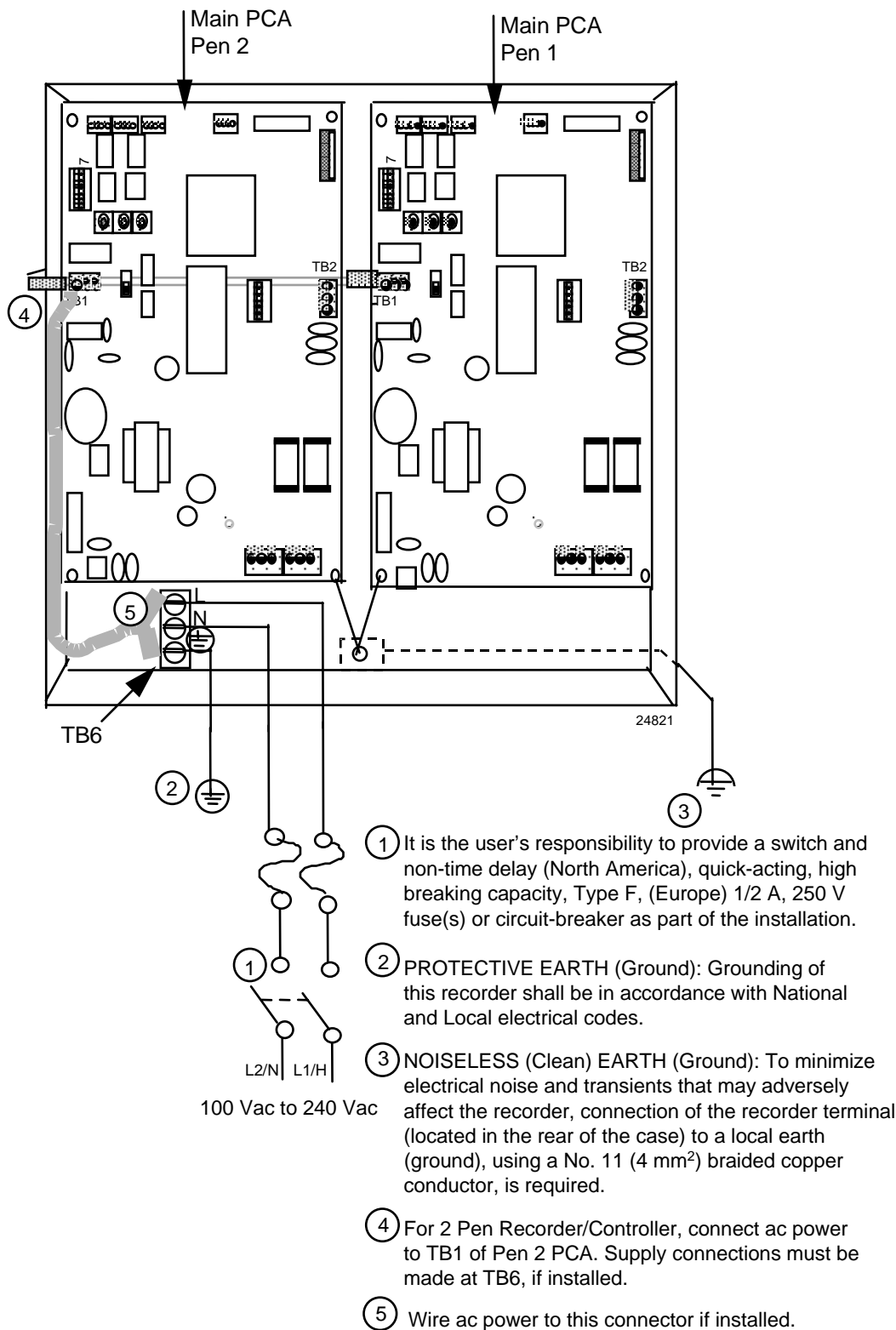

Figure 2-9 Power Wiring – Models Without CE Mark

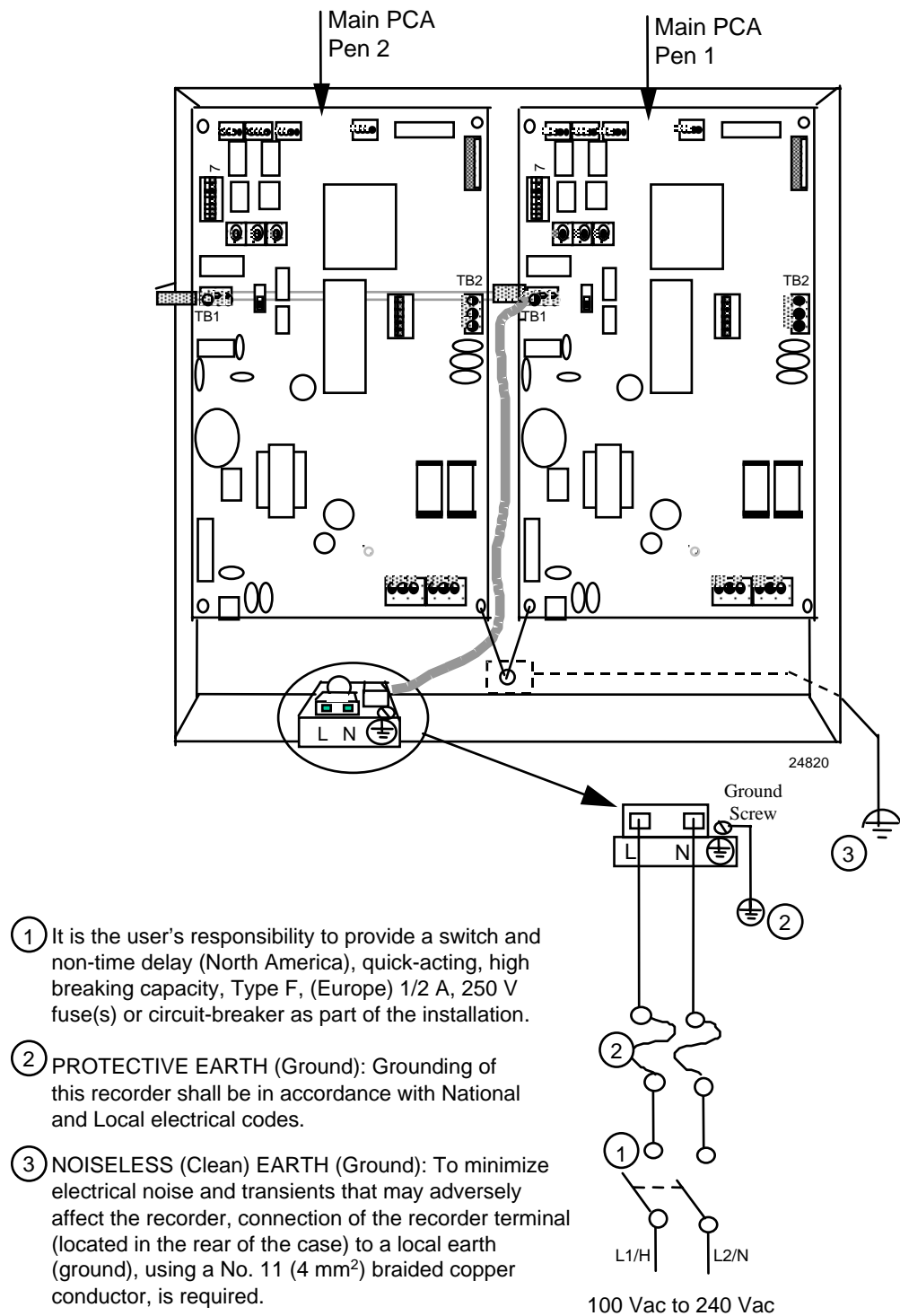

Figure 2-10 Power Wiring – Models With CE Mark

2.5.2 Analog Input Wiring

Introduction

The input for pen channel 1 is wired to TB2 on the printed circuit assembly (PCA) on the right (when facing recorder). The input for pen channel 2 is wired to TB2 on the PCA on the left.

Each input can be wired for thermocouple, RTD, mA, mV, or Volt actuations.

ATTENTION

Make sure you have configured the recorder to accept the desired input type. See Section 3 – Configuration, Startup, and Operation of Recorder Without Display or Section 4 – Configuration, Startup, and Operation of Recorder With Display.

Procedure

Refer to Figure 2-11 while following the procedure in Table 2-9 to install analog input wiring.

Table 2-9 Analog Input Wiring

Step	Action
ATTENTION To avoid damaging the recorder, be sure that you install the power wires into the correct screw terminals as shown in Figure 2-9 and Figure 2-10.	
1	Turn off the power to the recorder.
2	Open the recorder door. Loosen the captive screw in the chart plate and swing the plate out.
3	Locate terminal block TB2 on the right edge of the printed circuit assembly for pen 1 (refer to Figure 2-11).
4	Run the input wires through the appropriate conduit hole (see Figure 2-7 and Figure 2-8). DO NOT bundle them with the power wires.
5	Strip 1/4-inch maximum of insulation from the end of each wire and form end to fit under the screw terminal on the removable connection block.
6	Insert the wires under the appropriate screws for the applicable input type. See Figure 2-11 for specific input actuation wiring. Tighten the screws to secure the wires.
7	If the recorder has two pens, repeat Steps 3 through 6 to wire the input for the second pen channel to TB2 on the PCA on the left inside of the recorder.

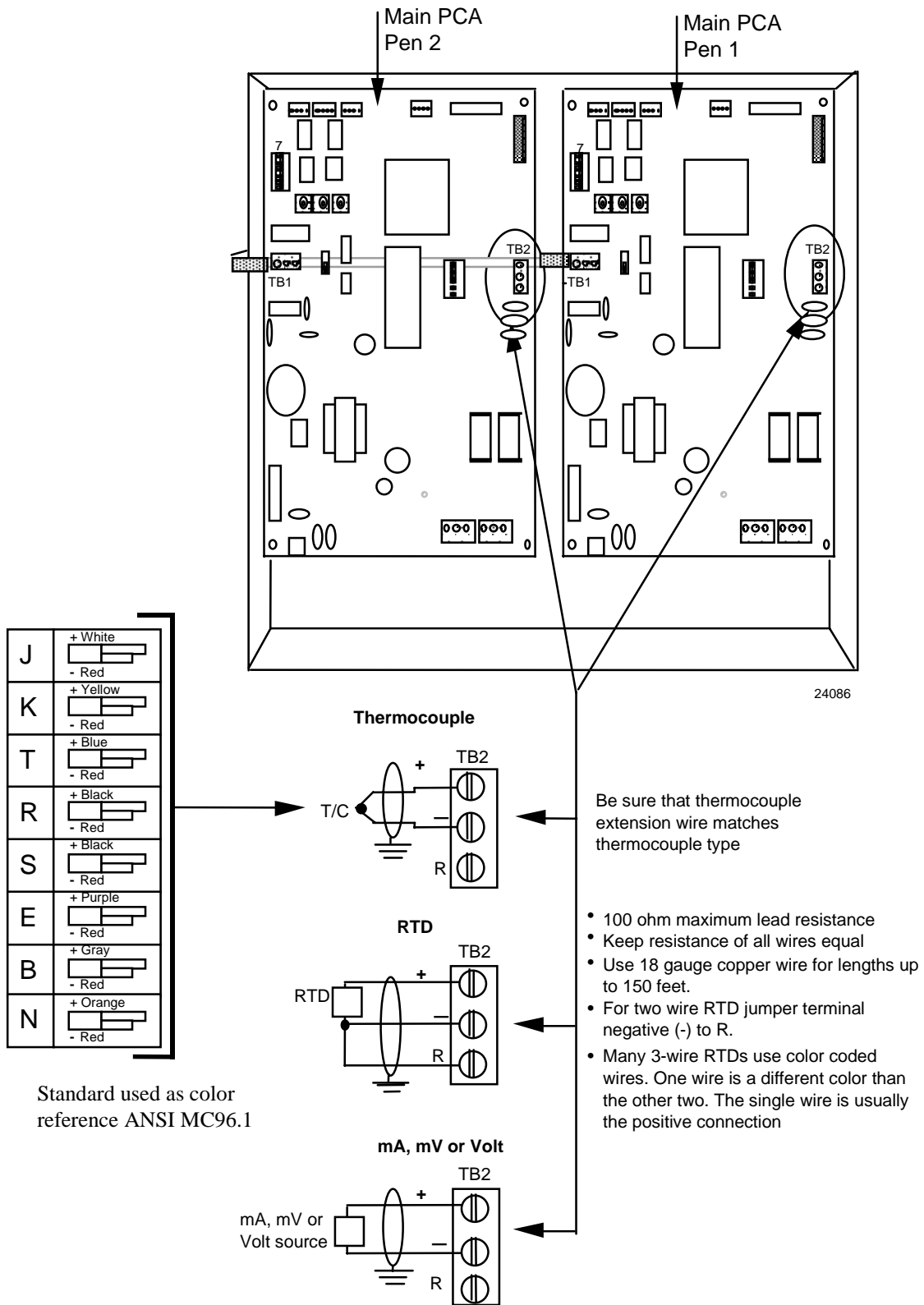

Figure 2-11 Analog Input Wiring

2.5.3 Digital Inputs (Optional)

Introduction

If the recorder hardware supports optional digital inputs, the inputs are wired to the terminal block on the digital input board mounted on stand-offs on the printed circuit assembly for the pen channel.

Procedure

Refer to Figure 2-12 while following the procedure in Table 2-10 to install digital input wiring.

Table 2-10 Digital Input Wiring

Step	Action
ATTENTION To avoid damaging the recorder, be sure that you install the power wires into the correct screw terminals as shown in Figure 2-9 and Figure 2-10.	
1	Open the recorder door. Loosen the captive screw in the chart plate and swing the plate out.
2	Locate the terminal block, P3D, on the optional digital input printed circuit assembly mounted on stand-offs above the printed circuit assembly (PCA) for the pen channel. The PCA on the right inside the recorder is for pen 1; if there is a second pen, its PCA is on the left. (See Figure 2-12.)
3	Run the input wires through the appropriate conduit hole (see Figure 2-7 and Figure 2-8). DO NOT bundle them with the power wires.
4	Strip 1/4-inch maximum of insulation from the end of each wire and form end to fit under a screw connection.
5	Insert the wires under the appropriate screws for the input number (labeled on assembly). Tighten the screws to secure the wires.
6	If the recorder has two pens, repeat Steps 2 through 5 to wire the input for the second pen channel.

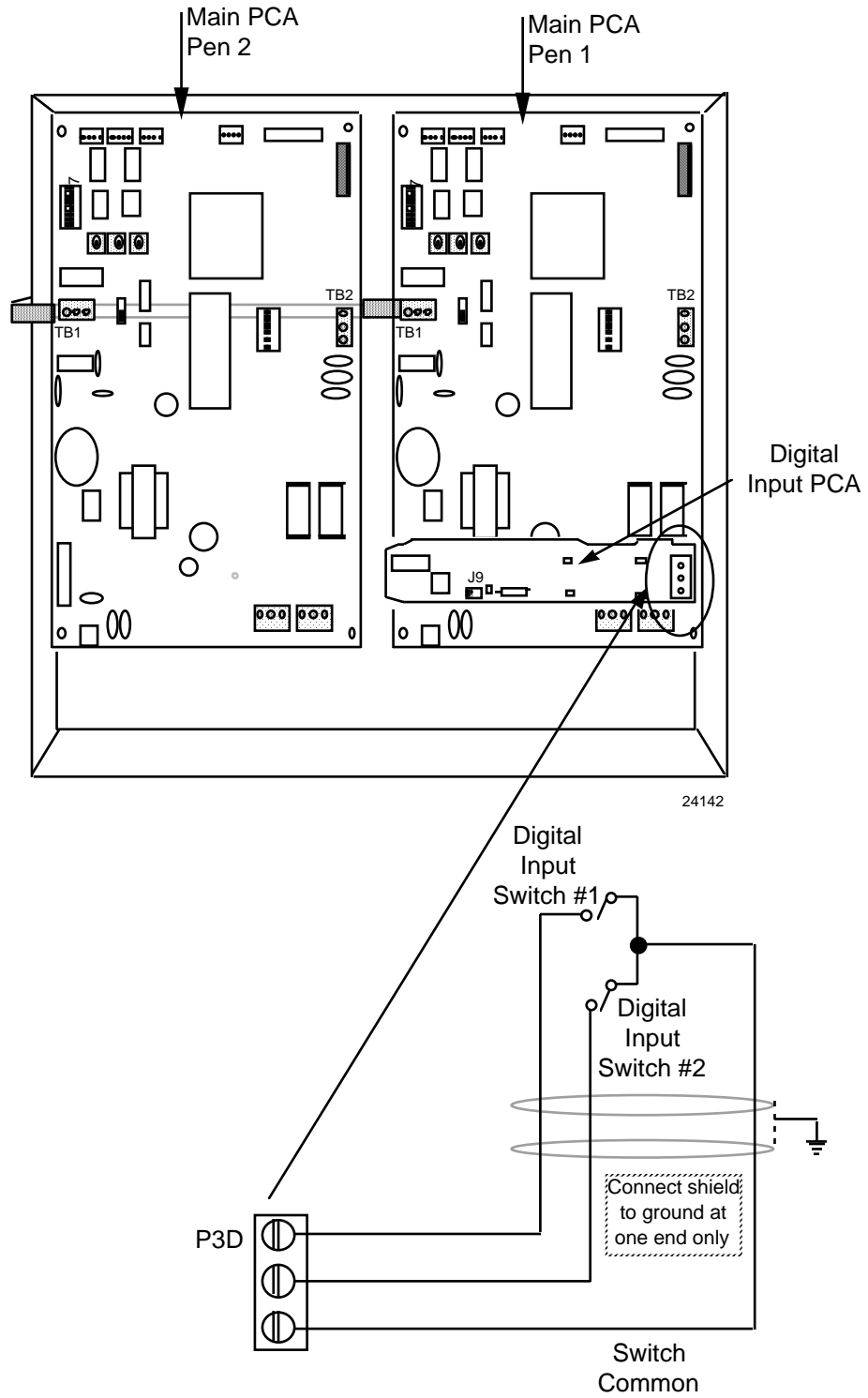

Figure 2-12 Digital Input Wiring

2.5.4 Communication (Optional)

Introduction

If the recorder hardware supports optional Modbus RTU communication, the communication link is wired to the terminal block on the communication board in the upper left corner of the case.

ATTENTION

Network address, baud rate, and transmitter delay are configurable for models with a display (see *Section 4*).

For models without a display the address of pen 1 is fixed at 127, baud rate is fixed at 9600, and there is no transmitter delay. Only one pen channel with the fixed address of 127 can be on the network. Pen channel 2, if present in the recorder, cannot communicate. (Display is required to configure a unique address for the second pen to communicate.)

Procedure

Refer to Figure 2-13 while following the procedure in Table 2-11 to install communication wiring.

Table 2-11 Communication Wiring

Step	Action
ATTENTION To avoid damaging the recorder, be sure that you install the power wires into the correct screw terminals as shown Figure 2-9 and Figure 2-10.	
1	Open the recorder door. Loosen the captive screw in the chart plate and swing the plate out.
2	Locate the terminal block on the optional communication printed circuit assembly in the upper left corner of the case. (See Figure 2-13.)
3	Run the communication wires through the appropriate conduit hole (see Figure 2-7 and Figure 2-8). DO NOT bundle them with the power wires.
4	Strip 1/4-inch maximum of insulation from the end of each wire and form end to fit under a screw connection.
5	Insert the wires under the appropriate screws (labeled on assembly). Tighten the screws to secure the wires.

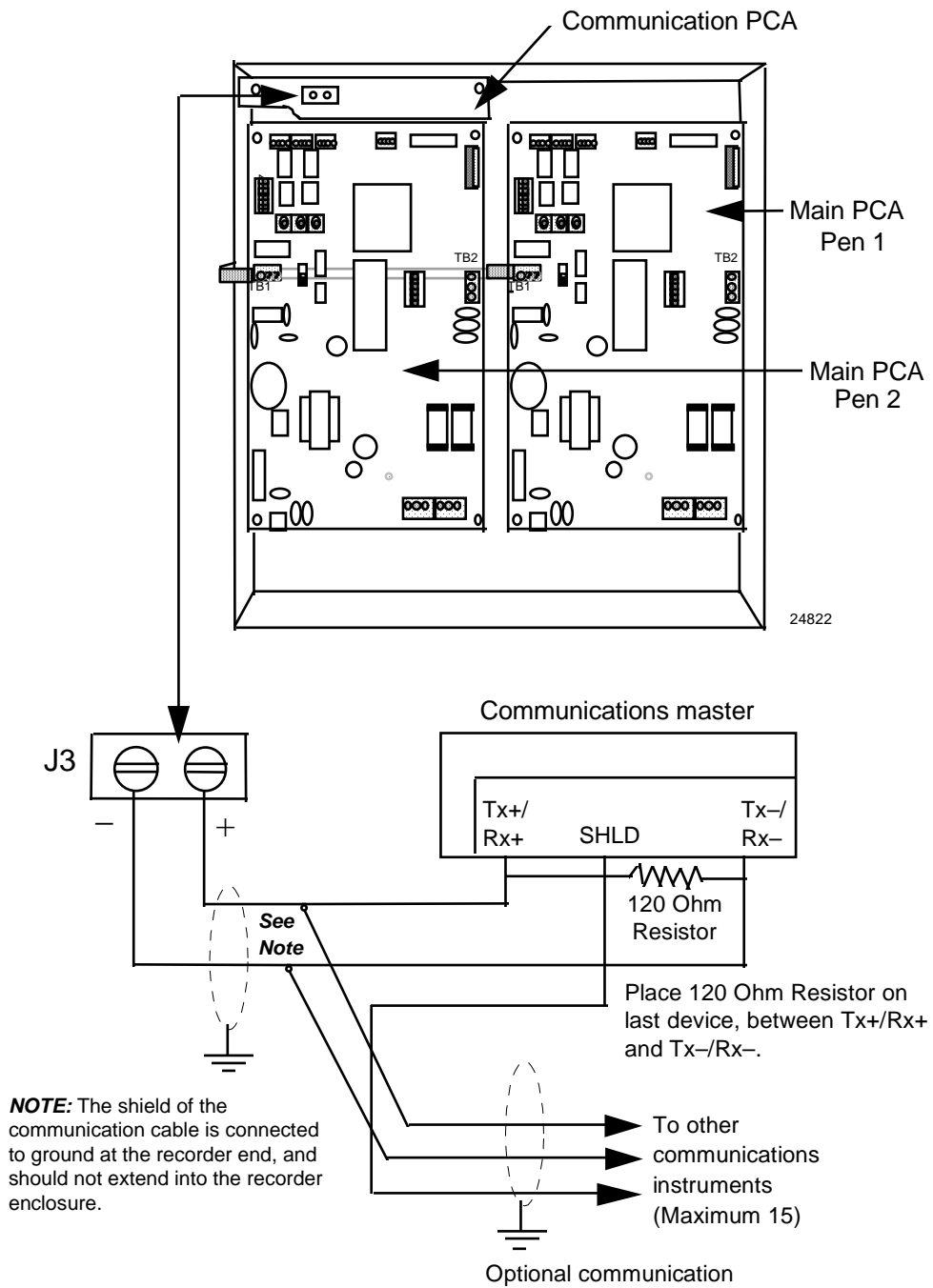

Figure 2-13 Communication Wiring

2.6 Output Wiring

ATTENTION

The recorder is available with several options and multiple output algorithms. Output terminal use depends on which output algorithm and options are used. The wiring diagrams in this section show how to wire the terminals. To see which terminals are used for what output function, refer to Table 2-12. This table applies to all control types. Each pen channel is configured separately, and each can use a different output algorithm. (The output algorithm is set with the control set up group “OUTALG” parameter.)

Table 2-12 Output Terminal Use for Output Algorithm and Option Combinations

OUTALG value	Terminal Function		
	Current Out (TB5)	Relay 1 (TB4)	Relay 2 (TB3)
NONE	auxiliary output*	alarm 1	alarm 2 or timer*
RLY	auxiliary output*	control	alarm 2 or timer*
RLYD	auxiliary output*	control 1 (heat)	control 2 (cool)
CUR	control	alarm 1	alarm 2 or timer*
CurT	control (cool)	control (heat)	alarm 2 or timer*
Tcur	control (heat)	control (cool)	alarm 2 or timer*

*Option

2.6.1 Discrete Outputs

Introduction

Each pen channel in the recorder models having display and keypad can be equipped with two optional discrete outputs. These outputs can be used for control or alarming, depending on the configuration as described in *Section 4 – Configuration, Startup, and Operation of Recorder with Display*.

Three types of discrete outputs are available:

- electromechanical relay
- solid state relay
- open collector output

ATTENTION

The electromechanical relays on the printed circuit assembly (PCA) for each pen channel can be wired for Normally Open (NO) and Normally Closed (NC) operation.

ATTENTION

The DR4300 is available as a limit controller. In a limit controller each pen channel’s printed circuit assembly Relay 1 (TB4 terminals 3 and 2 for NO contacts, and 2 and 1 for NC contacts) is used for limit control. When the recorder detects that the input has exceeded the limit (or fallen below the limit, depending on configuration), the controller goes to the limit state: Relay 1 is de-energized.

Insulation of output wires

The insulation of wires connected to the relay output terminals shall be rated for the highest voltage involved. Extra Low Voltage (ELV) wiring (input, current output, and low voltage control/alarm circuits) shall be separated from HAZARDOUS LIVE (>30 Vac, 42.4 V_{peak} or 60 V_{dc}) wiring per Table 2-6.

Procedure

Follow the procedure in Table 2-13 to wire the discrete outputs.

Refer to Figure 2-14 for wiring electromechanical and solid state relays.

Refer to Figure 2-15 for wiring open collector outputs.

Refer to Table 2-12 to see the output function of each terminal with the available output algorithms and options.

Table 2-13 Relay Output Wiring - 1 or 2 Pen Models

Step	Action
ATTENTION To avoid damaging the recorder, be sure that you install the power wires into the correct screw terminals as shown in Figure 2-9 and Figure 2-10.	
1	Turn off the power to the recorder.
2	Open the recorder door. Loosen the captive screw in the chart plate and swing the plate out.
3	Locate terminal blocks TB3* and TB4* on the bottom right edge of the printed circuit assembly (PCA) for pen 1 or pen 2.
4	Run the output wires through the appropriate conduit hole (see Figure 2-7 and Figure 2-8). DO NOT bundle them with input wires.
5	Strip 1/4-inch maximum of insulation from the end of each wire and form end to fit under a screw connection.
6	Insert the wires under the appropriate screws for the applicable relay output as shown in the figures. Tighten the screws to secure the wires.

*TB3 is output 2.

TB4 is output 1.

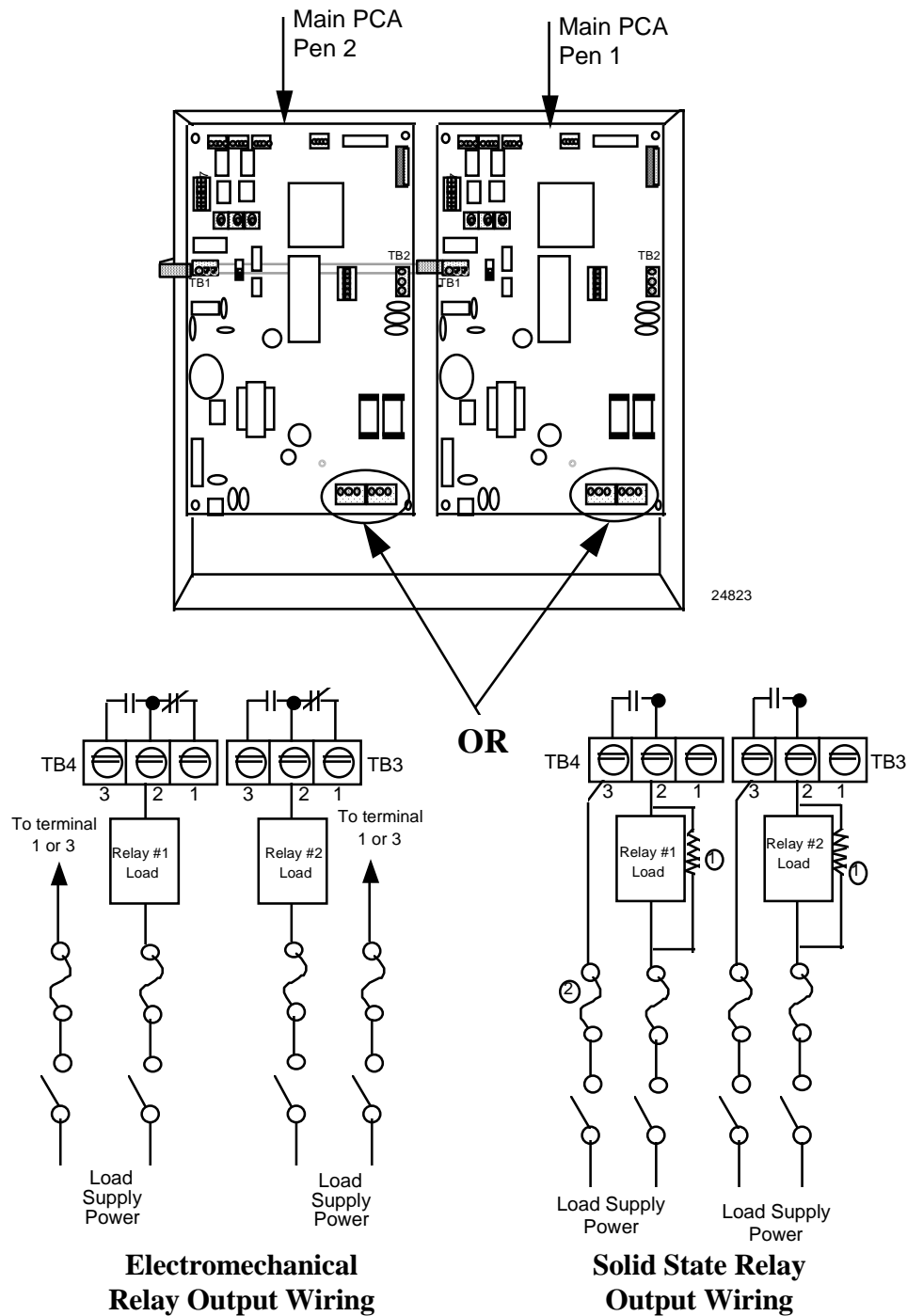

- ① If the load current is less than the minimum rated value of 20 mA, there may be a residual voltage across both ends of the load even if the relay is turned off. Use a dummy resistor as shown to counteract this. The total current through the resistor and the load current must exceed 20 mA.
- ② Solid State relays are rated at 0.5 Amps. Size fuses accordingly.

Figure 2-14 Relay Output Wiring

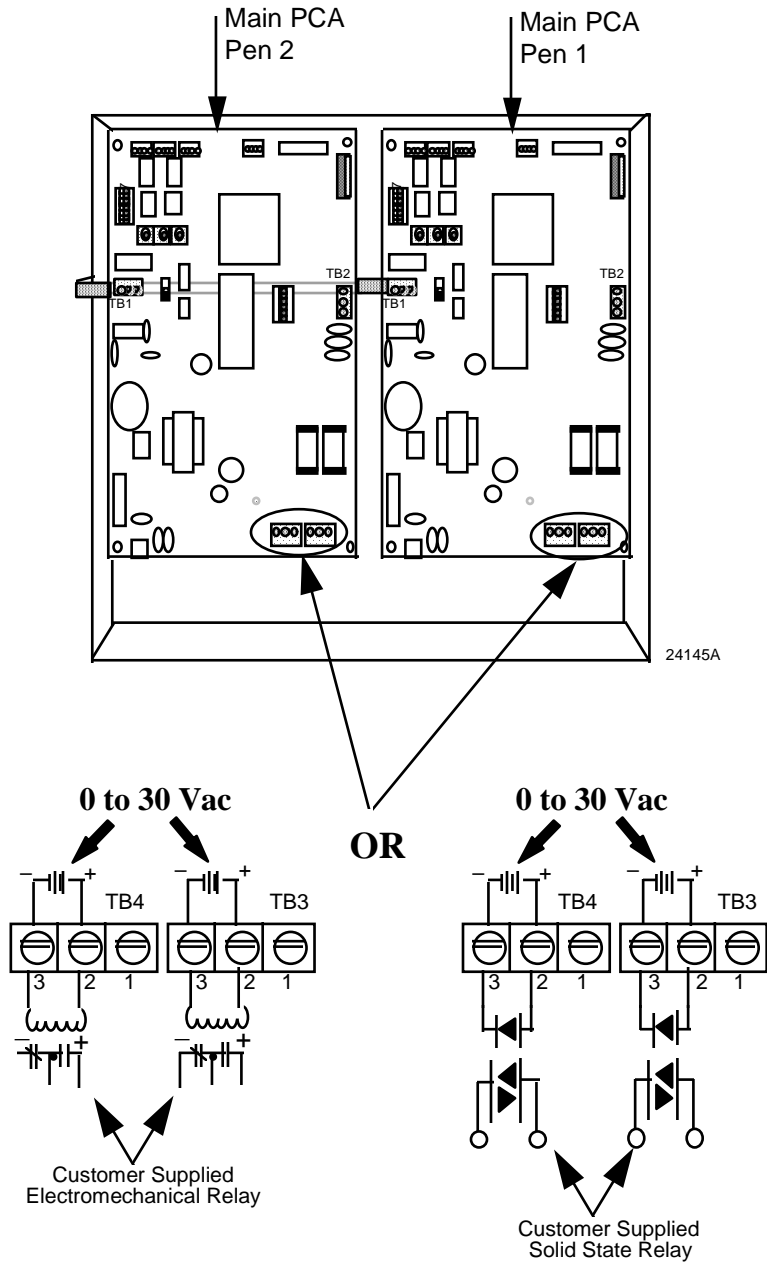

Figure 2-15 Open Collector Output Wiring

2.6.2 Current Output

Introduction

4 to 20 mA current outputs are optionally available for each pen channel in the recorder models having display and keypad.

Insulation of output wires

The insulation of wires connected to the relay output terminals shall be rated for the highest voltage involved. Extra Low Voltage (ELV) wiring (input, current output, and low voltage control/alarm circuits) shall be separated from HAZARDOUS LIVE (>30 Vac, 42.4 V_{peak} or 60 Vdc) wiring per Table 2-6.

Procedure

Refer to Figure 2-16 and follow the procedure in Table 2-14 to wire the current outputs.

Refer to Table 2-12 to see the output function of TB5 with the available output algorithms and options.

Table 2-14 Current Output Wiring

Step	Action
ATTENTION To avoid damaging the recorder, be sure that you install the power wires into the correct screw terminals as shown in Figure 2-9 and Figure 2-10.	
1	Turn off the power to the recorder.
2	Open the recorder door. Loosen the captive screw in the chart plate and swing the plate out.
3	Locate terminal block TB5 on the printed circuit assembly (PCA) for pen 1 or pen 2. (See Figure 2-16.)
4	Run the output wires through the appropriate conduit hole (see Figure 2-7 and Figure 2-8). Refer to Table 2-6 for acceptable wire bundling.
5	Strip 1/4-inch maximum of insulation from the end of each wire and form end to fit under a screw connection.
6	Insert the wires under the appropriate screws for the applicable relay output as shown in the figure. Tighten the screws to secure the wires.

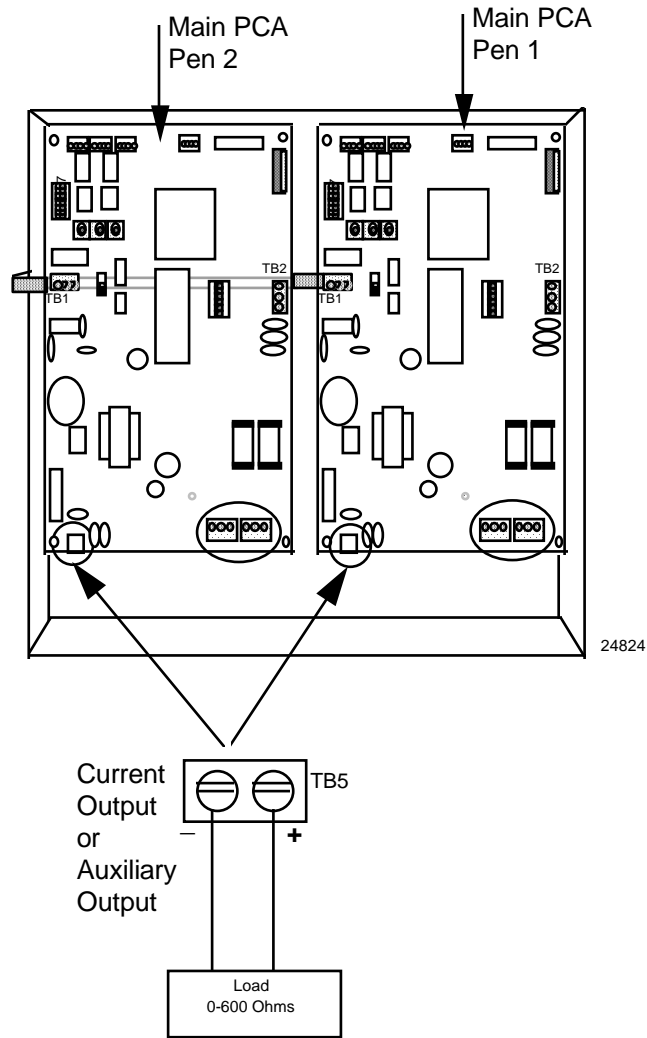

Figure 2-16 Current Output Wiring

2.6.3 Transmitter Power Out

Introduction

A recorder model is available that provides +24 Vdc power out to a transmitter.

Procedure

Refer to Figure 2-17 and follow the procedure in Table 2-15 to wire the transmitter power out.

Table 2-15 Transmitter Power Out Wiring

Step	Action
ATTENTION To avoid damaging the recorder, be sure that you install the power wires into the correct screw terminals as shown in Figure 2-9 and Figure 2-10.	
1	Turn off the power to the recorder.
2	Open the recorder door. Loosen the captive screw in the chart plate and swing the plate out.
3	Locate the DC OUT terminal block on the Transmitter Power Module, located above the printed circuit assembly (PCA) for pen 1. (See Figure 2-17.)
4	Run the output wires through the appropriate conduit hole (see Figure 2-7 and Figure 2-8). Refer to Table 2-6 for acceptable wire bundling.
5	Strip 1/4-inch maximum of insulation from the end of each wire and form end to fit under a screw connection.
6	Insert the wires under the appropriate screws for the transmitter power out as shown in the figure. Tighten the screws to secure the wires.

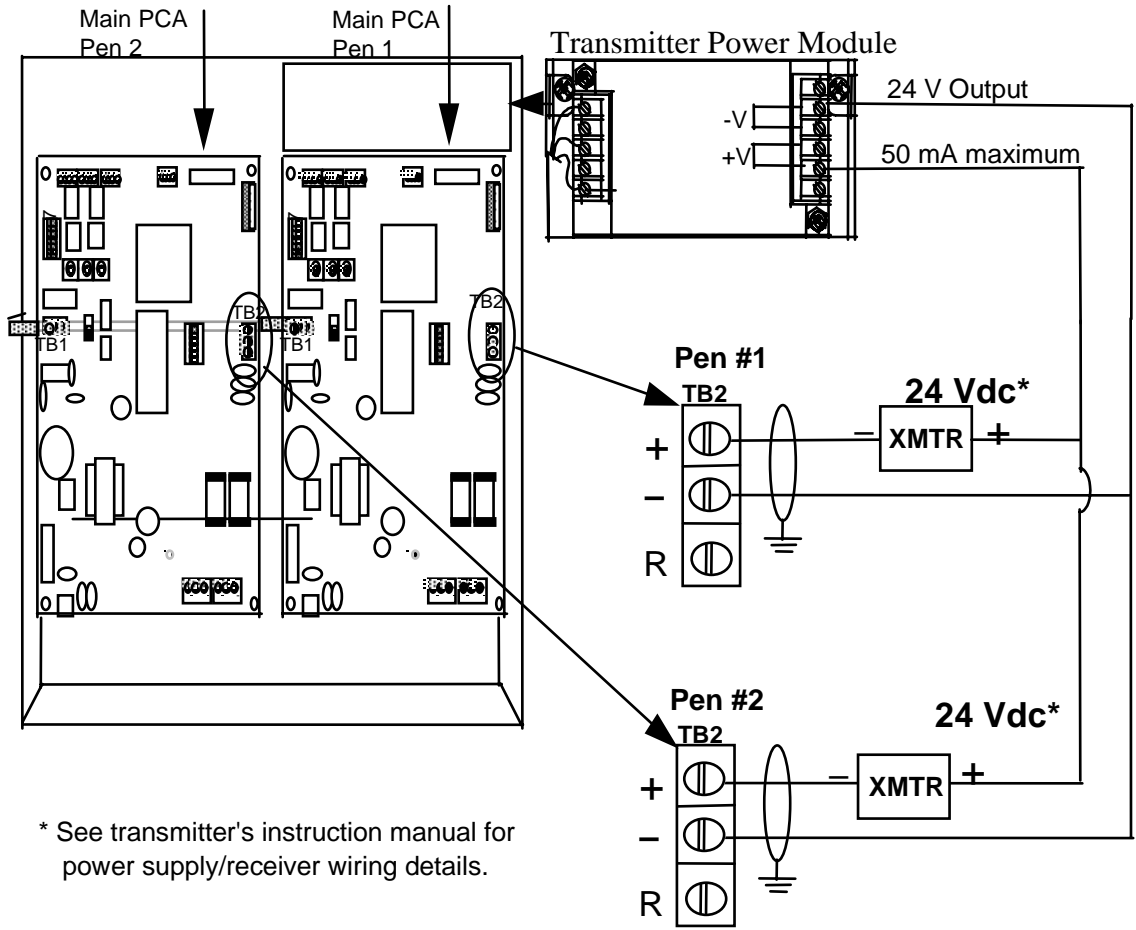

Figure 2-17 Transmitter Power Out Wiring

NOTE: Ensure switches on SW6 are set to their correct positions prior to applying power to transmitter supply.

For switch settings see Table 3-2 (recorders without display) or Table 4-3 (recorders with display).

3. Configuration, Startup, and Operation of Basic Recorder without Display

3.1 Overview

Introduction

Set up the functionality of the models that do not have a display and keypad using configuration and input switches. Each pen channel in the recorder has an associated printed circuit assembly (PCA) shown in Figure 3-1. The configuration switches are the SW1 switchbank. The input switches are the SW6 switchbank. If your recorder is equipped with two pens, the printed circuit assemblies for the two pens can be set up differently. The PCA for pen 1 (purple) is on the right (when facing the recorder); the PCA for pen 2 (red) is on the left (if present).

Set up is fast and easy. This section includes a table that shows the various available combinations of recording selections (such as chart range, length of time for single rotation of chart, whether the input is linear or non-linear), input actuation types, and whether jumper R56 should be in or out. Find your desired configuration for the pen 1 channel on the table, then set the SW1 and SW6 switches as indicated. Repeat the process for the pen 2 channel, if available on your recorder, and set up is complete.

What's in this section?

The following is a list of topics covered in this section.

Topic	See Page
3.1 Overview	45
3.2 Configuration (Recording Set Up)	46
3.3 Startup and Operation	65



WARNING—SHOCK HAZARD



SET THE SWITCHES DESCRIBED IN THIS SECTION WITH THE UNIT POWER DISCONNECTED. DO NOT TOUCH POWER CONNECTIONS AT TB1. FAILURE TO OBSERVE THIS PRECAUTION CAN RESULT IN EXPOSURE TO A POTENTIALLY LETHAL SHOCK HAZARD. MORE THAN ONE SWITCH MAY BE REQUIRED TO DE-ENERGIZE UNIT.

3.2 Configuration (Recording Set Up)

3.2.1 Setting Configuration and Input Switches

Introduction

Configuration switches SW1 (see Figure 3-1) and input switches SW6 are provided on each printed circuit assembly associated with a pen channel. If your recorder is equipped with two pens, the printed circuit assemblies for the two pens can be set up differently.

Table 3-2 shows the various available combinations of recording selections (such as chart range, length of time for single rotation of chart, whether input is linear or non-linear), input actuation types, and whether jumper R56 should be in or out.

Figure 3-2 shows a sample chart for a 1-pen recorder.

Procedure

Follow the procedure in Table 3-1 to set up your recorder model without display. (To set up a model with a display see *Section 4 – Configuration, Startup, and Operation of Recorder with Display.*)

The procedure described here assumes that the chart door is opened, the chart plate is swung out, and the power is removed.

WARNING



SHOCK HAZARD

When the unit is powered a potentially lethal shock hazard exists at the AC line connections at TB1 on each printed circuit assembly. Make sure the unit power is disconnected before starting the procedure. More than one switch may be required to de-energize the recorder.

Failure to observe this precaution can result in exposure to a potentially lethal shock hazard.

Table 3-1 Procedure for Configuring Model without Display

Step	Action
1	Turn off the power to the recorder.
2	Go to Table 3-2 and find the desired combination of recording selections and input type for the pen 1 channel.
3	Set the switches in SW1 and SW6 on the pen 1 printed circuit assembly (the PCA on the right when facing recorder) as indicated in Table 3-2. (Pen 1 is purple.)
4	Repeat for pen 2 channel (if available).
5	For each PCA, make a note of the number assigned to the configuration (from first column of Table 3-2). If you have to call Honeywell Technical Assistance for help, tell the support staff the configuration number(s) of the pen channel(s) in your recorder to speed up the troubleshooting process.
ATTENTION	
If you set the switches in an ON/OFF combination that does not match any of the configurations in Table 3-2, the recorder will use configuration #1.	

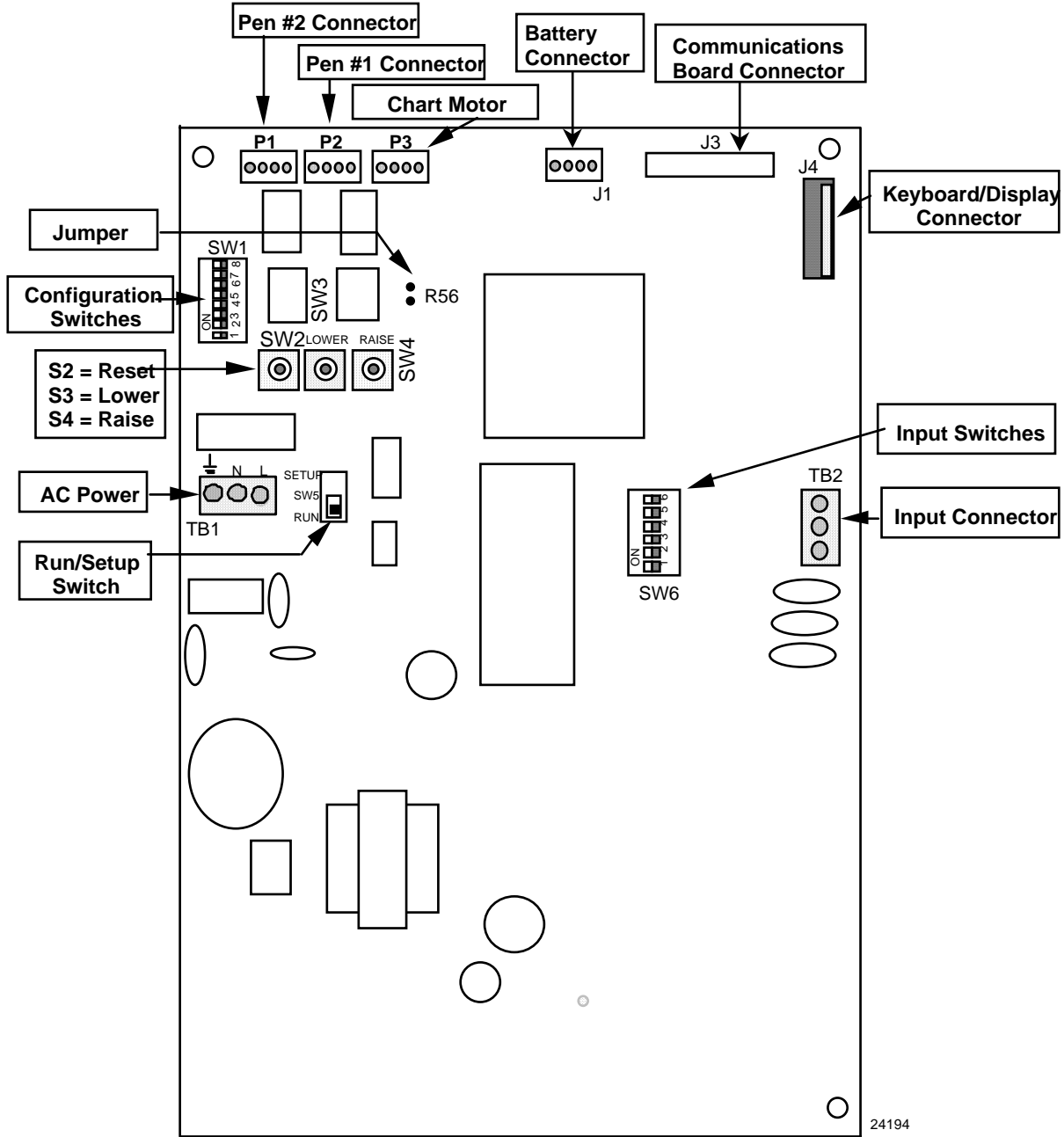

Figure 3-1 Location of Configuration and Input Switches

Configuration and Input switch settings for sample chart

Configuration Switch S1

1	2	3	4	5	6	7	8
on	off	off	on	on	off	off	off

Input Switch S6

1	2	3	4	5	6
off	X	off	off	on	off

X = Don't care

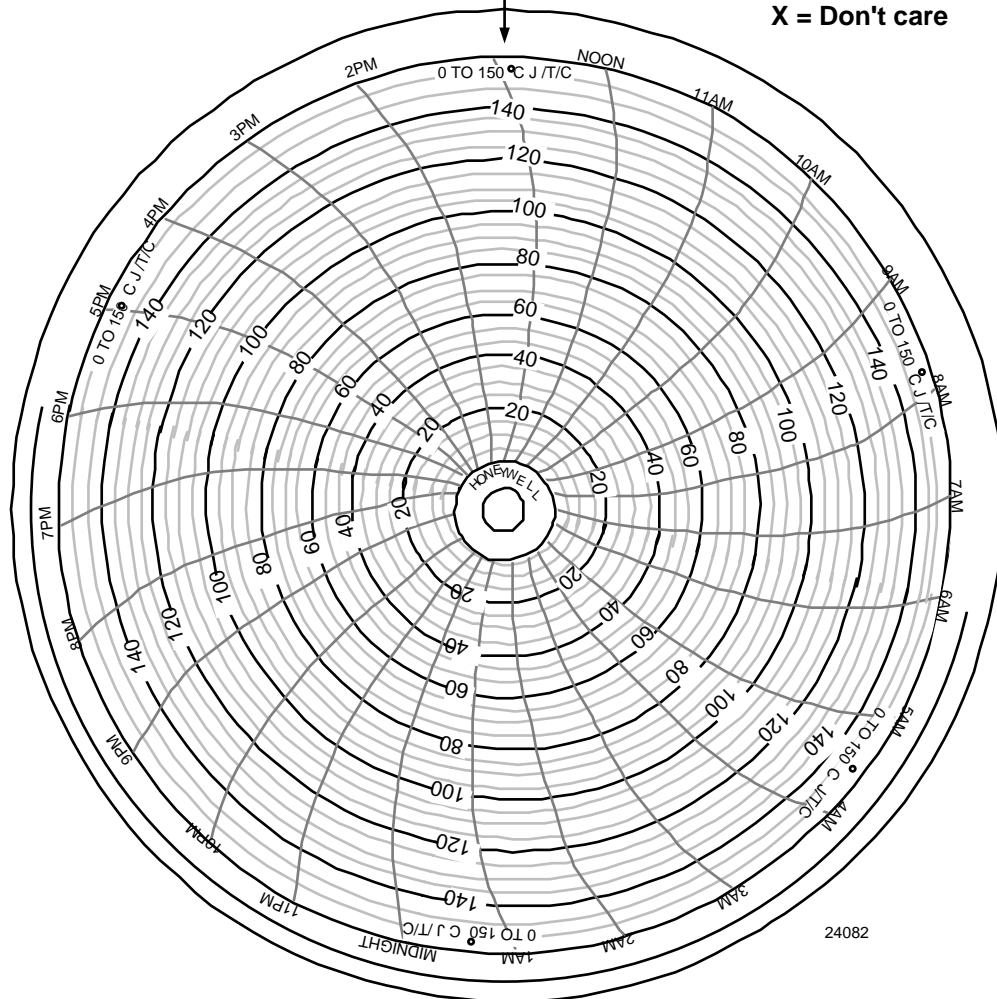



Summary of Input Set Up Switch S6 Functions

1	2	3	4	5	6
200 mV	Burnout	RTD	Volts	mV	mA

Figure 3-2 Sample Chart for Single Pen Recorder

Table 3-2 Configuration and Input Switch Settings for Models without Display

Input Type	Chart Type	Con-fig #	EU	Non-Lin	CONFIG SWITCHES (SW1)								INPUT SWITCHES (SW6)						Chart Part Number	R56 ***				
					1	2	3	4	5	6	7	8	1	2	3	4	5	6						
	Stored Configuration	0			<input type="checkbox"/>	<input type="checkbox"/>	<input type="checkbox"/>	<input type="checkbox"/>	<input type="checkbox"/>	<input type="checkbox"/>	<input type="checkbox"/>	<input type="checkbox"/>	<input type="checkbox"/>	<input type="checkbox"/>	<input type="checkbox"/>	<input type="checkbox"/>	<input type="checkbox"/>	<input type="checkbox"/>	<input type="checkbox"/>	<input type="checkbox"/>	<input type="checkbox"/>			in
		255			<input checked="" type="checkbox"/>	<input checked="" type="checkbox"/>	<input checked="" type="checkbox"/>	<input checked="" type="checkbox"/>	<input checked="" type="checkbox"/>	<input checked="" type="checkbox"/>	<input checked="" type="checkbox"/>	<input checked="" type="checkbox"/>	<input checked="" type="checkbox"/>	<input type="checkbox"/>	<input checked="" type="checkbox"/>	<input type="checkbox"/>	<input type="checkbox"/>	<input checked="" type="checkbox"/>	<input type="checkbox"/>	<input type="checkbox"/>	<input type="checkbox"/>			in
	Stored Configuration	256			<input type="checkbox"/>	<input type="checkbox"/>	<input type="checkbox"/>	<input type="checkbox"/>	<input type="checkbox"/>	<input type="checkbox"/>	<input type="checkbox"/>	<input type="checkbox"/>	<input type="checkbox"/>	<input type="checkbox"/>	<input type="checkbox"/>	<input type="checkbox"/>	<input type="checkbox"/>	<input type="checkbox"/>	<input type="checkbox"/>	<input type="checkbox"/>	<input type="checkbox"/>			out
0-1 Volt	Any linear chart 8 Hr	291			<input checked="" type="checkbox"/>	<input checked="" type="checkbox"/>	<input type="checkbox"/>	<input type="checkbox"/>	<input type="checkbox"/>	<input checked="" type="checkbox"/>	<input type="checkbox"/>	<input type="checkbox"/>	<input type="checkbox"/>	<input type="checkbox"/>	<input checked="" type="checkbox"/>	<input type="checkbox"/>	<input type="checkbox"/>	<input type="checkbox"/>	<input type="checkbox"/>	<input type="checkbox"/>	<input type="checkbox"/>			out
0-5 Volt	Any linear chart 8 Hr	288			<input type="checkbox"/>	<input type="checkbox"/>	<input type="checkbox"/>	<input type="checkbox"/>	<input type="checkbox"/>	<input checked="" type="checkbox"/>	<input type="checkbox"/>	<input type="checkbox"/>	<input type="checkbox"/>	<input type="checkbox"/>	<input checked="" type="checkbox"/>	<input type="checkbox"/>	<input checked="" type="checkbox"/>	<input type="checkbox"/>	<input type="checkbox"/>	<input type="checkbox"/>	<input type="checkbox"/>			out
0-10 Volt	Any linear chart 8 Hr	292			<input type="checkbox"/>	<input type="checkbox"/>	<input checked="" type="checkbox"/>	<input type="checkbox"/>	<input type="checkbox"/>	<input checked="" type="checkbox"/>	<input type="checkbox"/>	<input type="checkbox"/>	<input type="checkbox"/>	<input type="checkbox"/>	<input checked="" type="checkbox"/>	<input type="checkbox"/>	<input checked="" type="checkbox"/>	<input type="checkbox"/>	<input type="checkbox"/>	<input type="checkbox"/>	<input type="checkbox"/>			out
1-5 Volt	Any linear chart 8 Hr	289			<input checked="" type="checkbox"/>	<input type="checkbox"/>	<input type="checkbox"/>	<input type="checkbox"/>	<input type="checkbox"/>	<input checked="" type="checkbox"/>	<input type="checkbox"/>	<input type="checkbox"/>	<input type="checkbox"/>	<input type="checkbox"/>	<input checked="" type="checkbox"/>	<input type="checkbox"/>	<input checked="" type="checkbox"/>	<input type="checkbox"/>	<input type="checkbox"/>	<input type="checkbox"/>	<input type="checkbox"/>			out
2-10 Volt	Any linear chart 8 Hr	297			<input checked="" type="checkbox"/>	<input type="checkbox"/>	<input type="checkbox"/>	<input checked="" type="checkbox"/>	<input type="checkbox"/>	<input checked="" type="checkbox"/>	<input type="checkbox"/>	<input type="checkbox"/>	<input type="checkbox"/>	<input type="checkbox"/>	<input checked="" type="checkbox"/>	<input type="checkbox"/>	<input checked="" type="checkbox"/>	<input type="checkbox"/>	<input type="checkbox"/>	<input type="checkbox"/>	<input type="checkbox"/>			out
0-20 mA	Any linear chart 8 Hr	296			<input type="checkbox"/>	<input type="checkbox"/>	<input type="checkbox"/>	<input checked="" type="checkbox"/>	<input type="checkbox"/>	<input checked="" type="checkbox"/>	<input type="checkbox"/>	<input type="checkbox"/>	<input type="checkbox"/>	<input type="checkbox"/>	<input checked="" type="checkbox"/>	<input type="checkbox"/>	<input checked="" type="checkbox"/>	<input type="checkbox"/>	<input type="checkbox"/>	<input checked="" type="checkbox"/>	<input type="checkbox"/>			out
4-20 mA	Any linear chart 8 Hr	290			<input type="checkbox"/>	<input checked="" type="checkbox"/>	<input type="checkbox"/>	<input type="checkbox"/>	<input type="checkbox"/>	<input checked="" type="checkbox"/>	<input type="checkbox"/>	<input type="checkbox"/>	<input type="checkbox"/>	<input type="checkbox"/>	<input checked="" type="checkbox"/>	<input type="checkbox"/>	<input checked="" type="checkbox"/>	<input type="checkbox"/>	<input type="checkbox"/>	<input checked="" type="checkbox"/>	<input type="checkbox"/>			out
0-10 mV	Any linear chart 8 Hr	293			<input checked="" type="checkbox"/>	<input type="checkbox"/>	<input checked="" type="checkbox"/>	<input type="checkbox"/>	<input type="checkbox"/>	<input checked="" type="checkbox"/>	<input type="checkbox"/>	<input type="checkbox"/>	<input type="checkbox"/>	<input type="checkbox"/>	<input checked="" type="checkbox"/>	<input type="checkbox"/>	<input checked="" type="checkbox"/>	<input type="checkbox"/>	<input type="checkbox"/>	<input type="checkbox"/>	<input type="checkbox"/>			out
0-100 mV	Any linear chart 8 Hr	294			<input type="checkbox"/>	<input checked="" type="checkbox"/>	<input checked="" type="checkbox"/>	<input type="checkbox"/>	<input type="checkbox"/>	<input checked="" type="checkbox"/>	<input type="checkbox"/>	<input type="checkbox"/>	<input type="checkbox"/>	<input type="checkbox"/>	<input checked="" type="checkbox"/>	<input type="checkbox"/>	<input checked="" type="checkbox"/>	<input type="checkbox"/>	<input type="checkbox"/>	<input type="checkbox"/>	<input type="checkbox"/>			out
0-200 mV	Any linear chart 8 Hr	295			<input checked="" type="checkbox"/>	<input checked="" type="checkbox"/>	<input checked="" type="checkbox"/>	<input type="checkbox"/>	<input type="checkbox"/>	<input checked="" type="checkbox"/>	<input type="checkbox"/>	<input type="checkbox"/>	<input type="checkbox"/>	<input checked="" type="checkbox"/>	<input checked="" type="checkbox"/>	<input type="checkbox"/>	<input type="checkbox"/>	<input type="checkbox"/>	<input type="checkbox"/>	<input type="checkbox"/>	<input type="checkbox"/>			out
0-1 Volt	Any linear chart 12 Hr	301			<input checked="" type="checkbox"/>	<input type="checkbox"/>	<input checked="" type="checkbox"/>	<input checked="" type="checkbox"/>	<input type="checkbox"/>	<input checked="" type="checkbox"/>	<input type="checkbox"/>	<input type="checkbox"/>	<input type="checkbox"/>	<input type="checkbox"/>	<input checked="" type="checkbox"/>	<input type="checkbox"/>	<input checked="" type="checkbox"/>	<input type="checkbox"/>	<input type="checkbox"/>	<input type="checkbox"/>	<input type="checkbox"/>			out
0-5 Volt	Any linear chart 12 Hr	298			<input type="checkbox"/>	<input checked="" type="checkbox"/>	<input type="checkbox"/>	<input checked="" type="checkbox"/>	<input type="checkbox"/>	<input checked="" type="checkbox"/>	<input type="checkbox"/>	<input type="checkbox"/>	<input type="checkbox"/>	<input type="checkbox"/>	<input checked="" type="checkbox"/>	<input type="checkbox"/>	<input checked="" type="checkbox"/>	<input type="checkbox"/>	<input type="checkbox"/>	<input type="checkbox"/>	<input type="checkbox"/>			out
0-10 Volt	Any linear chart 12 Hr	302			<input type="checkbox"/>	<input checked="" type="checkbox"/>	<input checked="" type="checkbox"/>	<input checked="" type="checkbox"/>	<input type="checkbox"/>	<input checked="" type="checkbox"/>	<input type="checkbox"/>	<input type="checkbox"/>	<input type="checkbox"/>	<input type="checkbox"/>	<input checked="" type="checkbox"/>	<input type="checkbox"/>	<input checked="" type="checkbox"/>	<input type="checkbox"/>	<input type="checkbox"/>	<input type="checkbox"/>	<input type="checkbox"/>			out
1-5 Volt	Any linear chart 12 Hr	299			<input checked="" type="checkbox"/>	<input checked="" type="checkbox"/>	<input type="checkbox"/>	<input checked="" type="checkbox"/>	<input type="checkbox"/>	<input checked="" type="checkbox"/>	<input type="checkbox"/>	<input type="checkbox"/>	<input type="checkbox"/>	<input type="checkbox"/>	<input checked="" type="checkbox"/>	<input type="checkbox"/>	<input checked="" type="checkbox"/>	<input type="checkbox"/>	<input type="checkbox"/>	<input type="checkbox"/>	<input type="checkbox"/>			out
2-10 Volt	Any linear chart 12 Hr	307			<input checked="" type="checkbox"/>	<input checked="" type="checkbox"/>	<input type="checkbox"/>	<input type="checkbox"/>	<input checked="" type="checkbox"/>	<input checked="" type="checkbox"/>	<input type="checkbox"/>	<input type="checkbox"/>	<input type="checkbox"/>	<input type="checkbox"/>	<input checked="" type="checkbox"/>	<input type="checkbox"/>	<input checked="" type="checkbox"/>	<input type="checkbox"/>	<input type="checkbox"/>	<input type="checkbox"/>	<input type="checkbox"/>			out
0-20 mA	Any linear chart 12 Hr	306			<input type="checkbox"/>	<input checked="" type="checkbox"/>	<input type="checkbox"/>	<input type="checkbox"/>	<input checked="" type="checkbox"/>	<input checked="" type="checkbox"/>	<input type="checkbox"/>	<input type="checkbox"/>	<input type="checkbox"/>	<input type="checkbox"/>	<input checked="" type="checkbox"/>	<input type="checkbox"/>	<input checked="" type="checkbox"/>	<input type="checkbox"/>	<input type="checkbox"/>	<input checked="" type="checkbox"/>	<input type="checkbox"/>			out

		<div style="display: flex; justify-content: space-between; align-items: center;"> <div style="text-align: center;">  <p>CONFIG SWITCHES</p> </div> <div style="text-align: center;"> <p>□ = off ■ = on</p> <p>Any RTD marked with an asterisk is IEC Alpha = 0.00391</p> <p>All other RTDs are IEC Alpha = 0.00385</p> <p>☒ in column for SW6 switch 2 = see Subsection 3.2.2</p> </div> <div style="text-align: center;">  <p>INPUT SWITCHES</p> </div> </div>																		
Input Type	Chart Type	Con-fig #	EU	Non-Lin	CONFIG Switches (SW1)								INPUT Switches (SW6)						Chart Part Number	R56 ***
					1	2	3	4	5	6	7	8	1	2	3	4	5	6		
4-20 mA	Any linear chart 12 Hr	300			□	□	■	■	□	■	□	□	□	☒	□	■	□	■		out
0-10 mV	Any linear chart 12 Hr	303			■	■	■	■	□	■	□	□	□	☒	□	□	■	□		out
0-100 mV	Any linear chart 12 Hr	304			□	□	□	□	■	■	□	□	□	☒	□	□	■	□		out
0-200 mV	Any linear chart 12 Hr	305			■	□	□	□	■	■	□	□	■	☒	□	□	□	□		out
0-1 Volt	Any linear chart 24 Hr	4			□	□	■	□	□	□	□	□	□	☒	□	■	□	□	24001660-tab	in
0-5 Volt	Any linear chart 24 Hr <i>(default setting)</i>	1**			■	□	□	□	□	□	□	□	□	☒	□	■	□	□	24001660-tab	in
0-10 Volt	Any linear chart 24 Hr	5			■	□	■	□	□	□	□	□	□	☒	□	■	□	□	24001660-tab	in
1-5 Volt	Any linear chart 24 Hr	2			□	■	□	□	□	□	□	□	□	☒	□	■	□	□	24001660-tab	in
2-10 Volt	Any linear chart 24 Hr	200			□	□	□	■	□	□	■	■	□	☒	□	■	□	□	24001660-tab	in
0-20 mA	Any linear chart 24 Hr	9			■	□	□	■	□	□	□	□	□	☒	□	■	□	■	24001660-tab	in
4-20 mA	Any linear chart 24 Hr	3			■	■	□	□	□	□	□	□	□	☒	□	■	□	■	24001660-tab	in
0-10 mV	Any linear chart 24 Hr	6			□	■	■	□	□	□	□	□	□	☒	□	□	■	□	24001660-tab	in
0-100 mV	Any linear chart 24 Hr	7			■	■	■	□	□	□	□	□	□	☒	□	□	■	□	24001660-tab	in
0-200 mV	Any linear chart 24 Hr	8			□	□	□	■	□	□	□	□	■	☒	□	□	□	□	24001660-tab	in
0-1 Volt	Any linear chart 7 Day	13			■	□	■	■	□	□	□	□	□	☒	□	■	□	□	24001661-tab	in
0-5 Volt	Any linear chart 7 Day	10			□	■	□	■	□	□	□	□	□	☒	□	■	□	□	24001661-tab	in
0-10 Volt	Any linear chart 7 Day	14			□	■	■	■	□	□	□	□	□	☒	□	■	□	□	24001661-tab	in
1-5 Volt	Any linear chart 7 Day	11			■	■	□	■	□	□	□	□	□	☒	□	■	□	□	24001661-tab	in

Input Type	Chart Type	Con-fig #	EU	Non-Lin	CONFIG SWITCHES (SW1)								INPUT SWITCHES (SW6)						Chart Part Number	R56 ***
					1	2	3	4	5	6	7	8	1	2	3	4	5	6		
2-10 Volt	Any linear chart 7 Day	201			■	□	□	■	□	□	■	■	□	☒	□	■	□	□	24001661-tab	in
0-20 mA	Any linear chart 7 Day	18			□	■	□	□	■	□	□	□	□	☒	□	■	□	■	24001661-tab	in
4-20 mA	Any linear chart 7 Day	12			□	□	■	■	□	□	□	□	□	☒	□	■	□	■	24001661-tab	in
0-10 mV	Any linear chart 7 Day	15			■	■	■	■	□	□	□	□	□	☒	□	□	■	□	24001661-tab	in
0-100 mV	Any linear chart 7 Day	16			□	□	□	□	■	□	□	□	□	☒	□	□	■	□	24001661-tab	in
0-200 mV	Any linear chart 7 Day	17			■	□	□	□	■	□	□	□	■	☒	□	□	□	□	24001661-tab	in
B t/c	0 to 1800 °C 24 Hr	78		x	□	■	■	■	□	□	■	□	□	☒	□	□	■	□	1660-135	in
E t/c	0 to 250 °C 24 Hr	41		x	■	□	□	■	□	■	□	□	□	☒	□	□	■	□		in
J t/c	0 to 100 Even 24 hr	197	°F		■	□	■	□	□	□	■	■	□	☒	□	□	■	□	1660-001	in
J t/c	0 to 100 Even 7 Day	198	°F		□	■	■	□	□	□	■	■	□	☒	□	□	■	□	1661-001	in
J t/c	0 to 100 Even 24 hr	230	°C		□	■	■	□	□	■	■	■	□	☒	□	□	■	□	1660-001	in
J t/c	0 to 100 Even 7 Day	231	°C		■	■	■	□	□	■	■	■	□	☒	□	□	■	□	1661-001	in
J t/c	-45 to 150 °C 24 Hr	108		x	□	□	■	■	□	■	■	□	□	☒	□	□	■	□	1660-027	in
J t/c	-45 to 150 °C 7 Day	109		x	□	□	■	■	□	■	■	□	□	☒	□	□	■	□	1661-027	in
J t/c	0 to 150 °C 24 Hr	25		x	■	□	□	■	■	□	□	□	□	☒	□	□	■	□	1660-070	in
J t/c	0 to 150 °C 7 Day	26		x	□	■	□	■	■	□	□	□	□	☒	□	□	■	□	1661-070	in
J t/c	0 to 150 Even 24 Hr	232	°F		□	□	□	■	□	■	■	■	□	☒	□	□	■	□	1660-180	in
J t/c	0 to 150 Even 7 Day	233	°F		■	□	□	■	□	■	■	■	□	☒	□	□	■	□		in
J t/c	0 to 200 °F 24 Hr	35		x	■	■	□	□	□	■	□	□	□	☒	□	□	■	□	1660-114	in
J t/c	0 to 200 Even 24 Hr	129	°F		■	□	□	□	□	□	□	■	□	☒	□	□	■	□	1660-010	in
J t/c	0 to 200 Even 24 Hr	132	°C		□	□	■	□	□	□	□	■	□	☒	□	□	■	□	1660-010	in

Input Type	Chart Type	Con-fig #	EU	Non-Lin	CONFIG SWITCHES (SW1)								INPUT SWITCHES (SW6)						Chart Part Number	R56 ***
					1	2	3	4	5	6	7	8	1	2	3	4	5	6		
J t/c	0 to 200 Even 7 Day	135	°F		■	■	■	□	□	□	□	■	□	☒	□	□	■	□	1661-004	in
J t/c	0 to 200 Even 7 Day	138	°C		□	■	□	■	□	□	□	■	□	☒	□	□	■	□	1661-004	in
J t/c	0 to 250 °C 24 Hr	39		x	■	■	■	□	□	■	□	□	□	☒	□	□	■	□	1660-024	in
J t/c	0 to 250 °C 7 Day	40		x	□	□	□	■	□	■	□	□	□	☒	□	□	■	□	1661-024	in
J t/c	50 to 250 Even 24 Hr	214	°F		□	■	■	□	■	□	■	■	□	☒	□	□	■	□	1660-008	in
J t/c	-50 to 300 °F 24 Hr	257		x	■	□	□	□	□	□	□	□	□	☒	□	□	■	□	1660-019	out
J t/c	-50 to 300 °F 7 Day	258		x	□	■	□	□	□	□	□	□	□	☒	□	□	■	□	1661-019	out
J t/c	0 to 300 °C 24 Hr	44		x	□	□	■	■	□	■	□	□	□	☒	□	□	■	□	1660-062	in
J t/c	0 to 300 °F 24 Hr	45		x	■	□	■	■	□	■	□	□	□	☒	□	□	■	□	1660-002	in
J t/c	0 to 300 °F 7 Day	90		x	□	■	□	■	■	□	■	□	□	☒	□	□	■	□	1661-002	in
J t/c	0 to 300 Even 24 Hr	143	°F		■	■	■	■	□	□	□	■	□	☒	□	□	■	□	1660-050	in
J t/c	0 to 300 Even 7 Day	215	°F		■	■	■	□	■	□	■	■	□	☒	□	□	■	□	1661-050	in
J t/c	0 to 300 Even 7 Day	216	°C		□	□	□	■	■	□	■	■	□	☒	□	□	■	□	1661-050	in
J t/c	0 to 300 °C 7 Day	287		x	■	■	■	■	■	□	□	□	□	☒	□	□	■	□	1661-062	out
J t/c	10 to 340 °C 24 Hr	46		x	□	■	■	■	□	■	□	□	□	☒	□	□	■	□	1660-057	in
J t/c	10 to 340 °C 7 Day	47		x	■	■	■	■	□	■	□	□	□	☒	□	□	■	□	1661-057	in
J t/c	0 to 350 Even 24 Hr	148	°C		□	□	■	□	■	□	□	■	□	☒	□	□	■	□	1660-037	in
J t/c	0 to 350 Even 7 Day	149	°F		■	□	■	□	■	□	□	■	□	☒	□	□	■	□	1660-037	in
J t/c	0 to 350 Even 24 Hr	217	°F		■	□	□	■	■	□	■	■	□	☒	□	□	■	□	1660-037	in
J t/c	0 to 350 Even 7 Day	219	°C		■	■	□	■	■	□	■	■	□	☒	□	□	■	□	1660-037	in
J t/c	0 to 400 °F 24 Hr	48		x	□	□	□	□	■	■	□	□	□	☒	□	□	■	□	1660-012	in
J t/c	0 to 400 °C 24 Hr	50		x	□	■	□	□	■	■	□	□	□	☒	□	□	■	□	1660-063	in

Input Type	Chart Type	Con-fig #	EU	Non-Lin	CONFIG SWITCHES (SW1)								INPUT SWITCHES (SW6)						Chart Part Number	R56 ***
					1	2	3	4	5	6	7	8	1	2	3	4	5	6		
J t/c	0 to 400 Even 24 Hr	152	°F		<input type="checkbox"/>	<input type="checkbox"/>	<input type="checkbox"/>	<input checked="" type="checkbox"/>	<input checked="" type="checkbox"/>	<input type="checkbox"/>	<input type="checkbox"/>	<input checked="" type="checkbox"/>	<input type="checkbox"/>	<input checked="" type="checkbox"/>	<input type="checkbox"/>	<input type="checkbox"/>	<input checked="" type="checkbox"/>	<input type="checkbox"/>	1660-011	in
J t/c	0 to 400 Even 24 Hr	155	°C		<input checked="" type="checkbox"/>	<input checked="" type="checkbox"/>	<input type="checkbox"/>	<input checked="" type="checkbox"/>	<input checked="" type="checkbox"/>	<input type="checkbox"/>	<input type="checkbox"/>	<input checked="" type="checkbox"/>	<input type="checkbox"/>	<input checked="" type="checkbox"/>	<input type="checkbox"/>	<input type="checkbox"/>	<input checked="" type="checkbox"/>	<input type="checkbox"/>	1660-011	in
J t/c	0 to 400 Even 7 Day	158	°F		<input type="checkbox"/>	<input checked="" type="checkbox"/>	<input checked="" type="checkbox"/>	<input checked="" type="checkbox"/>	<input checked="" type="checkbox"/>	<input type="checkbox"/>	<input type="checkbox"/>	<input checked="" type="checkbox"/>	<input type="checkbox"/>	<input checked="" type="checkbox"/>	<input type="checkbox"/>	<input type="checkbox"/>	<input checked="" type="checkbox"/>	<input type="checkbox"/>	1661-005	in
J t/c	0 to 400 Even 7 Day	161	°C		<input checked="" type="checkbox"/>	<input type="checkbox"/>	<input type="checkbox"/>	<input type="checkbox"/>	<input type="checkbox"/>	<input checked="" type="checkbox"/>	<input type="checkbox"/>	<input checked="" type="checkbox"/>	<input type="checkbox"/>	<input checked="" type="checkbox"/>	<input type="checkbox"/>	<input type="checkbox"/>	<input checked="" type="checkbox"/>	<input type="checkbox"/>	1661-005	in
J t/c	0 to 400 °F 8 Hr	286		x	<input type="checkbox"/>	<input checked="" type="checkbox"/>	<input checked="" type="checkbox"/>	<input checked="" type="checkbox"/>	<input checked="" type="checkbox"/>	<input type="checkbox"/>	<input type="checkbox"/>	<input type="checkbox"/>	<input type="checkbox"/>	<input checked="" type="checkbox"/>	<input type="checkbox"/>	<input type="checkbox"/>	<input checked="" type="checkbox"/>	<input type="checkbox"/>	1902-001	out
J t/c	0 to 500 °F 24 Hr	54		x	<input type="checkbox"/>	<input checked="" type="checkbox"/>	<input checked="" type="checkbox"/>	<input type="checkbox"/>	<input checked="" type="checkbox"/>	<input checked="" type="checkbox"/>	<input type="checkbox"/>	<input type="checkbox"/>	<input type="checkbox"/>	<input checked="" type="checkbox"/>	<input type="checkbox"/>	<input type="checkbox"/>	<input checked="" type="checkbox"/>	<input type="checkbox"/>	1660-013	in
J t/c	0 to 500 °F 7 Day	95		x	<input checked="" type="checkbox"/>	<input checked="" type="checkbox"/>	<input checked="" type="checkbox"/>	<input checked="" type="checkbox"/>	<input checked="" type="checkbox"/>	<input type="checkbox"/>	<input checked="" type="checkbox"/>	<input type="checkbox"/>	<input type="checkbox"/>	<input checked="" type="checkbox"/>	<input type="checkbox"/>	<input type="checkbox"/>	<input checked="" type="checkbox"/>	<input type="checkbox"/>	1661-007	in
J t/c	0 to 600 °F 24 Hr	56		x	<input type="checkbox"/>	<input type="checkbox"/>	<input type="checkbox"/>	<input checked="" type="checkbox"/>	<input checked="" type="checkbox"/>	<input checked="" type="checkbox"/>	<input type="checkbox"/>	<input type="checkbox"/>	<input type="checkbox"/>	<input checked="" type="checkbox"/>	<input type="checkbox"/>	<input type="checkbox"/>	<input checked="" type="checkbox"/>	<input type="checkbox"/>	1660-003	in
J t/c	0 to 600 °F 7 Day	57		x	<input checked="" type="checkbox"/>	<input type="checkbox"/>	<input type="checkbox"/>	<input checked="" type="checkbox"/>	<input checked="" type="checkbox"/>	<input checked="" type="checkbox"/>	<input type="checkbox"/>	<input type="checkbox"/>	<input type="checkbox"/>	<input checked="" type="checkbox"/>	<input type="checkbox"/>	<input type="checkbox"/>	<input checked="" type="checkbox"/>	<input type="checkbox"/>	1661-003	in
J t/c	0 to 600 Even 24 Hr	166	°F		<input type="checkbox"/>	<input checked="" type="checkbox"/>	<input checked="" type="checkbox"/>	<input type="checkbox"/>	<input type="checkbox"/>	<input checked="" type="checkbox"/>	<input type="checkbox"/>	<input checked="" type="checkbox"/>	<input type="checkbox"/>	<input checked="" type="checkbox"/>	<input type="checkbox"/>	<input type="checkbox"/>	<input checked="" type="checkbox"/>	<input type="checkbox"/>	1660-052	in
J t/c	0 to 600 Even 24 Hr	167	°C		<input checked="" type="checkbox"/>	<input checked="" type="checkbox"/>	<input checked="" type="checkbox"/>	<input type="checkbox"/>	<input type="checkbox"/>	<input checked="" type="checkbox"/>	<input type="checkbox"/>	<input checked="" type="checkbox"/>	<input type="checkbox"/>	<input checked="" type="checkbox"/>	<input type="checkbox"/>	<input type="checkbox"/>	<input checked="" type="checkbox"/>	<input type="checkbox"/>	1660-052	in
J t/c	0 to 600 Even 7 Day	234	°F		<input type="checkbox"/>	<input checked="" type="checkbox"/>	<input type="checkbox"/>	<input checked="" type="checkbox"/>	<input type="checkbox"/>	<input checked="" type="checkbox"/>	<input checked="" type="checkbox"/>	<input checked="" type="checkbox"/>	<input type="checkbox"/>	<input checked="" type="checkbox"/>	<input type="checkbox"/>	<input type="checkbox"/>	<input checked="" type="checkbox"/>	<input type="checkbox"/>	1661-008	in
J t/c	50 to 650 °F 24 Hr	100		x	<input type="checkbox"/>	<input type="checkbox"/>	<input checked="" type="checkbox"/>	<input type="checkbox"/>	<input type="checkbox"/>	<input checked="" type="checkbox"/>	<input checked="" type="checkbox"/>	<input type="checkbox"/>	<input type="checkbox"/>	<input checked="" type="checkbox"/>	<input type="checkbox"/>	<input type="checkbox"/>	<input checked="" type="checkbox"/>	<input type="checkbox"/>	1660-056	in
J t/c	50 to 650 °F 7 Day	101		x	<input checked="" type="checkbox"/>	<input type="checkbox"/>	<input checked="" type="checkbox"/>	<input type="checkbox"/>	<input type="checkbox"/>	<input checked="" type="checkbox"/>	<input checked="" type="checkbox"/>	<input type="checkbox"/>	<input type="checkbox"/>	<input checked="" type="checkbox"/>	<input type="checkbox"/>	<input type="checkbox"/>	<input checked="" type="checkbox"/>	<input type="checkbox"/>	1661-056	in
J t/c	150 to 750 °F 7 Day	102		x	<input type="checkbox"/>	<input checked="" type="checkbox"/>	<input checked="" type="checkbox"/>	<input type="checkbox"/>	<input type="checkbox"/>	<input checked="" type="checkbox"/>	<input checked="" type="checkbox"/>	<input type="checkbox"/>	<input type="checkbox"/>	<input checked="" type="checkbox"/>	<input type="checkbox"/>	<input type="checkbox"/>	<input checked="" type="checkbox"/>	<input type="checkbox"/>	1661-150	in
J t/c	10 to 760 °C 24 Hr	103		x	<input checked="" type="checkbox"/>	<input checked="" type="checkbox"/>	<input checked="" type="checkbox"/>	<input type="checkbox"/>	<input type="checkbox"/>	<input checked="" type="checkbox"/>	<input checked="" type="checkbox"/>	<input type="checkbox"/>	<input type="checkbox"/>	<input checked="" type="checkbox"/>	<input type="checkbox"/>	<input type="checkbox"/>	<input checked="" type="checkbox"/>	<input type="checkbox"/>	1660-030	in
J t/c	10 to 760 °C 7 Day	104		x	<input type="checkbox"/>	<input type="checkbox"/>	<input type="checkbox"/>	<input checked="" type="checkbox"/>	<input type="checkbox"/>	<input checked="" type="checkbox"/>	<input checked="" type="checkbox"/>	<input type="checkbox"/>	<input type="checkbox"/>	<input checked="" type="checkbox"/>	<input type="checkbox"/>	<input type="checkbox"/>	<input checked="" type="checkbox"/>	<input type="checkbox"/>	1661-030	in
J t/c	0 to 800 °F 24 Hr	59		x	<input checked="" type="checkbox"/>	<input checked="" type="checkbox"/>	<input type="checkbox"/>	<input checked="" type="checkbox"/>	<input checked="" type="checkbox"/>	<input checked="" type="checkbox"/>	<input type="checkbox"/>	<input type="checkbox"/>	<input type="checkbox"/>	<input checked="" type="checkbox"/>	<input type="checkbox"/>	<input type="checkbox"/>	<input checked="" type="checkbox"/>	<input type="checkbox"/>	1660-014	in
J t/c	0 to 800 °F 7 Day	60		x	<input type="checkbox"/>	<input type="checkbox"/>	<input checked="" type="checkbox"/>	<input checked="" type="checkbox"/>	<input checked="" type="checkbox"/>	<input checked="" type="checkbox"/>	<input type="checkbox"/>	<input type="checkbox"/>	<input type="checkbox"/>	<input checked="" type="checkbox"/>	<input type="checkbox"/>	<input type="checkbox"/>	<input checked="" type="checkbox"/>	<input type="checkbox"/>	1661-009	in
J t/c	0 to 800 Even 24 Hr	169	°F		<input checked="" type="checkbox"/>	<input type="checkbox"/>	<input type="checkbox"/>	<input checked="" type="checkbox"/>	<input type="checkbox"/>	<input checked="" type="checkbox"/>	<input type="checkbox"/>	<input checked="" type="checkbox"/>	<input type="checkbox"/>	<input checked="" type="checkbox"/>	<input type="checkbox"/>	<input type="checkbox"/>	<input checked="" type="checkbox"/>	<input type="checkbox"/>	1660-137	in
J t/c	0 to 800 Even 24 Hr	170	°C		<input type="checkbox"/>	<input checked="" type="checkbox"/>	<input type="checkbox"/>	<input checked="" type="checkbox"/>	<input type="checkbox"/>	<input checked="" type="checkbox"/>	<input type="checkbox"/>	<input checked="" type="checkbox"/>	<input type="checkbox"/>	<input checked="" type="checkbox"/>	<input type="checkbox"/>	<input type="checkbox"/>	<input checked="" type="checkbox"/>	<input type="checkbox"/>	1660-137	in
J t/c	0 to 1000 °F 24 Hr	63		x	<input checked="" type="checkbox"/>	<input checked="" type="checkbox"/>	<input checked="" type="checkbox"/>	<input checked="" type="checkbox"/>	<input checked="" type="checkbox"/>	<input checked="" type="checkbox"/>	<input type="checkbox"/>	<input type="checkbox"/>	<input type="checkbox"/>	<input checked="" type="checkbox"/>	<input type="checkbox"/>	<input type="checkbox"/>	<input checked="" type="checkbox"/>	<input type="checkbox"/>	1660-015	in

Input Type	Chart Type	Con-fig #	EU	Non-Lin	CONFIG SWITCHES (SW1)								INPUT SWITCHES (SW6)						Chart Part Number	R56 ***
					1	2	3	4	5	6	7	8	1	2	3	4	5	6		
J t/c	0 to 1000 °F 7 Day	64		x	<input type="checkbox"/>	<input type="checkbox"/>	<input type="checkbox"/>	<input type="checkbox"/>	<input type="checkbox"/>	<input type="checkbox"/>	<input checked="" type="checkbox"/>	<input type="checkbox"/>	<input checked="" type="checkbox"/>	<input type="checkbox"/>	<input type="checkbox"/>	<input checked="" type="checkbox"/>	<input type="checkbox"/>	1661-010	in	
J t/c	0 to 1200 °F 24 Hr	67		x	<input checked="" type="checkbox"/>	<input checked="" type="checkbox"/>	<input type="checkbox"/>	<input type="checkbox"/>	<input type="checkbox"/>	<input type="checkbox"/>	<input checked="" type="checkbox"/>	<input type="checkbox"/>	<input checked="" type="checkbox"/>	<input type="checkbox"/>	<input type="checkbox"/>	<input checked="" type="checkbox"/>	<input type="checkbox"/>	1660-004	in	
J t/c	0 to 1200 °F 7 Day	70		x	<input type="checkbox"/>	<input checked="" type="checkbox"/>	<input checked="" type="checkbox"/>	<input type="checkbox"/>	<input type="checkbox"/>	<input type="checkbox"/>	<input checked="" type="checkbox"/>	<input type="checkbox"/>	<input checked="" type="checkbox"/>	<input type="checkbox"/>	<input type="checkbox"/>	<input checked="" type="checkbox"/>	<input type="checkbox"/>	1661-011	in	
J t/c	0 to 1200 Even 7 Day	178	°F		<input type="checkbox"/>	<input checked="" type="checkbox"/>	<input type="checkbox"/>	<input type="checkbox"/>	<input checked="" type="checkbox"/>	<input checked="" type="checkbox"/>	<input type="checkbox"/>	<input checked="" type="checkbox"/>	<input type="checkbox"/>	<input checked="" type="checkbox"/>	<input type="checkbox"/>	<input checked="" type="checkbox"/>	<input type="checkbox"/>	1661-108	in	
J t/c	0 to 1600 °F 24 Hr	72		x	<input type="checkbox"/>	<input type="checkbox"/>	<input type="checkbox"/>	<input checked="" type="checkbox"/>	<input type="checkbox"/>	<input type="checkbox"/>	<input checked="" type="checkbox"/>	<input type="checkbox"/>	<input checked="" type="checkbox"/>	<input type="checkbox"/>	<input type="checkbox"/>	<input checked="" type="checkbox"/>	<input type="checkbox"/>	1660-018	in	
J t/c	0 to 1600 °F 7 Day	92		x	<input type="checkbox"/>	<input type="checkbox"/>	<input checked="" type="checkbox"/>	<input checked="" type="checkbox"/>	<input checked="" type="checkbox"/>	<input type="checkbox"/>	<input checked="" type="checkbox"/>	<input type="checkbox"/>	<input checked="" type="checkbox"/>	<input type="checkbox"/>	<input type="checkbox"/>	<input checked="" type="checkbox"/>	<input type="checkbox"/>	1661-018	in	
J t/c	0 to 1600 Even 7 Day	179	°F		<input checked="" type="checkbox"/>	<input checked="" type="checkbox"/>	<input type="checkbox"/>	<input type="checkbox"/>	<input checked="" type="checkbox"/>	<input checked="" type="checkbox"/>	<input type="checkbox"/>	<input checked="" type="checkbox"/>	<input type="checkbox"/>	<input checked="" type="checkbox"/>	<input type="checkbox"/>	<input checked="" type="checkbox"/>	<input type="checkbox"/>	1661-109	in	
K t/c	-100 to 100 Even 24 Hr	226	°F		<input type="checkbox"/>	<input checked="" type="checkbox"/>	<input type="checkbox"/>	<input type="checkbox"/>	<input type="checkbox"/>	<input checked="" type="checkbox"/>	<input checked="" type="checkbox"/>	<input checked="" type="checkbox"/>	<input type="checkbox"/>	<input checked="" type="checkbox"/>	<input type="checkbox"/>	<input checked="" type="checkbox"/>	<input type="checkbox"/>	1660-201	in	
K t/c	-100 to 100 Even 24 Hr	227	°C		<input checked="" type="checkbox"/>	<input checked="" type="checkbox"/>	<input type="checkbox"/>	<input type="checkbox"/>	<input type="checkbox"/>	<input checked="" type="checkbox"/>	<input checked="" type="checkbox"/>	<input checked="" type="checkbox"/>	<input type="checkbox"/>	<input checked="" type="checkbox"/>	<input type="checkbox"/>	<input checked="" type="checkbox"/>	<input type="checkbox"/>	1660-201	in	
K t/c	-100 to 200 Even 24 Hr	220	°C		<input type="checkbox"/>	<input type="checkbox"/>	<input checked="" type="checkbox"/>	<input checked="" type="checkbox"/>	<input checked="" type="checkbox"/>	<input type="checkbox"/>	<input checked="" type="checkbox"/>	<input checked="" type="checkbox"/>	<input type="checkbox"/>	<input checked="" type="checkbox"/>	<input type="checkbox"/>	<input checked="" type="checkbox"/>	<input type="checkbox"/>	1660-232	in	
K t/c	-100 to 200 Even 7 Day	221	°C		<input checked="" type="checkbox"/>	<input type="checkbox"/>	<input checked="" type="checkbox"/>	<input checked="" type="checkbox"/>	<input checked="" type="checkbox"/>	<input type="checkbox"/>	<input checked="" type="checkbox"/>	<input checked="" type="checkbox"/>	<input type="checkbox"/>	<input checked="" type="checkbox"/>	<input type="checkbox"/>	<input checked="" type="checkbox"/>	<input type="checkbox"/>	1661-178	in	
K t/c	-100 to 200 Even 24 Hr	222	°F		<input type="checkbox"/>	<input checked="" type="checkbox"/>	<input checked="" type="checkbox"/>	<input checked="" type="checkbox"/>	<input checked="" type="checkbox"/>	<input type="checkbox"/>	<input checked="" type="checkbox"/>	<input checked="" type="checkbox"/>	<input type="checkbox"/>	<input checked="" type="checkbox"/>	<input type="checkbox"/>	<input checked="" type="checkbox"/>	<input type="checkbox"/>	1660-232	in	
K t/c	-100 to 200 Even 7 Day	223	°F		<input checked="" type="checkbox"/>	<input checked="" type="checkbox"/>	<input checked="" type="checkbox"/>	<input checked="" type="checkbox"/>	<input checked="" type="checkbox"/>	<input type="checkbox"/>	<input checked="" type="checkbox"/>	<input checked="" type="checkbox"/>	<input type="checkbox"/>	<input checked="" type="checkbox"/>	<input type="checkbox"/>	<input checked="" type="checkbox"/>	<input type="checkbox"/>	1661-178	in	
K t/c	0 to 200 °C 24 Hr	34		x	<input type="checkbox"/>	<input checked="" type="checkbox"/>	<input type="checkbox"/>	<input type="checkbox"/>	<input type="checkbox"/>	<input checked="" type="checkbox"/>	<input type="checkbox"/>	<input type="checkbox"/>	<input checked="" type="checkbox"/>	<input type="checkbox"/>	<input type="checkbox"/>	<input checked="" type="checkbox"/>	<input type="checkbox"/>	1660-086	in	
K t/c	0 to 200 Even 24 Hr	130	°F		<input type="checkbox"/>	<input checked="" type="checkbox"/>	<input type="checkbox"/>	<input type="checkbox"/>	<input type="checkbox"/>	<input type="checkbox"/>	<input type="checkbox"/>	<input checked="" type="checkbox"/>	<input type="checkbox"/>	<input checked="" type="checkbox"/>	<input type="checkbox"/>	<input checked="" type="checkbox"/>	<input type="checkbox"/>	1660-010	in	
K t/c	0 to 200 Even 24 Hr	133	°C		<input checked="" type="checkbox"/>	<input type="checkbox"/>	<input checked="" type="checkbox"/>	<input type="checkbox"/>	<input type="checkbox"/>	<input type="checkbox"/>	<input type="checkbox"/>	<input checked="" type="checkbox"/>	<input type="checkbox"/>	<input checked="" type="checkbox"/>	<input type="checkbox"/>	<input checked="" type="checkbox"/>	<input type="checkbox"/>	1660-010	in	
K t/c	0 to 200 Even 7 Day	136	°F		<input type="checkbox"/>	<input type="checkbox"/>	<input type="checkbox"/>	<input checked="" type="checkbox"/>	<input type="checkbox"/>	<input type="checkbox"/>	<input type="checkbox"/>	<input checked="" type="checkbox"/>	<input type="checkbox"/>	<input checked="" type="checkbox"/>	<input type="checkbox"/>	<input checked="" type="checkbox"/>	<input type="checkbox"/>	1661-004	in	
K t/c	0 to 200 Even 7 Day	139	°C		<input checked="" type="checkbox"/>	<input checked="" type="checkbox"/>	<input type="checkbox"/>	<input checked="" type="checkbox"/>	<input type="checkbox"/>	<input type="checkbox"/>	<input type="checkbox"/>	<input checked="" type="checkbox"/>	<input type="checkbox"/>	<input checked="" type="checkbox"/>	<input type="checkbox"/>	<input checked="" type="checkbox"/>	<input type="checkbox"/>	1661-004	in	
K t/c	0 to 400 °F 24 Hr	49		x	<input checked="" type="checkbox"/>	<input type="checkbox"/>	<input type="checkbox"/>	<input type="checkbox"/>	<input checked="" type="checkbox"/>	<input checked="" type="checkbox"/>	<input type="checkbox"/>	<input type="checkbox"/>	<input checked="" type="checkbox"/>	<input type="checkbox"/>	<input type="checkbox"/>	<input checked="" type="checkbox"/>	<input type="checkbox"/>	1660-053	in	
K t/c	0 to 400 °C 24 Hr	51		x	<input checked="" type="checkbox"/>	<input checked="" type="checkbox"/>	<input type="checkbox"/>	<input type="checkbox"/>	<input checked="" type="checkbox"/>	<input checked="" type="checkbox"/>	<input type="checkbox"/>	<input type="checkbox"/>	<input checked="" type="checkbox"/>	<input type="checkbox"/>	<input type="checkbox"/>	<input checked="" type="checkbox"/>	<input type="checkbox"/>	1660-064	in	
K t/c	0 to 400 Even 24 Hr	153	°F		<input checked="" type="checkbox"/>	<input type="checkbox"/>	<input type="checkbox"/>	<input checked="" type="checkbox"/>	<input checked="" type="checkbox"/>	<input type="checkbox"/>	<input type="checkbox"/>	<input checked="" type="checkbox"/>	<input type="checkbox"/>	<input checked="" type="checkbox"/>	<input type="checkbox"/>	<input checked="" type="checkbox"/>	<input type="checkbox"/>	1660-011	in	
K t/c	0 to 400 Even 24 Hr	156	°C		<input type="checkbox"/>	<input type="checkbox"/>	<input checked="" type="checkbox"/>	<input checked="" type="checkbox"/>	<input checked="" type="checkbox"/>	<input type="checkbox"/>	<input type="checkbox"/>	<input checked="" type="checkbox"/>	<input type="checkbox"/>	<input checked="" type="checkbox"/>	<input type="checkbox"/>	<input checked="" type="checkbox"/>	<input type="checkbox"/>	1660-011	in	

Input Type	Chart Type	Con-fig #	EU	Non-Lin	CONFIG SWITCHES (SW1)								INPUT SWITCHES (SW6)						Chart Part Number	R56 ***
					1	2	3	4	5	6	7	8	1	2	3	4	5	6		
K t/c	0 to 400 Even 7 Day	159	°F		■	■	■	■	■	□	□	■	□	☒	□	□	■	□	1661-005	in
K t/c	0 to 400 Even 7 Day	162	°C		□	■	□	□	□	■	□	■	□	☒	□	□	■	□	1661-005	in
K t/c	0 to 500 °F 24 Hr	55		x	■	■	■	□	■	■	□	□	□	☒	□	□	■	□		in
K t/c	0 to 500 °C 24 Hr	98		x	□	■	□	□	□	■	■	□	□	☒	□	□	■	□	1660-205	in
K t/c	0 to 600 °C 24 Hr	58		x	□	■	□	■	■	■	□	□	□	☒	□	□	■	□	1660-059	in
K t/c	0 to 600 Even 24 Hr	168	°C		□	□	□	■	□	■	□	■	□	☒	□	□	■	□	1660-052	in
K t/c	0 to 600 Even 24 Hr	246	°F		□	■	■	□	■	■	■	■	□	☒	□	□	■	□	1660-052	in
K t/c	0 to 600 Even 7 Day	247	°F		■	■	■	□	■	■	■	■	□	☒	□	□	■	□		in
K t/c	0 to 800 °C 24 Hr	61		x	■	□	■	■	■	■	□	□	□	☒	□	□	■	□	1660-060	in
K t/c	0 to 800 Even 24 Hr	171	°F		■	■	□	■	□	■	□	■	□	☒	□	□	■	□	1660-137	in
K t/c	0 to 800 Even 24 Hr	248	°C		□	□	□	■	■	■	■	■	□	☒	□	□	■	□	1660-137	in
K t/c	0 to 1000 °F 24 Hr	62		x	□	■	■	■	■	■	□	□	□	☒	□	□	■	□	1660-007	in
K t/c	0 to 1000 °C 24 Hr	65		x	■	□	□	□	□	□	■	□	□	☒	□	□	■	□	1660-049	in
K t/c	0 to 1000 °C 7 Day	66		x	□	■	□	□	□	□	■	□	□	☒	□	□	■	□	1661-049	in
K t/c	0 to 1000 °F 7 Day	96		x	□	□	□	□	□	■	■	□	□	☒	□	□	■	□	1661-016	in
K t/c	0 to 1000 Even 24 Hr	174	°F		□	■	■	■	□	■	□	■	□	☒	□	□	■	□	1660-173	in
K t/c	0 to 1000 Even 24 Hr	175	°C		■	■	■	■	□	■	□	■	□	☒	□	□	■	□	1660-173	in
K t/c	0 to 1200 °F 24 Hr	68		x	□	□	■	□	□	□	■	□	□	☒	□	□	■	□	1660-006	in
K t/c	0 to 1200 °C 24 Hr	69		x	■	□	■	□	□	□	■	□	□	☒	□	□	■	□	1660-065	in
K t/c	0 to 1200 °F 7 Day	71		x	■	■	■	□	□	□	■	□	□	☒	□	□	■	□	1661-012	in
K t/c	0 to 1200 Even 24 Hr	176	°C		□	□	□	□	■	■	□	■	□	☒	□	□	■	□		in
K t/c	0 to 1200 Even 7 Day	177	°F		■	□	□	□	■	■	□	■	□	☒	□	□	■	□	1661-108	in

Input Type	Chart Type	Con-fig #	EU	Non-Lin	CONFIG SWITCHES (SW1)								INPUT SWITCHES (SW6)						Chart Part Number	R56 ***	
					1	2	3	4	5	6	7	8	1	2	3	4	5	6			
K t/c	0 to 1200 Even 7 Day	235	°C		■	■	□	■	□	■	■	■	□	☒	□	□	■	□	1661-108	in	
K t/c	-18 to 1320 °C 7 Day	105		x	■	□	□	■	□	■	■	□	□	☒	□	□	■	□	1661-031	in	
K t/c	0 to 1600 °F 24 Hr	73		x	■	□	□	■	□	□	■	□	□	☒	□	□	■	□	1660-016	in	
K t/c	0 to 1600 °F 7 Day	74		x	□	■	□	■	□	□	■	□	□	☒	□	□	■	□	1661-013	in	
K t/c	0 to 1600 Even 7 Day	180	°F		□	□	■	□	■	■	□	■	□	☒	□	□	■	□	1661-109	in	
K t/c	1200 to 1600 °F 24 Hr	268		x	□	□	■	■	□	□	□	□	□	☒	□	□	■	□	1660-164	out	
K t/c	0 to 2000 °F 24 Hr	79		x	■	■	■	■	□	□	■	□	□	☒	□	□	■	□	1660-005	in	
K t/c	0 to 2000 °F 7 Day	80		x	□	□	□	□	■	□	■	□	□	☒	□	□	■	□	1661-014	in	
K t/c	0 to 2000 Even 24 Hr	236	°F		□	□	■	■	□	■	■	■	□	☒	□	□	■	□	1660-202	in	
K t/c	0 to 2400 °F 24 Hr	81		x	■	□	□	□	■	□	■	□	□	☒	□	□	■	□	1660-009	in	
K t/c	0 to 2400 °F 7 Day	82		x	□	■	□	□	■	□	■	□	□	☒	□	□	■	□	1661-015	in	
K t/c	0 to 2500 Even 24 Hr	185	°F		■	□	□	■	■	■	□	■	□	☒	□	□	■	□	1660-113	in	
R t/c	0 to 1600 °C 24 Hr	75		x	■	■	□	■	□	□	■	□	□	☒	□	□	■	□	1660-017	in	
R t/c	0 to 1600 Even 7 Day	181	°C		■	□	■	□	■	■	□	■	□	☒	□	□	■	□	1661-109	in	
R t/c	800 to 1600 °C 24 Hr	106		x	□	■	□	■	□	■	■	□	□	☒	□	□	■	□	1660-089	in	
R t/c	0 to 2000 Even 24 Hr	183	°F		■	■	■	□	■	■	□	■	□	☒	□	□	■	□	1660-202	in	
R t/c	0 to 2500 °F 24 Hr	83		x	■	■	□	□	■	□	■	□	□	☒	□	□	■	□	1660-025	in	
R t/c	0 to 2500 °F 7 Day	84		x	□	□	■	□	■	□	■	□	□	☒	□	□	■	□	1661-025	in	
R t/c	30 to 2900 °F 24 Hr	85		x	■	□	■	□	■	□	■	□	□	☒	□	□	■	□	1660-032	in	
R t/c	30 to 2900 °F 7 Day	86		x	□	■	■	□	■	□	■	□	□	☒	□	□	■	□	1661-032	in	
Rem SW1	Digital Pen (off=90%, on=95%)	253			■	□	■	■	■	■	■	■	■	□	☒	□	□	■	□		in
Rem SW2	Digital Pen (off=80%, on=85%)	254			□	■	■	■	■	■	■	■	■	□	☒	□	□	■	□		in

Input Type	Chart Type	Con-fig #	EU	Non-Lin	CONFIG SWITCHES (SW1)								INPUT SWITCHES (SW6)						Chart Part Number	R56 ***
					1	2	3	4	5	6	7	8	1	2	3	4	5	6		
RTD	-80 to 20 Even 7 Day	199	°C		■	■	■	□	□	□	■	■	□	□	■	□	1661-653 (dual range chart)	in		
RTD*	-50 to 25 °C 24 Hr	259		x	■	■	□	□	□	□	□	□	□	□	□	□	1660-048	out		
RTD*	-50 to 25 °C 7 Day	260		x	□	□	■	□	□	□	□	□	□	□	■	□	1661-048	out		
RTD	-25 to 25 Even 7 Day	308	°C		□	□	■	□	■	■	□	□	□	□	■	□		out		
RTD*	-100 to 50 °C 24 Hr	261		x	■	□	■	□	□	□	□	□	□	□	■	□	1660-091	out		
RTD	-50 to 50 °C 24 Hr	19		x	■	■	□	□	■	□	□	□	□	□	■	□		in		
RTD	-50 to 50 Even 24 Hr	212	°C		□	□	■	□	■	□	■	■	□	□	■	□		in		
RTD	-50 to 50 Even 7 Day	213	°C		■	□	■	□	■	□	■	■	□	□	■	□	1661-218	in		
RTD	-5 to 50 Even 24 Hr	112	°C		□	□	□	□	■	■	■	□	□	□	■	□	1660-022	in		
RTD	-5 to 50 Even 7 Day	113	°C		■	□	□	□	■	■	■	□	□	□	■	□	1661-197	in		
RTD	0 to 50 Even 24 Hr	110	°C		□	■	■	■	□	■	■	□	□	□	■	□	1660-104	in		
RTD	0 to 50 Even 7 Day	111	°C		■	■	■	■	□	■	■	□	□	□	■	□	1661-051	in		
RTD	-40 to 60 °C 24 Hr	20		x	□	□	■	□	■	□	□	□	□	□	■	□	1660-067	in		
RTD	-40 to 60 °C 7 Day	91		x	■	■	□	■	■	□	■	□	□	□	■	□	1661-067	in		
RTD	-30 to 70 Even 24 Hr	186	°C		□	■	□	■	■	■	□	■	□	□	■	□	1660-601 (dual range chart)	in		
RTD	-30 to 70 Even 7 Day	187	°C		■	■	□	■	■	■	□	■	□	□	■	□	1661-601 (dual range chart)	in		
RTD	0 to 70 Even 7 Day	196	°C		□	□	■	□	□	□	■	■	□	□	■	□	1661-075	in		
RTD	-35 to 75 Even 24 Hr	192	°C		□	□	□	□	□	□	■	■	□	□	■	□	1660-023	in		
RTD	-35 to 75 Even 7 Day	193	°C		■	□	□	□	□	□	■	■	□	□	■	□	1661-023	in		
RTD	-35 to 75 Even 24 Hr	202	°F		□	■	□	■	□	□	■	■	□	□	■	□	1660-023	in		
RTD	-35 to 75 Even 7 Day	203	°F		■	■	□	■	□	□	■	■	□	□	■	□	1661-023	in		
RTD*	-200 to 100 °F 24 Hr	262		x	□	■	■	□	□	□	□	□	□	□	■	□	1660-044	out		

Input Type	Chart Type	Con-fig #	EU	Non-Lin	CONFIG SWITCHES (SW1)								INPUT SWITCHES (SW6)						Chart Part Number	R56 ***
					1	2	3	4	5	6	7	8	1	2	3	4	5	6		
RTD*	-200 to 100 °F 7 Day	263		x	■	■	■	□	□	□	□	□	□	□	□	□	□	□	1661-044	out
RTD	-100 to 100 °C 7 Day	22		x	□	■	■	□	■	□	□	□	□	□	□	□	□	□	1661-080	in
RTD	-100 to 100 Even 24 Hr	228	°F		□	□	■	□	□	■	■	■	□	□	□	■	□	□	1660-201	in
RTD	-100 to 100 Even 24 Hr	229	°C		■	□	■	□	□	■	■	■	□	□	□	■	□	□	1660-201	in
RTD	-100 to 100 Even 7 Day	279	°F		■	■	■	□	■	□	□	□	□	□	■	□	□		out	
RTD	0 to 100 Even 24 Hr	114	°C		□	■	□	□	■	■	■	□	□	□	■	□	□	1660-001	in	
RTD	0 to 100 Even 24 Hr	115	°F		■	■	□	□	■	■	■	□	□	□	■	□	□	1660-001	in	
RTD	0 to 100 Even 7 Day	116	°C		□	□	■	□	■	■	■	□	□	□	■	□	□	1661-001	in	
RTD	0 to 100 Even 7 Day	117	°F		■	□	■	□	■	■	■	□	□	□	■	□	□	1661-001	in	
RTD	0 to 100 Even 12 Hr	190	°C		□	■	■	■	■	■	□	■	□	□	■	□	□	1903-002	in	
RTD	0 to 150 Even 24 Hr	118	°C		□	■	■	□	■	■	■	□	□	□	■	□	□	1660-180	in	
RTD	0 to 150 Even 7 Day	250	°C		□	■	□	■	■	■	■	■	□	□	■	□	□		in	
RTD*	0 to 150 °C 24 Hr	27		x	■	■	□	■	■	□	□	□	□	□	■	□	□	1660-090	in	
RTD*	50 to 150 °C 24 Hr	28		x	□	□	■	■	■	□	□	□	□	□	■	□	□	1660-116	in	
RTD*	-30 to 170 °F 24 Hr	264		x	□	□	□	■	□	□	□	□	□	□	■	□	□	1660-087	out	
RTD*	-30 to 170 °F 7 Day	265		x	■	□	□	■	□	□	□	□	□	□	■	□	□	1661-087	out	
RTD*	80 to 180 °F 12 Hr	89		x	■	□	□	■	■	□	■	□	□	□	■	□	□	1903-001	in	
RTD	-90 to 190 Even 24 Hr	120	°C		□	□	□	■	■	■	■	□	□	□	■	□	□		in	
RTD	-90 to 190 Even 7 Day	121	°F		■	□	□	■	■	■	■	□	□	□	■	□	□		in	
RTD	-85 to 190 Even 24 Hr	119	°C		■	■	■	□	■	■	■	□	□	□	■	□	□	1660-179	in	
RTD	-100 to 200 °F 24 Hr	29		x	■	□	■	■	■	□	□	□	□	□	■	□	□		in	
RTD	-100 to 200 °F 7 Day	30		x	□	■	■	■	■	□	□	□	□	□	■	□	□		in	

Input Type	Chart Type	Con-fig #	EU	Non-Lin	CONFIG SWITCHES (SW1)								INPUT SWITCHES (SW6)						Chart Part Number	R56 ***	
					1	2	3	4	5	6	7	8	1	2	3	4	5	6			
RTD	-100 to 200 Even 24 Hr	125	°C		■	□	■	■	■	■	■	■	□	□	□	■	□	■	□	1660-232	in
RTD	-100 to 200 Even 24 Hr	127	°F		■	■	■	■	■	■	■	□	□	□	■	□	■	□	1660-232	in	
RTD	-100 to 200 Even 7 Day	128	°C		□	□	□	□	□	□	□	■	□	□	■	□	■	□	1661-178	in	
RTD	-100 to 200 Even 7 Day	245	°F		■	□	■	□	■	■	■	■	□	□	■	□	■	□	1661-178	in	
RTD*	-100 to 200 °C 7 Day	309		x	■	□	■	□	■	■	□	□	□	□	■	□	■	□		out	
RTD	-40 to 200 Even 24 Hr	122	°C		□	■	□	■	■	■	■	□	□	□	■	□	■	□		in	
RTD	-40 to 200 Even 7 Day	123	°C		■	■	□	■	■	■	■	□	□	□	■	□	■	□		in	
RTD	0 to 200 °C 7 Day	33		x	■	□	□	□	□	■	□	□	□	□	■	□	■	□		in	
RTD	0 to 200 Even 24 Hr	131	°F		■	■	□	□	□	□	□	■	□	□	■	□	■	□	1660-010	in	
RTD	0 to 200 Even 24 Hr	134	°C		□	■	■	□	□	□	□	■	□	□	■	□	■	□	1660-010	in	
RTD	0 to 200 Even 7 Day	137	°F		■	□	□	■	□	□	□	■	□	□	■	□	■	□	1661-004	in	
RTD	0 to 200 Even 7 Day	140	°C		□	□	■	■	□	□	□	■	□	□	■	□	■	□	1661-004	in	
RTD	0 to 200 Even 12 Hr	191	°C		■	■	■	■	■	■	□	■	□	□	■	□	■	□	1903-003	in	
RTD	-90 to 210 Even 24 Hr	141	°C		■	□	■	■	□	□	□	■	□	□	■	□	■	□		in	
RTD	-90 to 210 Even 7 Day	142	°F		□	■	■	■	□	□	□	■	□	□	■	□	■	□		in	
RTD	-90 to 210 Even 7 Day	280	°C		□	□	□	■	■	□	□	□	□	□	■	□	■	□		out	
RTD	-90 to 210 Even 24 Hr	281	°F		■	□	□	■	■	□	□	□	□	□	■	□	■	□		Out	
RTD	-50 to 250 Even 24 Hr	194	°C		□	■	□	□	□	□	■	■	□	□	■	□	■	□		In	
RTD	-50 to 250 Even 7 Day	195	°C		■	■	□	□	□	□	■	■	□	□	■	□	■	□		In	
RTD	0 to 250 °F 24 Hr	36		x	□	□	■	□	□	■	□	□	□	□	■	□	■	□	1660-068	In	
RTD	0 to 250 Even 7 Day	251	°F		■	■	□	■	■	■	■	■	□	□	■	□	■	□		in	
RTD	50 to 250 Even 7 Day	208	°F		□	□	□	□	■	□	■	■	□	□	■	□	■	□	1661-003	in	

Input Type	Chart Type	Con-fig #	EU	Non-Lin	CONFIG SWITCHES (SW1)								INPUT SWITCHES (SW6)						Chart Part Number	R56 ***
					1	2	3	4	5	6	7	8	1	2	3	4	5	6		
RTD	50 to 250 Even 24 Hr	209	°F		■	□	□	□	■	□	■	■	□	□	■	□	1660-008	in		
RTD*	-75 to 260°C 24 Hr	266		x	□	■	□	■	□	□	□	□	□	□	■	□		out		
RTD*	-75 to 260°C 7 Day	267		x	■	■	□	■	□	□	□	□	□	□	■	□	1661-055	out		
RTD	0 to 300 Even 24 Hr	144	°C		□	□	□	□	■	□	□	■	□	□	■	□	1660-050	in		
RTD	0 to 300 Even 24 Hr	145	°F		■	□	□	□	■	□	□	■	□	□	■	□	1660-050	in		
RTD	0 to 300 Even 7 Day	146	°C		□	■	□	□	■	□	□	■	□	□	■	□	1661-050	in		
RTD	0 to 300 Even 7 Day	147	°F		■	■	□	□	■	□	□	■	□	□	■	□	1661-050	in		
RTD	0 to 350 Even 24 Hr	218	°F		□	■	□	■	■	□	■	■	□	□	■	□	1660-037	in		
RTD	0 to 350 Even 7 Day	278	°F		□	■	■	□	■	□	□	□	□	□	■	□	1661-037	out		
RTD	-125 to 375 Even 24 Hr	150	°F		□	■	■	□	■	□	□	■	□	□	■	□		in		
RTD	-125 to 375 Even 7 Day	151	°F		■	■	■	□	■	□	□	■	□	□	■	□		in		
RTD*	-125 to 375 °F 24 Hr	42		x	□	■	□	■	□	■	□	□	□	□	■	□	1660-020	in		
RTD*	-125 to 375 °F 7 Day	43		x	■	■	□	■	□	■	□	□	□	□	■	□	1661-020	in		
RTD	0 to 400 Even 24 Hr	154	°F		□	■	□	■	■	□	□	■	□	□	■	□	1660-011	in		
RTD	0 to 400 Even 24 Hr	157	°C		■	□	■	■	■	□	□	■	□	□	■	□	1660-011	in		
RTD	0 to 400 Even 7 Day	160	°F		□	□	□	□	□	■	□	■	□	□	■	□	1661-005	in		
RTD	0 to 400 Even 7 Day	163	°C		■	■	□	□	□	■	□	■	□	□	■	□	1661-005	in		
RTD	-130 to 410 Even 24 Hr	164	°F		□	□	■	□	□	■	□	■	□	□	■	□		in		
RTD	-130 to 410 Even 7 Day	165	°F		■	□	■	□	□	■	□	■	□	□	■	□		in		
RTD	730 to 780 Even 24 Hr (test) <i>(factory configuration)</i>	252	°F		□	□	■	■	■	■	■	■	■	□	■	□		in		
RTD	0 to 800 Even 24 Hr	172	°F		□	□	■	■	□	■	□	■	□	□	■	□	1660-137	in		

Input Type	Chart Type	Con-fig #	EU	Non-Lin	CONFIG SWITCHES (SW1)								INPUT SWITCHES (SW6)						Chart Part Number	R56 ***	
					1	2	3	4	5	6	7	8	1	2	3	4	5	6			
RTD	0 to 800 Even 7 Day	173	°F		■	□	■	■	□	■	□	■	□	□	□	□	□	□	□		in
S t/c	0 to 1600 °C 7 Day	76		x	□	□	■	■	□	□	■	□	□	□	□	□	□	□	□	1660-066	in
S t/c	0 to 1600 Even 7 Day	182	°C		□	■	■	□	■	■	□	■	□	□	□	□	□	□	□	1661-109	in
S t/c	0 to 2000 Even 24 Hr	184	°F		□	□	□	■	■	■	□	■	□	□	□	□	□	□	□	1660-202	in
S t/c	0 to 3000 °F 24 Hr	87		x	■	■	■	□	■	□	■	□	□	□	□	□	□	□	□	1660-147	in
S t/c	0 to 3000 °F 7 Day	88		x	□	□	□	■	■	□	■	□	□	□	□	□	□	□	□	1661-147	in
T t/c	0 to -400 Even 7 Day	284	°F		□	□	■	■	■	□	□	□	□	□	□	□	□	□	□		out
T t/c	0 to -400 Even 24 Hr	285	°F		■	□	■	■	■	□	□	□	□	□	□	□	□	□	□		out
T t/c	0 to -250 Even 7 Day	282	°C		□	■	□	■	■	□	□	□	□	□	□	□	□	□	□		out
T t/c	0 to -250 Even 24 Hr	283	°C		■	■	□	■	■	□	□	□	□	□	□	□	□	□	□		in
T t/c	75 to -200 °C 7 Day	107		x	■	■	□	■	□	■	■	□	□	□	□	□	□	□	□	1661-058	in
T t/c	-80 to 20 Even 7 Day	269	°C		■	□	■	■	□	□	□	□	□	□	□	□	□	□	□	1661-653 (dual range chart)	out
T t/c	-18 to 37 Even 7 Day	271	°C		■	■	■	■	□	□	□	□	□	□	□	□	□	□	□	1661-637 (dual range chart)	out
T t/c	-50 to 50 Even 24 Hr	210	°C		□	■	□	□	■	□	■	■	□	□	□	□	□	□	□		in
T t/c	-50 to 50 Even 7 Day	211	°C		■	■	□	□	■	□	■	■	□	□	□	□	□	□	□	1661-218	in
T t/c	-5 to 50 Even 24 Hr	243	°C		■	■	□	□	■	■	■	■	□	□	□	□	□	□	□	1660-022	in
T t/c	-5 to 50 Even 7 Day	244	°C		□	□	■	□	■	■	■	■	□	□	□	□	□	□	□	1661-197	in
T t/c	-30 to 70 Even 24 Hr	188	°C		□	□	■	■	■	■	□	■	□	□	□	□	□	□	□	1660-601 (dual range chart)	in
T t/c	-30 to 70 Even 7 Day	189	°C		■	□	■	■	■	■	□	■	□	□	□	□	□	□	□	1661-601 (dual range chart)	in
T t/c	-35 to 75 Even 24 Hr	204	°C		□	□	■	■	□	□	■	■	□	□	□	□	□	□	□	1660-023	in
T t/c	-35 to 75 Even 7 Day	205	°C		■	□	■	■	□	□	■	■	□	□	□	□	□	□	□	1661-023	in
T t/c	-35 to 75 Even 24 Hr	206	°F		□	■	■	■	□	□	■	■	□	□	□	□	□	□	□	1660-023	in

Input Type	Chart Type	Con-fig #	EU	Non-Lin	CONFIG SWITCHES (SW1)								INPUT SWITCHES (SW6)						Chart Part Number	R56 ***
					1	2	3	4	5	6	7	8	1	2	3	4	5	6		
T t/c	-35 to 75 Even 7 Day	207	°F		■	■	■	■	□	□	■	■	□	☒	□	□	■	□	1661-023	in
T t/c	-100 to 100 °C 7 Day	21		x	■	□	■	□	■	□	□	□	□	☒	□	□	■	□	1661-069	in
T t/c	-100 to 100 °C 24 Hr	97		x	■	□	□	□	□	■	■	□	□	☒	□	□	■	□	1660-069	in
T t/c	-100 to 100 Even 24 Hr	224	°F		□	□	□	□	□	■	■	■	□	☒	□	□	■	□	1660-201	in
T t/c	-100 to 100 Even 24 Hr	225	°C		■	□	□	□	□	■	■	■	□	☒	□	□	■	□	1660-201	in
T t/c	-100 to 100 Even 7 Day	249	°F		■	□	□	■	■	■	■	■	□	☒	□	□	■	□		in
T t/c	0 to 100 Even 24 Hr	237	°F		■	□	■	■	□	■	■	■	□	☒	□	□	■	□	1660-001	in
T t/c	0 to 100 Even 7 Day	238	°F		□	■	■	■	□	■	■	■	□	☒	□	□	■	□	1661-001	in
T t/c	0 to 100 Even 24 Hr	239	°C		■	■	■	■	□	■	■	■	□	☒	□	□	■	□	1660-001	in
T t/c	0 to 100 Even 7 Day	240	°C		□	□	□	□	■	■	■	■	□	☒	□	□	■	□	1661-001	in
T t/c	-250 to 150 °F 7 Day	93		x	■	□	■	■	■	□	■	□	□	☒	□	□	■	□	1661-042	in
T t/c	-250 to 150 °F 24 Hr	94		x	□	■	■	■	■	□	■	□	□	☒	□	□	■	□	1660-042	in
T t/c	-40 to 150 Even 24 Hr	272	°C		□	□	□	□	■	□	□	□	□	☒	□	□	■	□	1660-660 (dual range chart)	out
T t/c	-40 to 150 Even 7 Day	273	°C		■	□	□	□	■	□	□	□	□	☒	□	□	■	□	1661-660 (dual range chart)	out
T t/c	0 to 150 °C 24 Hr	23		x	■	■	■	□	■	□	□	□	□	☒	□	□	■	□	1660-103	in
T t/c	0 to 150 °C 7 Day	24		x	□	□	□	■	■	□	□	□	□	☒	□	□	■	□		in
T t/c	-90 to 190 Even 24 Hr	270	°C		□	■	■	■	□	□	□	□	□	☒	□	□	■	□		out
T t/c	-100 to 200 °C 24 Hr	31		x	■	■	■	■	■	□	□	□	□	☒	□	□	■	□		in
T t/c	-100 to 200 °C 7 Day	32		x	□	□	□	□	□	■	□	□	□	☒	□	□	■	□		in
T t/c	-100 to 200 Even 24 Hr	124	°F		□	□	■	■	■	■	■	□	□	☒	□	□	■	□	1660-232	in
T t/c	-100 to 200 Even 24 Hr	126	°C		□	■	■	■	■	■	■	□	□	☒	□	□	■	□	1660-232	in
T t/c	-100 to 200 Even 7 Day	241	°F		■	□	□	□	■	■	■	■	□	☒	□	□	■	□	1661-178	in

Input Type	Chart Type	Con-fig #	EU	Non-Lin	CONFIG SWITCHES (SW1)								INPUT SWITCHES (SW6)						Chart Part Number	R56 ***
					1	2	3	4	5	6	7	8	1	2	3	4	5	6		
T t/c	-100 to 200 Even 7 Day	242	°C		<input type="checkbox"/>	<input checked="" type="checkbox"/>	<input type="checkbox"/>	<input type="checkbox"/>	<input checked="" type="checkbox"/>	<input checked="" type="checkbox"/>	<input checked="" type="checkbox"/>	<input checked="" type="checkbox"/>	<input type="checkbox"/>	<input checked="" type="checkbox"/>	<input type="checkbox"/>	<input type="checkbox"/>	<input checked="" type="checkbox"/>	<input type="checkbox"/>	1661-178	in
T t/c	-90 to 210 °C 24 Hr	37		x	<input checked="" type="checkbox"/>	<input type="checkbox"/>	<input checked="" type="checkbox"/>	<input type="checkbox"/>	<input type="checkbox"/>	<input checked="" type="checkbox"/>	<input type="checkbox"/>	<input type="checkbox"/>	<input type="checkbox"/>	<input checked="" type="checkbox"/>	<input type="checkbox"/>	<input type="checkbox"/>	<input checked="" type="checkbox"/>	<input type="checkbox"/>	1660-034	in
T t/c	-90 to 210 °C 7 Day	38		x	<input type="checkbox"/>	<input checked="" type="checkbox"/>	<input checked="" type="checkbox"/>	<input type="checkbox"/>	<input type="checkbox"/>	<input checked="" type="checkbox"/>	<input type="checkbox"/>	<input type="checkbox"/>	<input type="checkbox"/>	<input checked="" type="checkbox"/>	<input type="checkbox"/>	<input type="checkbox"/>	<input checked="" type="checkbox"/>	<input type="checkbox"/>	1661-034	in
T t/c	-40 to 300 Even 24 Hr	274	°F		<input type="checkbox"/>	<input checked="" type="checkbox"/>	<input type="checkbox"/>	<input type="checkbox"/>	<input checked="" type="checkbox"/>	<input type="checkbox"/>	<input type="checkbox"/>	<input type="checkbox"/>	<input type="checkbox"/>	<input checked="" type="checkbox"/>	<input type="checkbox"/>	<input type="checkbox"/>	<input checked="" type="checkbox"/>	<input type="checkbox"/>	1660-661 (dual range chart)	out
T t/c	-40 to 300 Even 7 Day	275	°F		<input checked="" type="checkbox"/>	<input checked="" type="checkbox"/>	<input type="checkbox"/>	<input type="checkbox"/>	<input checked="" type="checkbox"/>	<input type="checkbox"/>	<input type="checkbox"/>	<input type="checkbox"/>	<input type="checkbox"/>	<input checked="" type="checkbox"/>	<input type="checkbox"/>	<input type="checkbox"/>	<input checked="" type="checkbox"/>	<input type="checkbox"/>	1661-661 (dual range chart)	out
T t/c	0 to 300 °C 7 Day	99		x	<input checked="" type="checkbox"/>	<input checked="" type="checkbox"/>	<input type="checkbox"/>	<input type="checkbox"/>	<input type="checkbox"/>	<input checked="" type="checkbox"/>	<input checked="" type="checkbox"/>	<input type="checkbox"/>	<input type="checkbox"/>	<input checked="" type="checkbox"/>	<input type="checkbox"/>	<input type="checkbox"/>	<input checked="" type="checkbox"/>	<input type="checkbox"/>	1661-079	in
T t/c	-125 to 375 Even 24 Hr	276	°F		<input type="checkbox"/>	<input type="checkbox"/>	<input checked="" type="checkbox"/>	<input type="checkbox"/>	<input checked="" type="checkbox"/>	<input type="checkbox"/>	<input type="checkbox"/>	<input type="checkbox"/>	<input type="checkbox"/>	<input checked="" type="checkbox"/>	<input type="checkbox"/>	<input type="checkbox"/>	<input checked="" type="checkbox"/>	<input type="checkbox"/>		out
T t/c	-125 to 375 Even 7 Day	277	°F		<input checked="" type="checkbox"/>	<input type="checkbox"/>	<input checked="" type="checkbox"/>	<input type="checkbox"/>	<input checked="" type="checkbox"/>	<input type="checkbox"/>	<input type="checkbox"/>	<input type="checkbox"/>	<input type="checkbox"/>	<input checked="" type="checkbox"/>	<input type="checkbox"/>	<input type="checkbox"/>	<input checked="" type="checkbox"/>	<input type="checkbox"/>		out
T t/c	-130 to 410 °F 24 Hr	52		x	<input type="checkbox"/>	<input type="checkbox"/>	<input checked="" type="checkbox"/>	<input type="checkbox"/>	<input checked="" type="checkbox"/>	<input checked="" type="checkbox"/>	<input type="checkbox"/>	<input type="checkbox"/>	<input type="checkbox"/>	<input checked="" type="checkbox"/>	<input type="checkbox"/>	<input type="checkbox"/>	<input checked="" type="checkbox"/>	<input type="checkbox"/>	1660-033	in
T t/c	-130 to 410 °F 7 Day	53		x	<input checked="" type="checkbox"/>	<input type="checkbox"/>	<input checked="" type="checkbox"/>	<input type="checkbox"/>	<input checked="" type="checkbox"/>	<input checked="" type="checkbox"/>	<input type="checkbox"/>	<input type="checkbox"/>	<input type="checkbox"/>	<input checked="" type="checkbox"/>	<input type="checkbox"/>	<input type="checkbox"/>	<input checked="" type="checkbox"/>	<input type="checkbox"/>	1661-033	in
W t/c	0 to 1800 °C 24 Hr	77		x	<input checked="" type="checkbox"/>	<input type="checkbox"/>	<input checked="" type="checkbox"/>	<input checked="" type="checkbox"/>	<input type="checkbox"/>	<input type="checkbox"/>	<input checked="" type="checkbox"/>	<input type="checkbox"/>	<input type="checkbox"/>	<input checked="" type="checkbox"/>	<input type="checkbox"/>	<input type="checkbox"/>	<input checked="" type="checkbox"/>	<input type="checkbox"/>	1660-157	in

*IEC Alpha = 0.00391 [all RTDs without an asterisk: IEC Alpha = 0.00385]

**If you set the switches in an ON/OFF combination that does not match any of the given configurations, the recorder will default to configuration #1.

***Refer to Figure 3-1 for location of jumper R56.

3.2.2 Setting SW6 Switch 2

Off for RTD actuation

For thermocouple and mV inputs, the setting of SW6 switch 2 affects the displayed input in case of burnout or other input failure.

Burnout is always upscale on an instrument with no display. When an input fails, the pen is driven upscale. However, if the SW6-2 setting is ON, the pen may be driven downscale momentarily until the input circuit is driven underrange.

It is important, however, to set the switch to OFF in the case of RTD actuation.

ATTENTION

If SW6 switch 2 is ON for an RTD input, the recorder will not be able to process the input accurately, even when the input sensor is providing a valid signal.

3.3 Startup and Operation of Recorder without Display

3.3.1 Overview

Introduction

This subsection provides procedures and reference information for operating the recorder models that do not have a display. It assumes that the recorder has been properly mounted and wired in accordance with the instructions in Section 2, and prepared as described earlier in this section.



WARNING—SHOCK HAZARD



SET THE SWITCHES DESCRIBED IN THIS SECTION WITH THE UNIT POWER DISCONNECTED. DO NOT TOUCH POWER CONNECTIONS AT TB1. FAILURE TO OBSERVE THIS PRECAUTION CAN RESULT IN EXPOSURE TO A POTENTIALLY LETHAL SHOCK HAZARD. MORE THAN ONE SWITCH MAY BE REQUIRED TO DE-ENERGIZE UNIT.

3.3.2 Preparing the Recorder for Operation

Introduction

Before applying power to the recorder, complete these preparation tasks.

ATTENTION

Never move the pen arms when the unit is operating unless adjusting the pen alignment as described in Section 7.

WARNING



SHOCK HAZARD

When the unit is powered a potentially lethal shock hazard exists at the AC line connections at TB1 on each printed circuit assembly (behind the chart plate). Make sure the unit power is disconnected before starting the procedure. More than one switch may be required to de-energize the recorder.

Failure to observe this precaution can result in exposure to a potentially lethal shock hazard.

Procedure

Refer to Figure 3-3 to identify the basic chart plate components and follow the procedure in Table 3-3 to prepare the recorder for operation.

Table 3-3 Preparing the Recorder for Operation

Step	Action
1	Open the door.
2	Pull up on the pen lifter to raise the pen(s) from the chart plate and remove the protective cap from each pen tip. Lift the locking clip on the chart hub.
3	Slip the new chart under the pen lifter, pen and time index, and press it into place over the chart hub.
4	Turn the chart until the desired time line on the chart is aligned with the time index on the chart plate and pen 1 before closing the locking clip on the hub. Push down on the lifter to return the pen(s) to the chart. CAUTION: Do not try to rotate the hub.

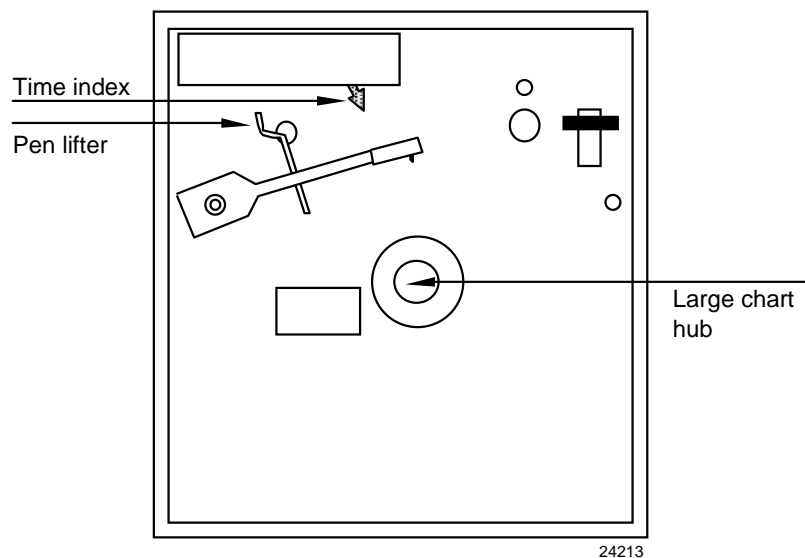

Figure 3-3 Basic Chart Plate Components

3.3.3 Running the Optional Step Test

Introduction

You can test the recorder's mechanical operation by running a "step test". This test is initiated by setting switches as described in Table 3-4.

This test prints a step pattern, which is independent of any chart settings, with horizontal lines drawn by both pens at each 10% increment on the chart (see Figure 3-4).

The test will run for one complete revolution of the chart before it returns to normal operation. The chart revolution for the test takes approximately three minutes, regardless of configured chart speed.

WARNING



SHOCK HAZARD

When the unit is powered a potentially lethal shock hazard exists at the AC line connections at TB1 on each printed circuit assembly (behind the chart plate). Make sure the unit power is disconnected before starting the procedure. More than one switch may be required to de-energize the recorder.

Failure to observe this precaution can result in exposure to a potentially lethal shock hazard.

Procedure

Use the procedure in Table 3-4 to run the step test.

Table 3-4 Procedure for Running the Step Test

Step	Action/Result	Graphic
1	Turn off the power to the recorder.	
2	Make sure the cap is removed from the tip of each pen and the chart is installed.	
3	Loosen captive screw and swing out the chart plate.	
4	Note the position of all eight switches on SW1 on the printed circuit assembly (PCA) for each pen.	See Figure 3-1.
5	Being careful of the shock hazard at TB1 , set switches 1 and 2 in SW1 in the OFF position on each pen's PCA. All other SW1 switches should be ON (toward the edge of the board). This is configuration #252 in Table 3-2.	
6	Being careful of the shock hazard at TB1 , place run switch SW5 to the setup position (toward the top of the board) on each pen's PCA.	
7	Apply power to the recorder.	
8	The recorder will begin the test. The duration of the test is approximately 3 minutes. (When the test has been completed the pens will move away from the test position, but the recorder cannot return to normal operation until the switches are returned to their correct non-test settings.)	

Step	Action/Result	Graphic
9	At the conclusion of the test turn off the power to the recorder.	
10	Being careful of the shock hazard at TB1 , place run switch SW5 to the run position (toward the bottom of the board) on each PCA.	
11	Set configuration switches on the PCA for each pen back to the settings noted in Step 4.	
12	Secure the chart plate in the operational position.	
13	To resume normal operation leave SW5 in the run position and power up the recorder.	

Chart step pattern

Figure 3-4 is a typical chart step pattern generated by the recorder in the step test.

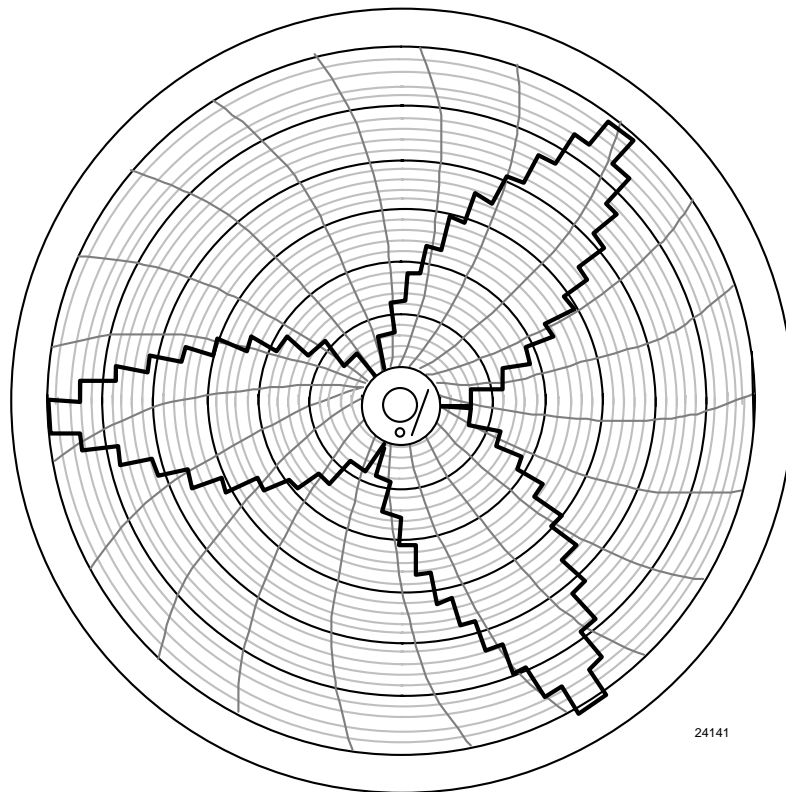

Figure 3-4 Typical Step Test Chart Patterns

3.3.4 Startup

Introduction

The recorder is almost ready for operation when you have:

- mounted and wired the recorder as described in Section 2
- set up the recorder as described in Subsection 3.2
- prepared the recorder as described in Subsection 3.3.2

The only remaining tasks are aligning the chart time and applying power.

Procedure

To set the chart time and apply power, follow the procedure in Table 3-5. (See also Figure 3-5.)

Table 3-5 Startup Procedure

Step	Action
1	Open the door.
2	Pull up the pen lifter to raise the pen(s) from the chart plate. Open the hub locking clip.
3	Turn the chart until the desired time line on the chart is aligned with the time index on the chart plate and pen 1 before closing the locking clip on the hub. Push down on the lifter to return the pen(s) to the chart. CAUTION: Do not try to rotate the hub.
4	Close the door and apply power.
5	The pen(s) will move into position and the recorder will start to track the input value.

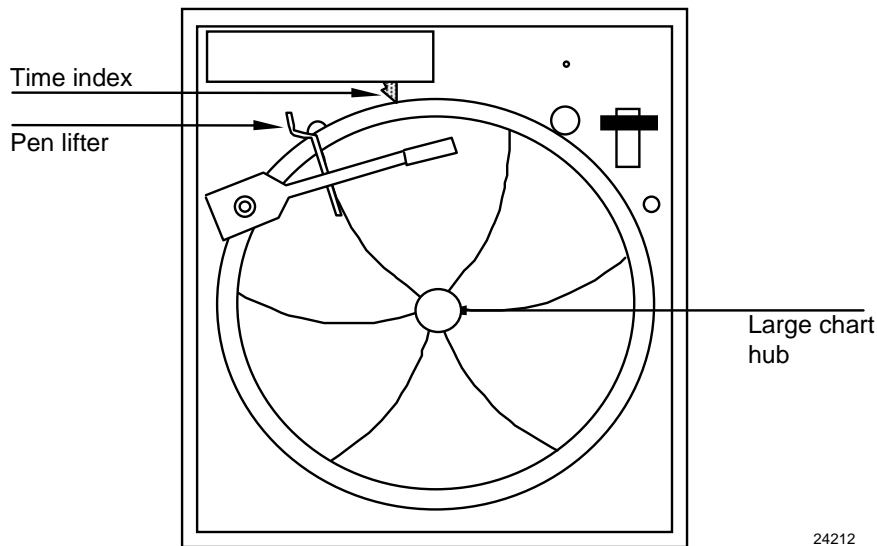

Figure 3-5 Setting Chart Time to Time Index

4. Configuration, Startup and Operation of Recorder with Display

4.1 Overview

Introduction

This section provides instructions for configuring, starting, and operating DR4300 recorder models having a display and keypad.

What's in this section?

The following is a list of topics covered in this section.

Topic	See Page
4.1 Overview	71
4.2 Operator Interface of Recorder with Display and Keypad	72
4.3 Configuration (Recording and Output Set Up)	75
4.4 Startup of Recorder with Display and Keypad	119
4.5 Operation of Recorder with Display and Keypad	128

4.2 Operator Interface on Recorder with Display and Keypad

Introduction

The DR4311, DR4312, DR4331 and DR4332 models include a display and keypad used to view real time values, change setpoints (if the recorder hardware supports outputs), and assign application-specific values to configuration parameters.

This subsection describes the operator interface, using the display and keypad to configure the recorder, and procedures for starting up and operating the recorder.

Displays and indicators

The indicators and text displayed let you see what is happening to your process and how the recorder is responding.

Figure 4-1 is a view of the operator interface. A description of the displays and indicators is included.

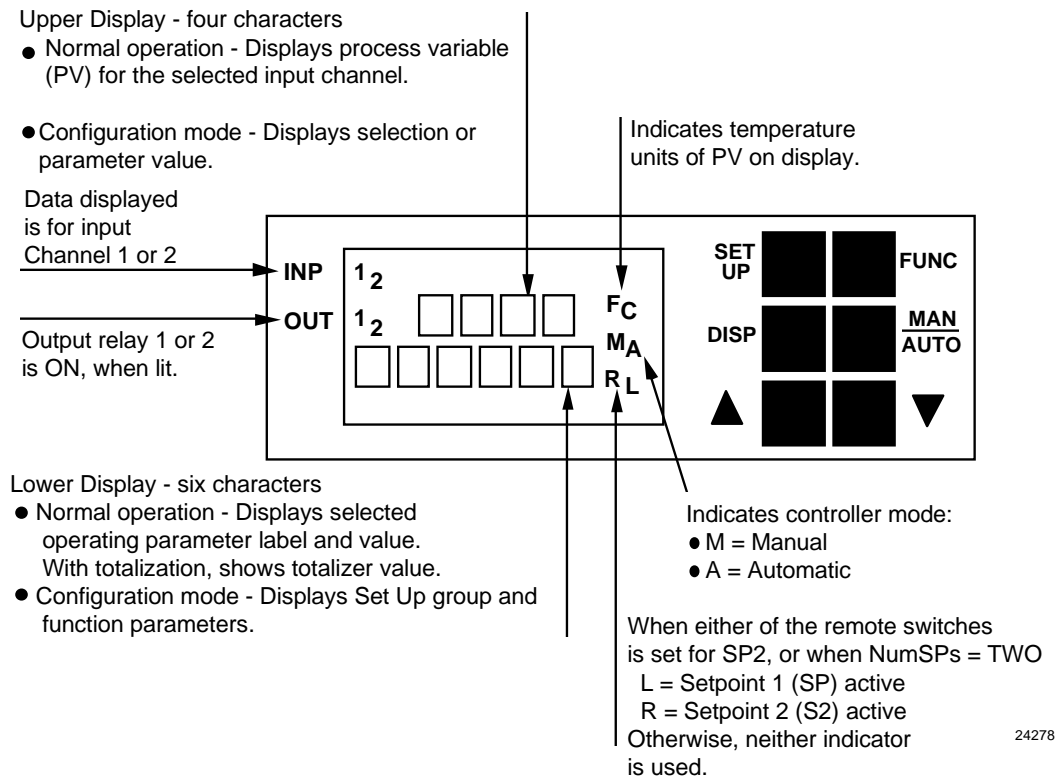





Figure 4-1 Operator Interface

Key functions

Table 4-1 shows each key on the operator interface and defines its function.

Table 4-1 Key Functions

Key	Function
<div style="border: 1px solid black; padding: 5px; text-align: center; width: 40px; margin: auto;">SET UP</div>	<ul style="list-style-type: none"> Places the recorder in the configuration set up group select mode. Sequentially displays set up groups and allows the FUNC key to display function parameters within set up group.
<div style="border: 1px solid black; padding: 5px; text-align: center; width: 40px; margin: auto;">FUNC</div>	<ul style="list-style-type: none"> Used in conjunction with the SET UP key to select the individual functions of a selected configuration set up group. Used to toggle between input channel selection for display (2-pen recorder models only). Used during field calibration procedure.
<div style="border: 1px solid black; padding: 5px; text-align: center; width: 40px; margin: auto;">DISP</div>	<ul style="list-style-type: none"> Pressing this key repeatedly cycles through the operating parameters displayed on the lower display. (Only those parameters required by the supported features will be included in the display cycle.) The input PV for the currently displayed channel is always on the upper display during normal operation. With the exception of "INP", the label shown below will be displayed at the left of the lower display, its value to the right. <ul style="list-style-type: none"> INP = Input; if the recorder does not support any optional features, then this label is always displayed on the lower display. In this case, the other parameters listed below are not applicable. OT = Output SP = Setpoint 1 S2 = Setpoint 2* UseSPn = Setpoint Select (Only appears if Control group NumSPs = TWO) DE = PV Deviation from Setpoint XXXXXX = Totalizer Value  □.□□ = Time Remaining on Optional Timer (Hrs:Min) or  □.□□ = Elapsed Time on Optional Timer (Hrs:Min) (Displayed only if TIMER = ENAB. If "clock hand" is not moving, the timer is not running.) SPRG n = Setpoint Program Select (Displayed only if SPRAMP group SPPROG = ENAB) RUN or HOLD = Status of currently executing setpoint program** N nn.nn = Current Setpoint Program Segment (N) and Time Remaining (nn.nn)** REC nn = Setpoint Program Cycles Remaining** TuneON or TuneOF = Status of Accutune II (Displayed only when Tuning group TUNE = ENAB. See Appendix D for detailed instructions for using Accutune II.)
<div style="border: 1px solid black; padding: 5px; text-align: center; width: 40px; margin: auto;">MAN AUTO RESET</div>	<p>For recorder model with control:</p> <p>MAN/AUTO:</p> <ul style="list-style-type: none"> Alternately selects: <ul style="list-style-type: none"> AUTO Controller is in Automatic mode. MAN Controller is in Manual mode. <p><i>RESET does not apply.</i></p> <p>RESET:</p> <ul style="list-style-type: none"> On Limit Controllers this key functions as RESET, used to take the recorder out of the limit state (once the cause of the limit state has been corrected) and to cause it to resume normal operation, monitoring the value of the input and comparing it to the configured limit value.

Key	Function
	<ul style="list-style-type: none"> Increases the setpoint, output, or configuration values displayed. ***
	<ul style="list-style-type: none"> Decreases the setpoint, output, or configuration values displayed. ***

*The second setpoint is available if one of the digital inputs is configured to use this alternate setpoint in case an external event triggers the “remote switch”, or if Control group parameter NUMSPs = TWO.

**Displayed only when a setpoint program is being executed. REC cycles remaining will be displayed only if the program was set to run more than 1 cycle, and if the program is not executing the last of multiple cycles. See *Appendix C* for detailed instructions for executing a setpoint program.

***If the timer is enabled (TIMER = ENAB) and Timer group parameter START = KEY, then this key can be used to start the timer. To stop the timer before its timeout period has expired, set TIMER = DIS. Once the timer has expired, use the Increment or Decrement key to reset the timer. Relay 2, which was energized when the timer expired, will be de-energized when the timer is reset.

4.3 Configuration (Recording and Output Set Up)

4.3.1 Overview

Introduction

The display and keypad on the DR4311, DR431, DR4331, and DR4332 models are used for setting up recording and output options in Set Up (configuration) mode, as well as for displaying real-time values during normal operation. (Instructions for using the user interface are in Subsection 4.2.)

When the recorder is in configuration mode, setup parameters are displayed, grouped by function. Designate site-specific values by selecting them from a list of choices, or entering them as numeric values.

If your recorder is equipped with two pens, function parameters are configured separately for each pen, and stored on the printed circuit assembly (PCA) associated with that pen. The PCA on the right (when facing recorder) is for pen 1 (purple); the PCA on the left is for pen 2 (red).

If the hardware supports optional relay outputs for each pen, parameters are available for configuring control and/or alarms using these outputs. If an optional relay is used, then it can be wired for Normally Open and Normally Closed action.

Hardware switches must be set to match the input type, and to specify input state in case of input failure.

4.3.2 Configuration Prompts

Diagram: prompt hierarchy

Figure 4-2 is an overview of the hierarchy of set up groups and their associated function prompts. Read the diagram from left to right. (Some prompts may not be displayed, depending on the configuration and lock status of the recorder.)

Figure 4-2 Prompt Hierarchy

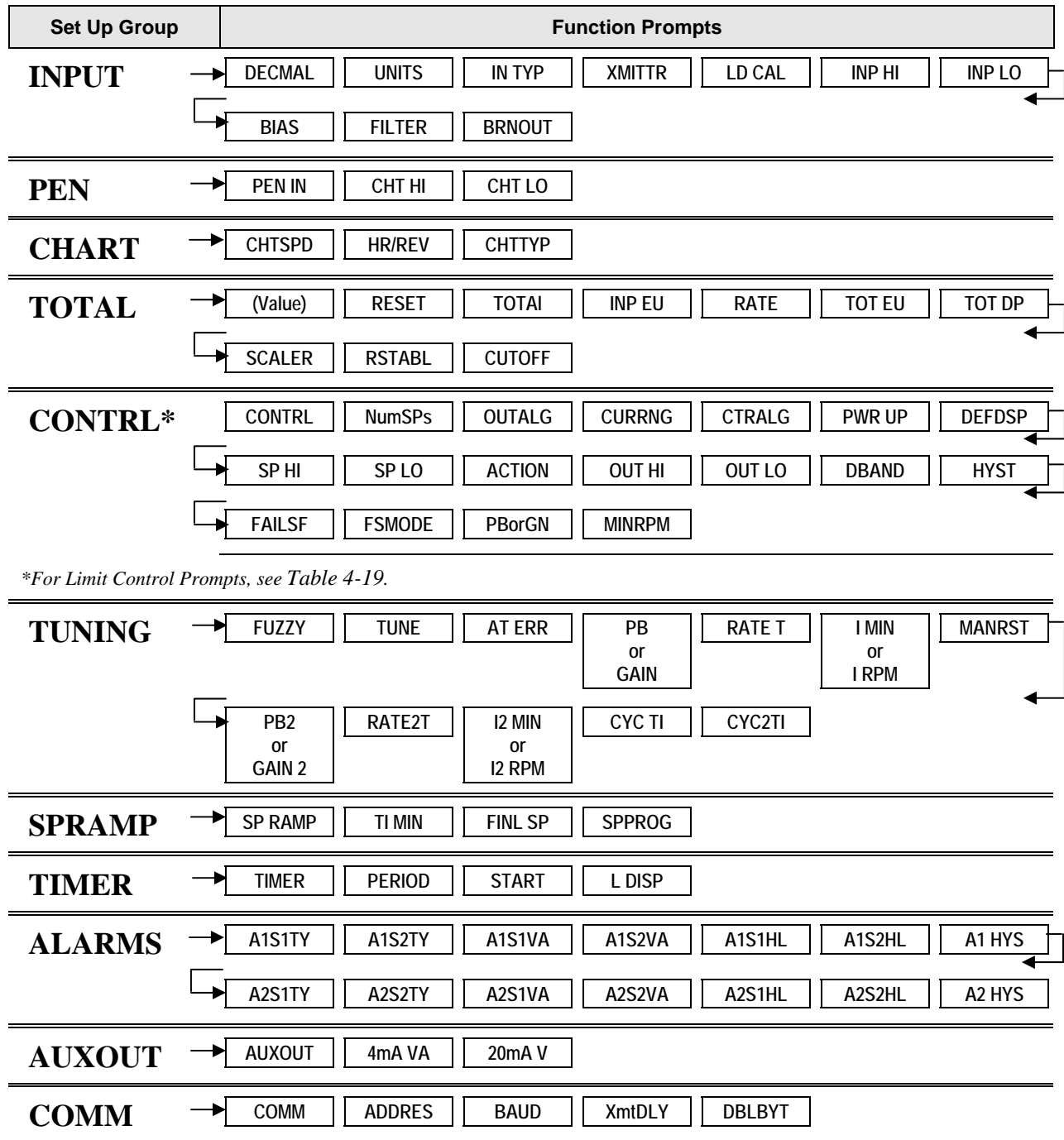

*For Limit Control Prompts, see Table 4-19.

Set Up Group	Function Prompts	
REM SW	→ REMSW1	REMSW2
DSPLAY	→ BLANK	TOGGLE
LOCK	→ LOCK	
ALIN	For pen alignment—see Section 8 of manual	
CAL	For field calibration—see Section 5 of manual	
STATUS	For status displays—see Section 8 of manual	

4.3.3 How to Get Started

Read the configuration tips

Read Subsection 4.3.4 “*Configuration Tips*”. These tips will help you configure your recorder quickly and easily.

Set the hardware switches

Refer to Subsection 4.3.5 “*Switch Settings*” for required hardware switch settings on the printed circuit assembly associated with each pen. The hardware switches should be set before specifying values for function parameters.

Install recorder

Connect the recorder to ac power as described in Section 2 so that you will be able to configure the unit using the display.

Become familiar with the configuration procedure

Read Subsection 4.3.6 “*Configuration Procedure*” to learn how to access the set up groups, and the function parameters within each of these groups (shown in the prompt hierarchy in Figure 4-2).

Assign application-specific values to the set up parameters

The set up groups and function parameters are listed in this section in the order of their appearance on the display. The list includes the name of the prompt, the range of setting or selections available, the definition of each parameter, and the factory setting. It allows you to quickly find a parameter and determine the appropriate value or selection for your application.

Complete configuration record sheet

Subsection 4.3.21 contains a “*Configuration Record Sheet*”. It is good practice to record your instrument’s configuration for future reference.

4.3.4 Configuration Tips

Introduction

Table 4-2 contains tips that will help you enter the configuration data more quickly. If you can not change configuration parameters, check the status of the “LOCK” parameter (see Subsection 4.3.19).

Table 4-2 Configuration Tips

Function	Tip
Displaying Groups	Use the SET UP key to display the set up groups. The group titles are listed in this section in the order that they appear in the recorder.
Displaying Functions	Use the FUNC key to display the individual function parameters under each group. The prompts are listed in the order of their appearance in each group.
Scrolling	Holding the SET UP key in will scroll through the set up groups. However, when any set up group is displayed, you can scroll through the set up groups twice as fast using the σ or τ key. When in any set up group, hold the FUNC key in to scroll through the prompts within that group.
Changing values quickly	When changing the value of a parameter, you can adjust a more significant digit in the upper display by holding in one key [σ] or [τ], and pressing the other [σ] or [τ] at the same time. <ul style="list-style-type: none"> • The adjustment will move one digit to the left. • Press the key again and you will move one more digit to the left.
Exiting Set Up mode	To exit Set Up mode, press the DISP key. This returns the display to the same state it was in immediately preceding entry into the Set Up mode.
Timing out from Set Up mode	If you are in Set Up (configuration) mode and do not press any keys for one minute, the recorder will time out and revert to the mode and display that was being used prior to entry into Set Up mode.

4.3.5 Switch Settings

4.3.5.1 Introduction

Significance of hardware switches in models with display

SW6 input switches: The display and keypad are used to configure the software on each pen channel's printed circuit assembly (PCA). In addition, the input hardware switches 1, 3, 4, 5 and 6 in SW6 must be set to match the input type as described in Subsection 4.3.5.2. This is required so that the recorder hardware will provide an appropriate value to the recorder software.

SW6 burnout switch 2: This burnout switch should be set to specify whether the input used by the recorder for the channel should be sent over range or under range if the input to the recorder fails while the "BRNOUT" parameter value is "NONE". Alternatively, if the "BRNOUT" parameter has a value of "UP" or "DOWN" switch 2 should be set to match. Details are provided in Subsection 4.3.5.3.

SW1 configuration switches: In a recorder model having a display and keypad all switches in SW1 will be ignored if the cable from the display and keypad assembly is plugged into J4 on the PCA associated with the pen channel. (SW1 switches are used to configure recorder models that do not have a display and keypad as described in Section 3.)

ATTENTION

If the display cable is disconnected after the software has been configured using the display and keypad, the recorder's behavior will depend on the settings of the SW1 switches. If all SW1 switches are in the OFF position when the cable is disconnected, the recorder will continue to use the software configuration entered with the display and keypad. However, if all SW1 switches are not OFF when the cable is disconnected, the recorder will use the configuration in Table 3-2 that matches the SW1 switch settings. (If the switch setting combination does not match any configuration in Table 3-2, the recorder will use configuration #1.)

Safety precautions

Exercise appropriate safety precautions when setting switches.



WARNING—SHOCK HAZARD



SET THE SWITCHES DESCRIBED IN THIS SECTION WITH THE UNIT POWER DISCONNECTED. DO NOT TOUCH POWER CONNECTIONS AT TB1. FAILURE TO OBSERVE THIS PRECAUTION CAN RESULT IN EXPOSURE TO A POTENTIALLY LETHAL SHOCK HAZARD. MORE THAN ONE SWITCH MAY BE REQUIRED TO DE-ENERGIZE UNIT.

4.3.5.2 Setting SW6 Input Switches

SW6 switches 1, 3, 4, 5, 6 define input type

In a recorder model having a display and keypad the input switches at SW6 must be set to match the type of input to be used. The location of SW6 is shown in Figure 4-3. The appropriate switch settings for the various input types are shown in Table 4-3.

Note that the setting of switch 2 in SW6 is not related to input type. It is used, along with the “BRNOUT” parameter in the input group, to specify the effects of an input failure as described in Subsection 4.3.5.3.

ATTENTION

The ON position for SW6 switches is toward the left side of the printed circuit assembly (when facing recorder.)

Table 4-3 SW6 Input Switch Settings for Models Having Display and Keypad

Input Type	SW6 Input Switch Settings					
	1	2	3	4	5	6
0 V to 1 V	off	★	off	ON	off	off
0 V to 2 V	off	★	off	ON	off	off
0 V to 5 V	off	★	off	ON	off	off
0 V to 10 V	off	★	off	ON	off	off
2 V to 10 V	off	★	off	ON	off	off
1 V to 5 V	off	★	off	ON	off	off
0 mV to 10 mV	off	★	off	off	ON	off
0 mV to 100 mV	off	★	off	off	ON	off
0 to 200 mV	ON	★	off	off	off	off
0 mA to 20 mA	off	★	off	ON	off	ON
4 mA to 20 mA	off	★	off	ON	off	ON
all thermocouples	off	★	off	off	ON	off
all RTDs	off	off	ON	off	ON	off

★ This switch is used to select whether the input value used by the recorder should be driven over range or under range in case of input failure. See Subsection 4.3.5.3.

SW6 Input Switch

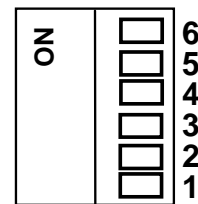

4.3.5.3 Setting SW6 Burnout Switch

Overview

What happens to the displayed input value when the input signal to the recorder fails depends on several factors: the input type, the setting of SW6 switch 2, and the value of the “BRNOUT” parameter in the input set up group.

SW6 switch 2 OFF for RTD

If the input to the pen channel is from an RTD, SW6 switch 2 must always be set to OFF.

CAUTION

If SW6 switch 2 is ON for an RTD input, the recorder will not be able to process the input correctly, even when the input sensor is providing a valid input signal.

SW6 switch 2 setting unimportant for Volt, mV, and mA inputs

It does not matter whether SW6 switch 2 is ON or OFF if the pen channel uses a Volt, mV, or mA input signal. In case of input failure, the displayed input value will show little change, regardless of the setting of SW6 switch 2 or the value assigned to the “BRNOUT” parameter. (However, the value of “BRNOUT” is still important to implementing your control strategy because the value of “BRNOUT” affects the **output** used in case of input failure. See Subsection 4.3.11 for details.)

SW6 switch 2 setting determines displayed thermocouple input if BRNOUT = NONE

If the value of “BRNOUT” is “NONE” when a thermocouple input fails, then the setting of SW6 switch 2 determines whether the displayed input value will be under range or over range. The recorder can display 1 % over or under range for thermocouples.

- If SW6 switch 2 is ON, the displayed value will be under range.
- If SW6 switch 2 is OFF, the displayed value will be over range.

If the pen is configured to trace the input value (“PENIN” pen set up parameter value is “INP”), then the pen will also be driven over or under range.

Note that the over range or under range input will have no effect on **output**. When “BRNOUT” = “NONE”, the recorder uses the configured failsafe value as the output in case of input failure, rather than a calculated value based on input.

SW6 switch 2 setting for thermocouple inputs should match BRNOUT if BRNOUT = UP OR DOWN

We recommend that, in the case of thermocouple inputs, SW6 switch 2 be set to OFF if “BRNOUT” = “UP” and ON if “BRNOUT” = “DOWN”.

When the input failure first occurs, the displayed input for a thermocouple input will briefly be driven according to the hardware switch setting. However, as soon as the software recognizes that it has received an out-of-range input signal, the displayed input will be driven according to the value, “UP” or “DOWN”, configured for “BRNOUT”. The displayed value (over range or under range) as configured in “BRNOUT”, will remain on the display until a valid input is restored.

If the switch and the set up parameter do not match, operator confusion may result. For example, in case of mismatch the displayed value could first go under range, then quickly go over range. However, except for the brief period before the software reacts to the out-of-range value, the effect of the mismatch is insignificant.

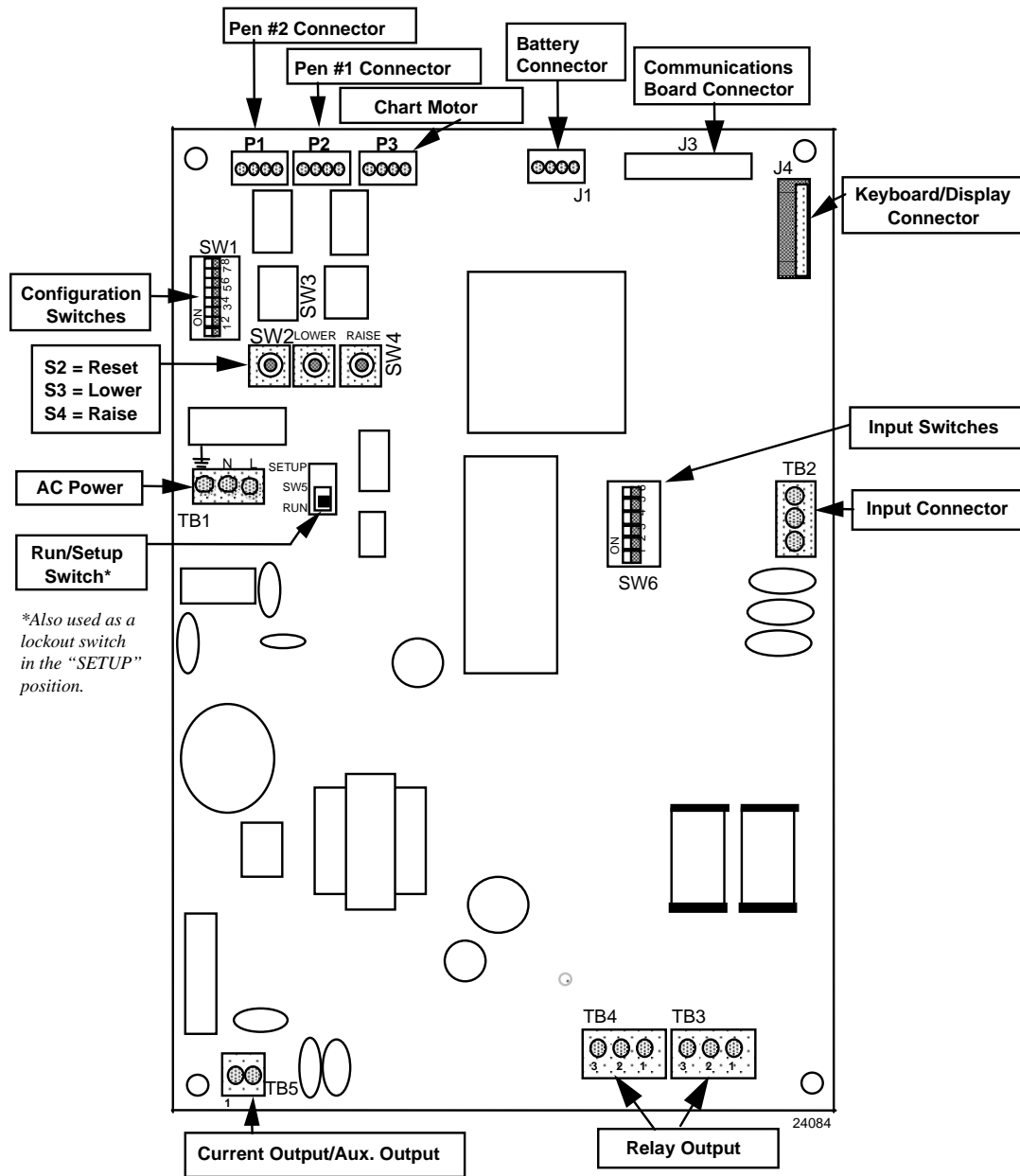

Figure 4-3 Location of Switches and Relays

4.3.6 Configuration Procedure

Introduction

The configuration prompts are sequenced in a group/function hierarchy as shown in Figure 4-2. Once you have set the input switches in SW6 as described in Subsection 4.3.5, configure all the function parameters that are applicable for your recorder model and application. During configuration some function parameters will not be displayed if they do not apply to your application. For example, if you set the control group function “CONTRL” to “DIS”, disabling control, then no other control group prompts will be displayed.

To enter your selections or values, follow the procedure in Table 4-4 and fill in the values or selections on the worksheet in Subsection 4.3.21. Keep this worksheet as a record of how your recorder was configured.

This procedure tells you the keys to press to get to any set up group (and any associated function parameters prompt).







Procedure

Follow the procedure listed in Table 4-4 to access the set up groups and function prompts. If you have a 2-pen recorder, be sure to identify individual parameters for each pen and control loop as applicable.

Make sure lock set up group “LOCK” function is set to “NONE” or “CAL.” See Subsection 4.3.19.

Table 4-4 Configuration Procedure

Step	Operation	Press	Result
1	Select Set Up mode	SET UP	<p>Upper Display <input type="text" value="SET"/></p> <p>Lets you know you are in the configuration mode and a set up group title is being displayed in the lower display.</p> <p>Lower Display <input type="text" value="INPUT"/></p> <p>This is the first set up group title.</p>
2	Select any set up group	SET UP	<ul style="list-style-type: none"> • Successive presses of the <input type="text" value="SET UP"/> key will display the other set up group titles shown in the prompt hierarchy in Figure 4-2. • You can also use the [σ] [τ] keys to scan the set up groups in both directions. • Stop at the set up group title which describes the group of parameters you want to configure. Then proceed to the next step.
3	Select a function parameter	FUNC	<p>Upper Display <input type="text" value="XXXX"/></p> <p>Shows the current value or selection for the first function prompt of the set up group that you have selected.</p> <p>Lower Display <input type="text" value="DECMAL"/></p> <p>Shows the first function prompt within the selected set up group.</p> <p>Example displays show Input group function prompt “DECMAL” and the value selected.</p>

Step	Operation	Press	Result
4	Select other function parameters		<ul style="list-style-type: none"> • Successive presses of the FUNC key will sequentially display the other function prompts of the set up group you have selected. • Stop at the function prompt that you want to change, then proceed to the next step.
5	Change the value or selection	 or 	<ul style="list-style-type: none"> • These keys increment or decrement the value or selection that appears for the function prompt you have selected. • See Subsection 4.3.4 <i>Configuration Tips</i> for instructions to increase or decrease value quickly. • Change the value or selection to meet your needs. • If the display flashes, you are trying to make an unacceptable entry.
6	Enter the value or selection	 or 	<ul style="list-style-type: none"> • This key selects another function prompt. • This key selects another set up group. <p>The value or selection you have made will be entered into memory after another key is pressed.</p>
7	Exit Configuration		This exits configuration mode and returns the recorder to the same state it was in immediately before you entered configuration mode. Any changes made during the configuration session are stored when configuration mode is exited.
8	2-Pen Recorders		For 2-pen recorders, press FUNC key to select INP 2 for display and return to step 1 to configure the parameters for pen 2.

4.3.7 Input Parameters Set Up Group

Introduction

These are the parameters required to configure the temperature units, decimal location, actuation, high and low range values in engineering units, bias, filter, and burnout. For a 2-pen recorder, the desired input channel is displayed on the left side of the operator interface.

Press **FUNC** key to select channel.

Input group prompts

Table 4-5 lists all the function prompts in the input set up group.

Press **SETUP** key until “INPUT” appears in the lower display.

Press **FUNC** key to display the parameters.

Table 4-5 Input Parameter Definitions

Lower Display Prompt	Upper Display Range of Setting or Selection	Parameter Definition
DECMAL	XXXX <i>[factory setting]</i> XXX.X XX.XX	DECIMAL POINT LOCATION —This selection determines where the decimal point appears in the display. None One Place Two Places NOTE: Be sure the selection agrees with the value to be displayed. If PV requires 4 whole digits, the decimal will not show. Value of “IN TYP” parameter must be for a linear input type for two decimal places to be displayed.
UNITS	NONE F <i>[factory setting]</i> C	TEMPERATURE UNITS —This selection will be indicated on the PV display. No units Degrees Fahrenheit Degrees Celsius

Lower Display Prompt	Upper Display Range of Setting or Selection	Parameter Definition																																																																																				
<p>IN TYP</p> <p>B EH EL JH JL KH KL NNM NIC</p> <p>R S TH TL W</p> <p>100 H*<i>[factory setting]</i> 100 L* 100 T** 4-20*** 0-20*** 10m*** 100m*** 200m*** 0-1*** 0-2*** 1-5*** 0-5*** 0-10*** 2-10***</p> <p>* IEC Alpha = 0.00385 **IEC Alpha = 0.00391 ***These input selections are not available on Limit Control units.</p>		<p>INPUT ACTUATION TYPE—This selection specifies what actuation you are going to use for the input. Be sure that the values configured for the high and low chart range, alarm setpoint, etc. are within the measuring range for the selected actuation type.</p> <table border="0"> <tr> <td>B thermocouple</td> <td>105 to 3300°F</td> <td>41 to 1815°C</td> </tr> <tr> <td>E thermocouple high</td> <td>-454 to 1832°F</td> <td>-270 to 1000°C</td> </tr> <tr> <td>E thermocouple low</td> <td>-200 to 1100°F</td> <td>-129 to 593°C</td> </tr> <tr> <td>J thermocouple high</td> <td>0 to 1600°F</td> <td>-18 to 871°C</td> </tr> <tr> <td>J thermocouple low</td> <td>20 to 770°F</td> <td>-7 to 410°C</td> </tr> <tr> <td>K thermocouple high</td> <td>-320 to 2500°F</td> <td>-196 to 1371°C</td> </tr> <tr> <td>K thermocouple low</td> <td>-20 to 1000°F</td> <td>-29 to 538°C</td> </tr> <tr> <td>NiNiMo thermocouple</td> <td>32 to 2500°F</td> <td>0 to 1371°C</td> </tr> <tr> <td>Nicrosil-Nisil thermocouple</td> <td>0 to 2372°F</td> <td>-18.8 to 1300°C</td> </tr> <tr> <td>R thermocouple</td> <td>0 to 3100°F</td> <td>-18 to 1704°C</td> </tr> <tr> <td>S thermocouple</td> <td>0 to 3100°F</td> <td>-18 to 1704°C</td> </tr> <tr> <td>T thermocouple high</td> <td>-420 to 700°F</td> <td>-251 to 371°C</td> </tr> <tr> <td>T thermocouple low</td> <td>-200 to 600°F</td> <td>-129 to 316°C</td> </tr> <tr> <td>W thermocouple</td> <td>0 to 4200°F</td> <td>-18 to 2316°C</td> </tr> <tr> <td>100 Ohm-RTD (high)</td> <td>-300 to 900°F</td> <td>-184 to 482°C</td> </tr> <tr> <td>100 Ohm-RTD (low)</td> <td>-130 to 392°F</td> <td>-90 to 200°C</td> </tr> <tr> <td>100 Ohm-RTD (special)</td> <td>-238 to 482°F</td> <td>-150 to 250°C</td> </tr> <tr> <td>4 to 20 Milliamps</td> <td></td> <td></td> </tr> <tr> <td>0 to 20 Milliamps</td> <td></td> <td></td> </tr> <tr> <td>0 to 10 Millivolts</td> <td></td> <td></td> </tr> <tr> <td>0 to 100 Millivolts</td> <td></td> <td></td> </tr> <tr> <td>0 to 200 Millivolts</td> <td></td> <td></td> </tr> <tr> <td>0 to 1 Volt</td> <td></td> <td></td> </tr> <tr> <td>0 to 2 Volts</td> <td></td> <td></td> </tr> <tr> <td>1 to 5 Volts</td> <td></td> <td></td> </tr> <tr> <td>0 to 5 Volts</td> <td></td> <td></td> </tr> <tr> <td>0 to 10 Volts</td> <td></td> <td></td> </tr> <tr> <td>2 to 10 Volts</td> <td></td> <td></td> </tr> </table>	B thermocouple	105 to 3300°F	41 to 1815°C	E thermocouple high	-454 to 1832°F	-270 to 1000°C	E thermocouple low	-200 to 1100°F	-129 to 593°C	J thermocouple high	0 to 1600°F	-18 to 871°C	J thermocouple low	20 to 770°F	-7 to 410°C	K thermocouple high	-320 to 2500°F	-196 to 1371°C	K thermocouple low	-20 to 1000°F	-29 to 538°C	NiNiMo thermocouple	32 to 2500°F	0 to 1371°C	Nicrosil-Nisil thermocouple	0 to 2372°F	-18.8 to 1300°C	R thermocouple	0 to 3100°F	-18 to 1704°C	S thermocouple	0 to 3100°F	-18 to 1704°C	T thermocouple high	-420 to 700°F	-251 to 371°C	T thermocouple low	-200 to 600°F	-129 to 316°C	W thermocouple	0 to 4200°F	-18 to 2316°C	100 Ohm-RTD (high)	-300 to 900°F	-184 to 482°C	100 Ohm-RTD (low)	-130 to 392°F	-90 to 200°C	100 Ohm-RTD (special)	-238 to 482°F	-150 to 250°C	4 to 20 Milliamps			0 to 20 Milliamps			0 to 10 Millivolts			0 to 100 Millivolts			0 to 200 Millivolts			0 to 1 Volt			0 to 2 Volts			1 to 5 Volts			0 to 5 Volts			0 to 10 Volts			2 to 10 Volts		
B thermocouple	105 to 3300°F	41 to 1815°C																																																																																				
E thermocouple high	-454 to 1832°F	-270 to 1000°C																																																																																				
E thermocouple low	-200 to 1100°F	-129 to 593°C																																																																																				
J thermocouple high	0 to 1600°F	-18 to 871°C																																																																																				
J thermocouple low	20 to 770°F	-7 to 410°C																																																																																				
K thermocouple high	-320 to 2500°F	-196 to 1371°C																																																																																				
K thermocouple low	-20 to 1000°F	-29 to 538°C																																																																																				
NiNiMo thermocouple	32 to 2500°F	0 to 1371°C																																																																																				
Nicrosil-Nisil thermocouple	0 to 2372°F	-18.8 to 1300°C																																																																																				
R thermocouple	0 to 3100°F	-18 to 1704°C																																																																																				
S thermocouple	0 to 3100°F	-18 to 1704°C																																																																																				
T thermocouple high	-420 to 700°F	-251 to 371°C																																																																																				
T thermocouple low	-200 to 600°F	-129 to 316°C																																																																																				
W thermocouple	0 to 4200°F	-18 to 2316°C																																																																																				
100 Ohm-RTD (high)	-300 to 900°F	-184 to 482°C																																																																																				
100 Ohm-RTD (low)	-130 to 392°F	-90 to 200°C																																																																																				
100 Ohm-RTD (special)	-238 to 482°F	-150 to 250°C																																																																																				
4 to 20 Milliamps																																																																																						
0 to 20 Milliamps																																																																																						
0 to 10 Millivolts																																																																																						
0 to 100 Millivolts																																																																																						
0 to 200 Millivolts																																																																																						
0 to 1 Volt																																																																																						
0 to 2 Volts																																																																																						
1 to 5 Volts																																																																																						
0 to 5 Volts																																																																																						
0 to 10 Volts																																																																																						
2 to 10 Volts																																																																																						
<p>XMITTR</p> <p>Lin <i>[factory setting]</i> Srt</p>		<p>Transmitter Input Type—Use this parameter to specify whether the input should be used as the PV without characterization (linear) or the square root of the input should be used as the PV.</p> <p>Linear—No characterization applied to input.</p> <p>Square Root—PV is the square root of input. For example: suppose the linear input range is 0 to 5000 and the input type is 0 to 5 volts. Then if input = 2.5 V = 50 %,</p> $\sqrt{.50} = .7071 = 70.71\%$ $.7071 \times 5000 = 3535 = PV$																																																																																				

Lower Display Prompt	Upper Display Range of Setting or Selection	Parameter Definition
LD CAL	FAC [<i>factory setting</i>] FLD	<p>LOAD CALIBRATION VALUES—This parameter is used to specify which set of calibration values you want to use.</p> <p>Factory—Uses built-in calibration values (stored in read-only memory).</p> <p>Field—Uses calibration values stored as a result of the field calibration procedure described in Section 5.</p> <p>ATTENTION Until field calibration has been done, FLD uses the same calibration values as FAC. When field calibration is performed, the value of LD CAL is automatically set to FLD at the completion of the field calibration operation.</p>
INP HI	–999 to 9999 <i>[factory setting = 900]</i>	<p>INPUT HIGH RANGE VALUE in engineering units is displayed but can only be configured for linear input type.</p> <p>Otherwise, this is a read-only display of the higher range value for the selected T/C or RTD input type.</p> <ul style="list-style-type: none"> Scale the input signal to the display value you want for 100 %. EXAMPLE: Actuation (Input) = 4 to 20 mA Process Variable = Flow Range of Flow = 0 to 250 Gal/Min High Range display value = 250 Then 20 mA = 250 Gal/Min
INP LO	–999 to 9999 in Engineering Units <i>[factory setting = –300]</i>	<p>INPUT LOW RANGE VALUE in engineering units is displayed but can only be configured for linear input type.</p> <ul style="list-style-type: none"> Otherwise, this is a read-only display of the low range value for the selected T/C or RTD input type. Scale the input signal to the display value you want for 0 %. See example in “INPHI”.
BIAS	–99.9 to 999.9 <i>[factory setting = 0]</i>	<p>INPUT BIAS—Used to compensate the input for drift of an input value due to deterioration of a sensor, or some other cause; select the value you want on the input.</p>
FILTER	0 to 120 seconds No filter = 0 <i>[factory setting = 0]</i>	<p>FILTER FOR INPUT—A software digital filter is provided for the input to smooth the input signal. You can configure the first order lag time constant from 1 to 120 seconds. If you do not want filtering, enter 0.</p>

Lower Display Prompt	Upper Display Range of Setting or Selection	Parameter Definition
<p>BRNOUT</p>	<p>NONE <i>[factory setting]</i></p> <p>UP</p> <p>DOWN</p>	<p>BURNOUT PROTECTION (INPUT FAILURE) provides most input types with upscale or downscale protection if the input fails. Note that if the input fails, error message “INP FL” will be on the lower display.</p> <p>ATTENTION Refer to Subsection 4.5 for information about the interaction of the value of this parameter and the setting of switch 2 on SW6.</p> <p>NO BURNOUT—Failsafe output applied for failed input.</p> <p>UPSCALE BURNOUT will make the indicated PV signal go to overrange value when input fails. Control algorithm will use overrange value when calculating output.</p> <p>DOWNSCALE BURNOUT will make the indicated PV signal go to underrange value when input fails. Control algorithm will use underrange value when calculating output.</p>

NOTE: For recorders with the FM Limit Approved Option the INPUT configuration does not provide a burnout selection. However, if a HI limit is configured and the input opens, the input reading will go Upscale and the lower display will alternate between: INP#, Limit, and INP FL.

If a LO limit is configured and the input opens, the input reading will go down scale and the lower display will alternate between: INP#, Limit, and INP FL.

4.3.8 Pen Parameters Set Up Group

Introduction

The functions in this group are used to configure the pen(s). The procedure for configuring each pen is the same. For a 2-pen recorder, the desired input channel is displayed on the left side of the operator interface.

Press **FUNC** key to select channel.

Pen group prompts

Table 4-6 lists all the function prompts in the pen set up group.

Press the **SET UP** key until “PEN” appears in the lower display.

Press **FUNC** key to display parameters.

Table 4-6 Pen Parameter Definitions

Lower Display Prompt	Upper Display Range of Setting or Selection	Parameter Definition
PEN IN	INP [factory setting] REM1 REM2 OUT* SP*	PEN INPUT —What do you want the pen to record? INPUT —Records the input for given channel. REMOTE SWITCH 1 EVENT —Records the digital input event for given channel. (Event toggles pen between 90 % and 95 % on chart.) REMOTE SWITCH 2 EVENT —Records the digital input event for given channel. (Event toggles pen between 80 % and 85 % on chart.) OUTPUT —Records the output for the channel. SETPOINT —Records setpoint for given channel. <i>*Only selectable if hardware supports outputs and function prompt “CONTRL” in Control group is set to “ENAB” (enabled).</i>
CHT HI	–999 to 9999 <i>[factory setting = 780]</i>	CHART HIGH RANGE VALUE —Enter a value that corresponds with the chart high range value for the pen. (This is the value that prints at the outer edge of the chart. If you had a range of 0 °C to –400 °C, –400 would be the chart high range value.)
CHT LO	–999 to 9999 <i>[factory setting = 730]</i>	CHART RANGE LOW VALUE —Enter a value that corresponds with the chart low range value for the pen.

4.3.9 Chart Parameters Set Up Group

Introduction

The functions in this group are used to specify proper chart function. For a 2-pen recorder the desired input channel is displayed on the left side of the operator interface.

Press **FUNC** key to select channel.

Chart group prompts

Table 4-7 lists all the function prompts in the chart parameters set up group.

Press **SET UP** key until “CHART” appears in the lower display.

Press **FUNC** key to display parameters.

Table 4-7 Chart Parameter Definitions

Lower Display Prompt	Upper Display Range of Setting or Selection	Parameter Definition
CHTSPD	8HR 12HR 24HR <i>[factory setting]</i> 7DAYS – HR	CHART SPEED —This is the time it will take to drive the chart one complete revolution. ATTENTION This prompt only appears for pen 1 configuration of a two-pen recorder. 8 hour revolution 12 hour revolution 24 hour revolution 7 day revolution – hour revolution—specify Hours per Revolution selection at prompt “HR/REV”.
HR/REV	1 to 744 Hours	HOURS PER REVOLUTION —Set the desired chart speed. Appears only if – HR was selected at prompt “CHTSPD”.
CHTTYP	LIN <i>[factory setting]</i> NLIN	CHART TYPE —Selection is based on the type of chart. Linear (even) or Non-Linear (i.e., J T/C or RTD) ATTENTION LIN chart type is automatically selected when input type is linear (as defined by value of input set up parameter “INTYP”).

4.3.10 Totalizer Parameters Set Up Group

Introduction

If the recorder hardware supports totalizer functions, the functions in this group are used to calculate and display the total flow volume as measured by the input. The displayed value is six digits with a configurable scale factor.

The totalized value can be in engineering units different from the input, by setting INP EU (engineering units of input) and TOT EU (engineering units of totalized value).

The total can be displayed with one or two decimal places to provide more resolution for selections that produce small values (e.g., Acre-Feet). A Scaler configuration other than one will override the decimal display.

Control group prompts

Table 4-8 lists all the function prompts in the totalizer function group.

For a 2-pen recorder, the desired input channel is displayed on the left side of the operator interface. Press **FUNC** to select channel.

Press **SETUP** key until “TOTAL” appears in the lower display.

Press **FUNC** key to select the parameters.

Table 4-8 Totalizer Function Definitions

Lower Display Prompt	Upper Display Range of Setting or Selection	Parameter Definition
(actual current totalized value)	(current scale factor) Example: E1	VIEW CURRENT TOTALIZED VALUE —This selection lets you view the current totalized value. In the example shown, E1 represents the exponential value that applies to the total (total times 10 ¹). See “SCALER” function prompt in this group for choices.
RESET	YES NO [<i>factory setting</i>]	RESET TOTALIZER TO ZERO —This parameter is used to reset the totalizer to zero. Selecting YES will reset the totalizer to zero. When the reset action has been performed, the parameter will be set to NO automatically. ATTENTION In order for this prompt to appear, the “RSTABL” function (described later in this table) must be set to “KEY”.
TOTAL	ENAB DIS [<i>factory setting</i>]	TOTALIZATION FOR INPUT —This parameter is used to enable or disable the totalizer function. This prompt appears first if “DIS” is the current choice. ENABLE allows configuration of the rest of the prompts associated with totalization.

Lower Display Prompt	Upper Display Range of Setting or Selection	Parameter Definition
INP EU	NONE <i>[factory setting]</i> CuFt GAL CuMt LITR AcFt HMTR	ENGINEERING UNITS OF INPUT SIGNAL NONE—Disables EU conversions and disables TOT EU and TOT DP functions. Cubic Feet Gallons Cubic Meters Liters Acre-Feet Hectare-Meters
RATE	SEC <i>[factory setting]</i> MIN HOUR DAY MDAY	RATE OF INTEGRATION —This parameter is used to select the desired rate of integration. SECOND —EU (Engineering Units) per second MINUTE —EU per minute HOUR —EU per hour DAY —EU per DAY MDAY —Millions of units per day
TOT EU	NONE <i>[factory setting]</i> CuFt GAL CuMt LITR AcFt HMTR	ENGINEERING UNITS OF TOTALIZED VALUE NONE—Disables EU conversions. Cubic Feet Gallons Cubic Meters Liters Acre-Feet Hectare-Meters
TOT DP	8888 <i>[factory setting]</i> 888.8 88.88	TOTALIZED VALUE DECIMAL PLACES —This parameter is used to select the number of decimal places of the displayed TOTAL value. This selection will be overridden if the SCALER selection is not equal to 1.
SCALER	1 (displays as E0) <i>[factory setting]</i> 10 (displays as E1) 100 (displays as E2) 1000 (displays as E3) 1E4 (displays as E4) 1E5 (displays as E5) 1E6 (displays as E6) 1E7 (displays as E7) 1E8 (displays as E8)	TOTALIZER SCALE FACTOR —The totalizer displays the current totalized flow value (up to six digits maximum). The scaling factor selected here is applied to the totalized value when it is displayed. 1E4 equals 1 times 10 ⁴ (10,000) 1E5 equals 1 times 10 ⁵ (100,000) 1E6 equals 1 times 10 ⁶ (1,000,000) 1E7 equals 1 times 10 ⁷ (10,000,000) 1E8 equals 1 times 10 ⁸ (100,000,000)

Lower Display Prompt	Upper Display Range of Setting or Selection	Parameter Definition
RSTABL	<p>NO <i>[factory setting]</i></p> <p>KEY</p> <p>REM1*</p> <p>REM2*</p>	<p>TOTALIZER RESETABLE—This parameter is used to specify whether and how the totalizer value can be reset.</p> <p>NO—Totalizer value cannot be reset.</p> <p>KEY—Totalizer can be reset from the keypad by setting the “RESET” parameter to “YES”.</p> <p>REM1—Totalizer will be reset when remote (external) switch (digital input 1) goes to ON (contact closure). This totalizer reset is independent of any set up of “REMSW1” in the remote switch set up group.</p> <p>REM2—Totalizer will be reset when remote (external) switch (digital input 2) goes to ON (contact closure). This totalizer reset is independent of any set up of “REMSW2” in the remote switch set up group.</p>
CUTOFF	0 % to 100 %	LOW CUTOFF VALUE —Input % of range below which the totalizer stops accumulating.

*Digital input card must be installed.

4.3.11 Control Parameters Set Up Group

Introduction

If the recorder hardware supports outputs, the functions in this group are used to configure how the recorder will control the process. (If configuring a limit controller, see Subsection 4.3.22 for special limit control configuration parameters.)

Control group prompts

Table 4-9 lists all the function prompts in the control set up group. For a 2-pen recorder, the desired input channel is displayed on the left side of the operator interface. Press **FUNC** to select channel. Press **SETUP** key until “CONTRL” appears in the lower display. Press **FUNC** key to select the parameters.

Table 4-9 Control Parameter Definitions

Lower Display Prompt	Upper Display Range of Setting or Selection	Parameter Definition
CONTRL	ENAB DIS <i>[factory setting]</i>	Enables control. Disables control. If control is disabled here, the rest of the functions in this group will not be displayed. All alarm group functions will be displayed.
NumSPs	ONE <i>[factory setting]</i> TWO	NUMBER OF SETPOINTS —If this is set to TWO, then the operator will be able to select the setpoint using the UseSPn operating parameter prompt.
OUTALG	RLY <i>[factory setting]</i> RLYD CUR CurT	OUTPUT ALGORITHM —Use to specify the type of output. RELAY SIMPLEX —Type of output using one SPDT relay. Its contacts can be wired for normally open (NO) or normally closed (NC) action. Control group function “HYST” is affected. The second relay is available for alarming, and alarm group functions will be displayed for Alarm 2. RELAY DUPLEX —Type of output using two SPDT relays. Its contacts can be wired for normally open (NO) or normally closed (NC) action. Control group function “DBAND” is affected. No relay is available for alarming, and no alarm group functions will be displayed. CURRENT SIMPLEX —Type of output using one 4 mA to 20 mA signal that can be fed to a positive or negative grounded load of 0 to 600 ohms. The current output signal can be recalibrated as described in Section 5 to use any range within 4 mA to 20 mA to represent 0 to 100 % output. CURRENT/TIME DUPLEX (Relay = Heat) —Variation of duplex with current active for 0 % to 50 % output (tuning set 2) and relay active 50 % to 100 % output (tuning set 1). Control group functions “CURRNG” and “DBAND” are affected.

Lower Display Prompt	Upper Display Range of Setting or Selection	Parameter Definition
OUTALG (continued)	Tcur	TIME/CURRENT DUPLEX (Relay = Cool) —Similar to CurT, except that current is active for 50 % to 100 % (tuning set 1) and relay is active for 0 % to 50 % (tuning set 2). Control group functions “CURRNG” and “DBAND” are affected.
CURRNG	FULL <i>[factory setting]</i> HALF	CURRENT RANGE —This parameter appears if “OUTALG” is set to “CurT” or “Tcur”. FULL —Current output is calculated over the full range 0 % to 100 %. For example, a control output of 50 % would result in a 12 mA current output. HALF —Current output is calculated over half the range (50 % to 100 %). For example, a control output of 50 % would result in a 4 mA current output.
CTRALG	ON/OFF <i>[factory setting]</i>	CONTROL ALGORITHM —Use this to specify the type of control appropriate for your application. ON/OFF is the simplest type of control. The output can be either ON (100 %) or OFF (0 %). The process variable (PV) is compared with the setpoint (SP) to determine the sign of the error (ERROR = PV–SP). The ON/OFF algorithm operates on the sign of the error. In direct-acting control (set with parameter “ACTION” described below), when the error is positive, the output is 100 %. When the error is negative, the output is 0 %. If the control action is reverse, the opposite is true. An adjustable overlap is provided between the ON and OFF states. (See “HYST” below.) DUPLEX ON/OFF is an extension of this algorithm that applies when the “OUTLAG” is set for “RLYD” (relay duplex). It allows for the operation of a second ON/OFF output. There is a configurable deadband (see “DBAND” below) between the operating ranges of the two inputs, and a separately configurable overlap (“HYST”) of the ON and OFF states of each output. With no relay action the controller output will read 50 %.

Lower Display Prompt	Upper Display Range of Setting or Selection	Parameter Definition
<p>CTRALG (continued)</p>	<p>PID A</p> <p>NOTE: PID A should not be used for proportional only action (that is, no integral (reset) action). Instead, use PDMR with "RATE T" set to 0.</p> <p>PDMR</p>	<p>PROPORTIONAL-INTEGRAL-DERIVATIVE—PID A is normally used for three-mode control. Unlike ON/OFF control, with PID A the output can be somewhere between 100 % and 0 %. PID A applies all three control actions (Proportional, Integral, and Derivative) to the error. This control can be tuned using the parameters in the tuning group.</p> <ul style="list-style-type: none"> • Proportional (gain) regulates the controller's output in proportion to the size of the error (difference between setpoint and process variable). • Integral (reset) regulates the controller's output in proportion to the size of the error and time the error has existed (duration). The amount of corrective action depends on the value of the proportional gain. • Derivative (rate) regulates the controller's output in proportion to the rate of change of the error. Again, the amount of correction depends on the gain setting. <p>PROPORTIONAL-DERIVATIVE with MANUAL RESET—Use PDMR whenever integral action is not needed during automatic control. The output is calculated with no integral contribution. Then the value specified using the tuning parameter "MANRST" (manual reset) is added to the computed output to determine the controller output. Switching between manual and auto modes will not be bumpless in PDMR.</p> <p>PDMR variations: If you select PDMR you can configure the following variations:</p> <ul style="list-style-type: none"> • PD (proportional-derivative) control, by setting MANRST to 0. • P (proportional only) control, by setting MANRST (integral term) to 0 and rate (derivative term) to 0 (tuning parameter "RATE T").
<p>PWR UP</p>	<p>MAN <i>[factory setting]</i></p> <p>AUTO</p>	<p>POWER UP CONTROLLER MODE RECALL—This selection determines which mode the recorder will use when it restarts after a power loss.</p> <p>MANUAL—At power-up, the recorder will use manual mode with the output value displayed.</p> <p>AUTOMATIC—At power-up, the recorder will return to the automatic mode.</p>
<p>DEFDSP</p>	<p>INP <i>[factory setting]</i></p> <p>SP</p>	<p>DEFAULT DISPLAY—This selection determines the default display (input or active setpoint) on power up.</p>

Lower Display Prompt	Upper Display Range of Setting or Selection	Parameter Definition
SP HI	–999 to 9999 <i>[factory setting = 100]</i>	SETPOINT HIGH LIMIT* —This selection prevents the setpoint from going above the value selected here. The setting must be equal to or less than the upper range of the input.
SP LO	–999 to 9999 <i>[factory setting = 0]</i>	SETPOINT LOW LIMIT* —This selection prevents the setpoint from going below the value selected here. The setting must be equal to or greater than the lower range of the input.
*The setpoint will automatically adjust itself to be within the setpoint limit range. For example, if SP = 1500 and SP HI is changed to 1200, the new setpoint will be 1200.		
ACTION	DIR <i>[factory setting]</i> RE	CONTROL OUTPUT DIRECTION —In what direction do you want the recorder output to go when the process variable increases. DIRECT ACTING CONTROL —The recorder's output is ON or increasing when the difference between setpoint and PV (PV–SP) is positive. REVERSE ACTING CONTROL —The recorder's output is OFF or decreasing when the difference between setpoint and PV (PV–SP) is negative.
OUT HI	0 % to 100.0 % of output for relay output –5 % to 105 % for current output <i>[factory setting = 100]</i>	HIGH OUTPUT LIMIT —This parameter is used to specify the highest output to be used in Auto mode. This prompt is displayed only if the “CTRALG” (control algorithm) is set to “PIDA” or “PDMR”.
OUT LO	0 % to 100.0 % of output for relay output –5 % to 105 % for current output <i>[factory setting = 0]</i>	LOW OUTPUT LIMIT —This parameter is used to specify the lowest output to be used in Auto mode. This prompt is displayed only if the “CTRALG” (control algorithm) is set to “PIDA” or “PDMR”.
DBAND	–5.0 % to 25.0 % <i>[factory setting = 0]</i>	DEADBAND — Use this parameter to specify an adjustable gap between the operating ranges of relay 1 and relay 2 in which neither relay operates (positive value) or both relays operate (negative value). It is the difference between the nominal trip points of relay 1 and relay 2. This prompt appears only if control group function prompt “OUTALG” is set to “RLYD”, “CurT”, or “Tcur”.
HYST	0.0 % to 5.0 % of PV span <i>[factory setting = 0]</i>	HYSTERESIS (OUTPUT RELAY ONLY) is an adjustable overlap of the ON/OFF states of each control relay. This is the difference between the value of the process variable at which the control relays energize and the value at which they de-energize. Only applicable for ON/OFF control.

Lower Display Prompt	Upper Display Range of Setting or Selection	Parameter Definition
FAILSF	0 % to 100 % <i>[factory setting = 0]</i>	FAILSAFE OUTPUT VALUE —Select the value you want the output to be when power is restored after a power down. The value used here will also be used as the output level if the input fails when input group “BRNOUT” parameter is set to “NONE”.
FSMODE	AUTO MAN	FAILSAFE MODE Failsafe Latching Disabled – When the recorder goes into “Failsafe”, the control mode does not change. The output assumes the failsafe value if the recorder is in auto mode. When the cause of failsafe is removed, normal automatic control action resumes. Failsafe Latching Enabled – When the recorder goes into “Failsafe”, the control mode changes to Manual. If the recorder was in Auto mode, the output assumes the failsafe value. When the cause of failsafe is removed, the recorder remains in manual mode.
PBorGN	PB GAIN <i>[factory setting]</i>	PROPORTIONAL BAND or GAIN —Use this parameter to choose whether you want to specify the proportional term in the PIDA or PDMR algorithms in terms of percent proportional band or of gain. Your choice here affects which tuning prompt, “PB” or “GAIN”, is displayed. This parameter is displayed only if the “CTRALG” (control algorithm) is set to “PIDA” or “PDMR”. Percent proportional band is the percent of the range of the measured variable for which a proportional-only controller will produce a 100 % change in its output. Gain is the ratio of output change (%) over the measured variable change (%) that caused it. The relationship between %PB and gain can be expressed as: $\text{GAIN} = \frac{100}{\%PB}$ For example, setting PB = 20 % will have the same effect on control as setting GAIN = 5. Therefore, if the change in the PV input were 3 % of the whole range of possible input values, then the resulting change in the output due to proportional only control would be 15 % of the output’s range, regardless of whether PBorGN = PB and PB = 20, or PBorGN = GN and GAIN = 5. Another example: Setting PB = 50 % will have the same effect as setting GAIN = 2. In this case, if the change in input were again 3 % of range, then the resulting output change would be 6 %. ATTENTION If the setting of PBorGN is changed, you must change the value of the associated tuning parameter (“PB” or “GAIN”) if you want to maintain the same control action. For example, suppose PBorGN = PB and the value of tuning parameter “PB” = 20. If you change PBorGN to GAIN, the value of tuning parameter “GAIN” will now be 20 (the value formerly assigned to “PB”). If you want the same control action you had before, you must change the value of “GAIN” to 5.

Lower Display Prompt	Upper Display Range of Setting or Selection	Parameter Definition
<p>MINRPM</p>	<p>RPM MIN <i>[factory setting]</i></p>	<p>MINUTES PER REPEAT or REPEATS PER MINUTE— Use this parameter to choose whether you want to specify the integral term (reset) in the PIDA algorithm in terms of length (minutes per repeat) or frequency (repeats per minute). Your choice here affects which tuning prompt, “I MIN” or “I RPM”, is displayed.</p> <p>The relationship between the two ways of thinking about reset is demonstrated by this example: 20 repeats per minute = 0.05 minutes per repeat.</p> <p>This parameter is displayed only if the “CTRALG” (control algorithm) is set to “PIDA”.</p> <p>ATTENTION If the setting of MINRPM is changed, you must change the value of the associated tuning parameter (“I MIN” or “I RPM”) if you want to maintain the same control action. For example, suppose MINRPM = I RPM and the value of tuning parameter “I RPM” = 2. If you change MINRPM to I MIN, the value of “I MIN” will now be 2 (the value formerly assigned to “I RPM”). If you want the same control action you had before, you must change the value of “I MIN” to 0.5.</p>

4.3.12 Tuning Parameters Set Up Group

Introduction

Tuning consists of establishing the appropriate values for tuning constants so that your recorder responds correctly to changes in process variable and setpoint. You can start with estimated values, but you will have to watch the system to judge how to modify the values. The tuning group parameters described in this subsection are available only if:

- your recorder supports control
and
- the control type specified in the control setup group using the “CTRALG” (control algorithm) parameter is “PIDA” or “PDMR”.

Two sets of PID constants

Two sets of PID constants are provided for duplex control. When the recorder is used in a heat/cool application, the first set (“PB” or “GAIN”, “RATE T”, and “I MIN” or “I RPM”) apply to heat control. The second set (“PB2” or “GAIN 2”, “RATE2T”, and “I2 MIN” or “I2 RPM”) are used for cooling control.

Accutune II

Accutune II provides foolproof, trouble-free on-demand tuning in the recorder. No knowledge of the process is required at start-up. The operator simply enters the desired setpoint and initiates the tuning. The recorder immediately starts controlling to the setpoint while it identifies the process, calculates the tuning constants and enters them into the tuning set up group, and begins PID control with the correct tuning parameters. This works with any process, including integrating type processes, and allows retuning at a fixed setpoint. The tuning sequence will cycle the recorder’s output two full cycles between 0 % and 100 % (or low and high output limits) while allowing only a very small process variable change above and below the setpoint during each cycle.

Detailed instructions for using Accutune are provided in *Appendix D*.

Fuzzy overshoot suppression

A parameter is provided to enable/disable fuzzy overshoot suppression. When enabled, fuzzy overshoot suppression minimizes process variable overshoot following a setpoint change or a process disturbance. This is especially useful in processes which experience load changes or where even a small overshoot beyond the setpoint may result in damage or lost product.

The fuzzy logic observes the speed and direction of the PV signal as it approaches the setpoint and temporarily modifies the internal controller response action as necessary to avoid an overshoot. There is no change to the PID algorithm, and the fuzzy logic does not alter the PID tuning parameters.

Tuning group prompts

Table 4-10 lists all the parameters in the tuning set up group.

For a 2-pen recorder, the desired input channel is displayed on the left side of the operator interface. Press **FUNC** to select channel.

Press **SETUP** key until “TUNING” appears in the lower display.

Press **FUNC** key to select the parameters.

ATTENTION

Appendix D contains instructions for using Accutune II for automatic tuning.

Table 4-10 Tuning Parameter Definitions

Lower Display Prompt	Upper Display Range of Setting or Selection	Parameter Definition
FUZZY	DIS [factory setting] ENAB	FUZZY OVERSHOOT SUPPRESSION FEATURE DISABLE—Disables fuzzy overshoot suppression ENABLE—The recorder will use fuzzy logic to suppress or minimize any overshoot that may occur as a result of the existing tuning parameters. It does NOT change the parameters.
TUNE	DIS [factory setting] ENAB	ACCUTUNE II —On demand tuning algorithm DISABLE—Disables ACCUTUNE II ENABLE—TuneOF will be displayed as a status message. Use the Increment or Decrement key to toggle status to TuneON. New PID parameters will be entered automatically when tuning is complete.
AT ERR	<i>no message under normal circumstances</i> <i>AbRT read only message displayed if tuning has been manually aborted</i>	ACCUTUNE II Error Code —Displays AbRT if “TUNE” has been aborted manually. <i>See Appendix D.</i>
PB or GAIN	0.1 % to 999.9 % or 0.1 to 999.9 <i>[factory setting = 1.0]</i>	PROPORTIONAL BAND or GAIN —Which of these prompts is displayed depends on the selection made for control group parameter “PBorGN” (proportional band or gain). Both proportional band and gain are ways of expressing the proportional component of control. See the description of control group parameter “PBorGN” for details concerning the two terms. ATTENTION If control group parameter “OUTALG” is “RLYD” (relay duplex), “Tcur” (time/current duplex), or “CurT” (current/time duplex), and you are using the recorder in a heat/cool application, PB or GAIN is used for heat control. Cooling control would use PB2 or GAIN 2 described later in this table.

Lower Display Prompt	Upper Display Range of Setting or Selection	Parameter Definition
RATE T	0.08 to 10.00 minutes 0.08 or less = OFF <i>[factory setting = 0.0]</i>	<p>RATE—Rate action affects the recorder's output whenever the deviation between setpoint and process variable is changing. It affects it more when the deviation is changing faster. (This is the "derivative" component of control.)</p> <p>ATTENTION If control group parameter "OUTALG" is "RLYD" (relay duplex), "Tcur" (time/current duplex), or "CurT" (current/time duplex), and you are using the recorder in a heat/cool application, RATE T is used for heat control. Cooling control would use RATE2T described later in this table.</p>
I MIN or I RPM	0.02 to 50.00 <i>[factory setting = 0.02]</i>	<p>RESET IN MINUTES PER REPEAT or RESET IN REPEATS PER MINUTE—Which of these prompts is displayed depends on the selection made for control group parameter "MINRPM".</p> <p>Reset adjusts the recorder's output taking into consideration both the size of the deviation (SP-PV) and the duration of the deviation. (This is the "integral" component of control.) The amount of corrective action depends on the value of PB or GAIN.</p> <p>The reset value specified here determines how many times proportional action is repeated per minute (I RPM) or the length (in minutes) of the reset action (I MIN). For example, if I MIN = .5, it is the same as if I RPM = 2. The result is the same; two resets are performed in every minute.</p> <p>ATTENTION If control group parameter "OUTALG" is "RLYD" (relay duplex), "Tcur" (time/current duplex), or "CurT" (current/time duplex), and you are using the recorder in a heat/cool application, I MIN or I RPM is used for heat control. Cooling control would use I2 MIN or I2 RPM described later in this table.</p>
MANRST	-100 to +100 (in % output) <i>[factory setting = 0]</i>	<p>MANUAL RESET—This parameter is only applicable if control group parameter "CTRALG" is "PDMR" (PD with manual reset). Because a proportional recorder will not necessarily line out at setpoint, there will be a deviation (offset) from setpoint. This reset value can be used to eliminate the offset and lets the PV line out at setpoint. The controller output is the computed output plus the value of MANRST.</p>

Lower Display Prompt	Upper Display Range of Setting or Selection	Parameter Definition
<p>PB2 or GAIN 2</p>	<p>0.1 % to 999.9 % or 0.1 to 999.9 [factory setting = 1.0]</p>	<p>PB2 or GAIN 2, RATE2T, and I2 MIN or I2 RPM— These parallel their counterparts already described.</p> <p>ATTENTION If control group parameter “OUTALG” is “RLYD” (relay duplex), “Tcur” (time/current duplex), or “CurT” (current/time duplex), and you are using the recorder in a heat/cool application, these parameters are used for cooling control.</p>
<p>RATE2T</p>	<p>0.08 to 10.00 minutes 0.08 or less = OFF [factory setting = 0.0]</p>	
<p>I2 MIN or I2 RPM</p>	<p>0.02 to 50.00 [factory setting = 0.02]</p>	
<p>The following parameters are used for time proportional control, and are available only if:</p> <ul style="list-style-type: none"> the control type specified in the control set up group using the “CTRALG” (control algorithm) parameter is “PIDA” or “PDMR” <p>and</p> <ul style="list-style-type: none"> the output algorithm specified in the control set up group using the “OUTALG” parameter is “RLY”, “RLYD”, “CurT”, or “Tcur”. In the case of “CurT” and “Tcur”, the cycle parameters apply only to the time-proportioned output. 		
<p>CYC TI</p>	<p>0 seconds to 120 seconds [factory setting = 4]</p>	<p>CYCLE TIMER FOR RELAY 1—Use this to specify length of total cycle time for time proportional control (proportional control using relay action rather than current output). In time proportional control the output (0 % to 100 %) signifies the portion of the cycle for which the relay is on (“duty cycle”) to achieve the desired setpoint. For example, with a 10-second cycle time and an output value of 10 %, the relay would be on for 1 second and off for 9 seconds.</p> <p>ATTENTION If control group parameter “OUTALG” is “RLYD” (relay duplex), and you are using the recorder in a heat/cool application, CYC TI is used for heat control. Cooling control would use CYC2TI.</p>
<p>CYC2TI</p>	<p>0 seconds to 120 seconds [factory setting = 4]</p>	<p>CYCLE TIMER FOR RELAY 2—This prompt will be displayed only if the control group parameter “OUTALG” is set to RLYD (relay duplex).</p> <p>ATTENTION If you are using the recorder in a heat/cool application, CYC2TI is used for control of cooling.</p>

4.3.13 Setpoint Ramp/Program Set Up Group

Introduction

All models supporting control can be configured to ramp the setpoint between the current local setpoint and a final local setpoint over a timer interval of from 1 minute to 255 minutes.

If the optional Setpoint Program feature is specified at time of purchase, then in addition to this single ramp capability, you can also configure a ramp/soak profile containing up to twelve segments, each with its own time interval.

Setpoint ramp/program group prompts

Table 4-11 lists all the function prompts in the setpoint ramp group. The additional prompts associated with the optional twelve-segment Setpoint Program are described in *Appendix C*.

For a 2-pen recorder, the desired input channel is displayed on the left side of the operator interface. Press

FUNC to select channel.

Press **SETUP** key until “SPRAMP” appears in the lower display.

Press **FUNC** key to select the parameters.

Table 4-11 Setpoint Ramp Parameter Definitions

Lower Display Prompt	Upper Display Range of Setting or Selection	Parameter Definition
SP RAMP	ENAB DIS [factory setting]	SINGLE SETPOINT RAMP — Make selection to enable or disable the setpoint ramp function. Make sure you configure a ramp time and a final setpoint value. “SP PROG” must be disabled. ENABLE SETPOINT RAMP — Allows the single setpoint ramp prompts to be shown. DISABLE SETPOINT RAMP — Disables the setpoint ramp. Allows “SPPROG” option to be selected.
TI MIN	0 minutes to 255 minutes [factory setting = 0]	SINGLE SETPOINT RAMP TIME — Enter the number of minutes desired to reach the final setpoint or a single setpoint ramp. A ramp time of “0” implies an immediate change of setpoint to the final setpoint.
FINL SP	Within SP limits [factory setting = 0]	SETPOINT RAMP FINAL SETPOINT — Enter the value desired for the final setpoint. The controller will operate at the setpoint set here when ramp is ended.
SP PROG	ENAB DIS [factory setting]	SETPOINT RAMP/SOAK PROGRAM Available only with controllers that contain this option. For reasons of convenience, the information for the prompts when SPPROG is enabled are included in <i>Appendix C</i> . ATTENTION “SP RAMP” must be disabled for SPPROG to be available.

4.3.14 Timer Set Up Group

Introduction

The timer option allows you to configure a timeout period and to select the timer start by either the keyboard (Increment or Decrement key) or Alarm 1. The optional digital input can also be configured to the start the timer. The timer display is selectable as either “time remaining” or “elapsed time”.

Alarm 2 is activated at the end of the timeout period. When the timer is enabled, it has exclusive control of the Alarm 2 relay; any previous Alarm 2 configuration is ignored. At timeout, the timer is ready to be activated again by whatever action has been configured. Relay 2 will remain energized until the timer is reset.

See Subsection 4.5.2.7 for operation of timer.



Timer group prompts

Table 4-12 lists all the function prompts in the timer setup group and their definitions.

Press **[SET UP]** key until “TIMER” appears in the lower display.

Press **[FUNC]** key to display parameters.

Table 4-12 Timer Parameter Definitions

Lower Display Prompt	Upper Display Range of Setting or Selection	Parameter Definition
TIMER	ENAB DIS <i>[factory setting]</i>	TIMER - Use this to enable or disable the timer option.
PERIOD	0:00 to 99:59 <i>[factory setting = 0]</i>	PERIOD - Configure the length of the timeout period (from 0 to 99 hours, 59 minutes).
START	KEY <i>[factory setting]</i> AL1	START - Select whether the Timer starts with the keyboard (Increment or Decrement key) or Alarm 1.
L DISP	TREM <i>[factory setting]</i> ET	<p>L DISP - Select whether time remaining (TREM) or elapsed time (ET) is displayed for the timer option.<i>r</i></p> <p>The time is shown on the lower display in hh:mm format along with a rotating “clock” character.</p> <p>Time remaining: If the “clock” rotation is clockwise, elapsed time is indicated.  □.□□</p> <p>Elased time: If the “clock” rotation is counterclockwise, time left is indicated.  □.□□</p>

4.3.15 Alarms Set Up Group

Introduction

If the recorder hardware supports outputs, one or both relays can be used for alarming. An alarm is an indication that an event that you have selected during configuration (process variable, for example) has exceeded one or more alarm limits. There are two alarms available for each pen (assuming no relay is being used for control). Each alarm has two setpoints. There are two alarm output selections, high and low.

You can configure each setpoint to alarm either high or low. Each alarm has an adjustable hysteresis of 0.0 % to 100.0 % that is configurable for that alarm's setpoint.

If the "OUTALG" function in the control group is set to "RLYD", both relays on the printed circuit assembly for the pen being configured are used for control, and the prompts in the alarm group will not be displayed. If "OUTALG" is "RLY", or if the recorder is a limit controller, then Relay 1 is used for control. In these cases only the prompts for the second alarm (Relay 2) will be displayed.

If "TIMER" is set to "ENAB", then Relay 2 is used by the timer and prompts for the second alarm will not be displayed.

Alarms group prompts

Table 4-13 lists all the function prompts in the alarms set up group and their definitions.

For a 2-pen recorder, the desired input channel is displayed on the left side of the operator interface.

Press **FUNC** to select channel.

Press **SETUP** key until "ALARMS" appears in the lower display.

Press **FUNC** key to select the parameters.

Table 4-13 Alarm Parameter Definitions

Lower Display Prompt	Upper Display Range of Setting or Selection	Parameter Definition
A1S1TY*	NONE [factory setting] INP DEV	ALARM 1 SETPOINT 1 TYPE —Select what you want Setpoint 1 of Alarm 1 to represent. NO ALARM INPUT PV DEVIATION of input from setpoint
A1S2TY*	Same as A1S1TY	ALARM 1 SETPOINT 2 TYPE —Select what you want Setpoint 2 of Alarm 1 to represent. The selections are the same as A1S1TY.
*For Deviation Alarm to function: control must be enabled. If On/Off control is selected, only alarm #2 is available for Deviation.		
A1S1VA	–999 to 9999 [factory setting = 100]	ALARM 1 SETPOINT 1 VALUE —This is the value at which you want the alarm type chosen in prompt "A1S1TY" to actuate. The appropriate value depends on what the setpoint has been configured to represent.
A1S2VA	–999 to 9999 [factory setting = 100]	ALARM 1 SETPOINT 2 VALUE —This is the value at which you want the alarm type chosen in prompt "A1S2TY" to actuate. The appropriate value depends on what the setpoint has been configured to represent.
A1S1HL	HI LO [factory setting]	ALARM 1 SETPOINT 1 STATE —Select whether you want the alarm type chosen in prompt "A1S1TY" to alarm high or low. HI ALARM —Relay coil is de-energized when the PV is above the setpoint. LO ALARM —Relay coil is de-energized when the PV is below the setpoint.

Lower Display Prompt	Upper Display Range of Setting or Selection	Parameter Definition
A1S2HL	HI <i>[factory setting]</i> LO	ALARM 1 SETPOINT 2 STATE —Select whether you want the alarm type chosen in prompt "A1S2TY" to alarm high or low. HI ALARM —Relay coil is de-energized when the PV is above the setpoint. LO ALARM —Relay coil is de-energized when the PV is below the setpoint.
A1 HYS	0.0 % to 100.0 % of input span <i>[factory setting = 0]</i>	ALARM 1 HYSTERESIS —This is an adjustable hysteresis provided on alarm 1 that activates at exactly the alarm setpoint when the alarm is OFF. When the alarm is ON, it will not deactivate until the variable is away from the alarm setpoint by a value equal to A1 HYS. Configure the hysteresis as a percent of input range span.
A2S1TY	Same as A1S1TY	ALARM 2 SETPOINT 1 TYPE —Select what you want Setpoint 1 of Alarm 2 to represent. The selections are the same as "A1S1TY".
A2S2TY	Same as A1S1TY	ALARM 2 SETPOINT 2 TYPE —Select what you want Setpoint 2 of Alarm 2 to represent. The selections are the same as "A1S1TY".
A2S1VA	-999 to 9999 <i>[factory setting = 100]</i>	ALARM 2 SETPOINT 1 VALUE —This is the value at which you want the alarm type chosen in prompt "A2S1TY" to actuate. The appropriate value depends on what the setpoint has been configured to represent.
A2S2VA	-999 to 9999 <i>[factory setting = 100]</i>	ALARM 2 SETPOINT 2 VALUE —This is the value at which you want the alarm type chosen in prompt "A2S2TY" to actuate. The appropriate value depends on what the setpoint has been configured to represent.
A2S1HL	HI LO <i>[factory setting]</i>	ALARM 2 SETPOINT 1 STATE —Select whether you want the alarm type chosen in prompt "A2S1TY" to alarm high or low. HI ALARM —Relay coil is de-energized when the PV is above the setpoint. LO ALARM —Relay coil is de-energized when the PV is below the setpoint.
A2S2HL	HI <i>[factory setting]</i> LO	ALARM 2 SET POINT 2 STATE —Select whether you want the alarm type chosen in prompt "A2S2TY" to alarm high or low. HI ALARM —Relay coil is de-energized when the PV is above the setpoint. LO ALARM —Relay coil is de-energized when the PV is below the setpoint.
A2 HYS	0.0 % to 100.0 % of input span <i>[factory setting = 0]</i>	ALARM 2 HYSTERESIS —This is an adjustable hysteresis provided on alarm 2 that activates at exactly the alarm setpoint when the alarm is OFF. When the alarm is ON, it will not deactivate until the variable is away from the alarm setpoint by a value equal to A2 HYS. Configure the hysteresis as a percent of input range span.

4.3.16 Auxiliary Output Set Up Group

Introduction

The auxiliary output set up group lets you enable or disable the auxiliary output selection which provides a milliampere output representing one of four control parameters: Input, Output, Setpoint, or Deviation. You can also set the auxiliary output low and high scaling factors.

Auxiliary output group prompts

Table 4-14 lists all the function prompts in the auxiliary output set up group and their definitions.

For a 2-pen recorder, the desired input channel is displayed on the left side of the operator interface.

Press **FUNC** to select channel.

Press **SETUP** key until “AUX OUT” appears in the lower display.

Press **FUNC** key to select the parameters.

Table 4-14 Auxiliary Output Parameter Definitions

Lower Display Prompt	Upper Display Range of Setting or Selection	Parameter Definition
AUXOUT	NONE <i>[factory setting]</i> INP OUT SP	<p>AUXILIARY OUTPUT SELECTION provides an mA output representing any of four control parameters. The display for Auxiliary Output viewing will be in engineering units for all but output. Output will be designated in percent (%).</p> <p>The Auxiliary Output is the same output as the Current Output and is <i>not</i> available if the control output algorithm = CUR, CurT, or Tcur.</p> <p>Other prompts affected by these selections: “4 mA VAL” and “20mA VAL”.</p> <p>NO AUXILIARY OUTPUT</p> <p>INPUT—This represents the configured range of input. FOR EXAMPLE: Type “J” Thermocouple (0 °F to 1600 °F) 0 °F display = 0 % output 1600 °F display = 100 % output</p> <p>OUTPUT—Represents the displayed controller output in percent (%).</p> <p>SETPOINT—Represents the value of the setpoint in units of PV.</p>

Lower Display Prompt	Upper Display Range of Setting or Selection	Parameter Definition
AUXOUT (continued)	DE	<p>DEVIATION (Process Variable minus Setpoint)—Represents –100 % to +100 % of the selected PV span in engineering units. FOR EXAMPLE:</p> <p style="padding-left: 40px;">Type “T” Thermocouple PV range = –300 °F to +700 °F PV span = 1000 °F Deviation range = –1000 °F to +1000 °F If PV = 500 °F and SP = 650 °F then Deviation Display = –150 °F Auxiliary Output = 42.5 %</p> <p>NOTE: A deviation of 0°F yields an auxiliary output of 50 %.</p>
4mA VA	<p>Low Scale Value within the range of the selected variable to represent 4 mA</p> <p><i>[factory setting = 0]</i></p>	<p>AUXILIARY OUTPUT LOW SCALING FACTOR—Use a value in engineering units for all selections above except Output.</p> <p>Use value in percent (%) for Output. (Output can be between –5 % and +105 %.)</p>
20mA V	<p>High Scale Value within the range of the selected variable to represent 20 mA</p> <p><i>[factory setting = 100]</i></p>	<p>AUXILIARY OUTPUT HIGH SCALING FACTOR—Use a value in engineering units for all selections above except Output.</p> <p>Use a value in percent (%) for Output. (Output can be between –5 % and +105 %.)</p> <p>*When Deviation is selected, only one operating parameter will be entered. This value represents the deviation level that will produce 20 mA output. Zero deviation will produce a center scale (12 mA) output. A negative deviation equal in magnitude to the Auxiliary Output High Value will provide a low end (4 mA) output.</p>

4.3.17 Communication Set Up Group

Introductions

If the hardware supports the Modbus communication option, use the prompts in the communication set up group to configure communication parameters.

Communication group prompts

Table 4-15 lists the function prompt in the communication set up group.

For a 2-pen recorder, the desired input channel is displayed on the left side of the operator interface. Press **FUNC** to select channel.

Press **SETUP** key until “COMM” appears in the lower display.

Press **FUNC** key to select the parameter.

ATTENTION

Each pen channel must have its own unique address. However, set the same baud rate and transmitter delay for both pens.

Table 4-15 Communication Parameter Definitions

Lower Display Prompt	Upper Display Range of Setting or Selection	Parameter Definition
COMM	DIS <i>[factory setting]</i> ENAB	COMMUNICATION ENABLE —Enable/disable communication.
ADDRES	1 to 99 <i>[factory setting = 0]</i>	ADDRESS —Specify the pen channel's address on the network.
BAUD	300 600 1200 2400 4800 9600 <i>[factory setting]</i> 192K	BAUD RATE —Specify the baud rate used by all devices on the network.
XmtDLY	NONE <i>[factory setting]</i> 10ms 20ms 30ms 40ms 50ms	TRANSMITTER DELAY —Specify the minimum delay between the end of a received message and the start of the response message.
DBLBYT	FP B FP BB FP L FP LB	DOUBLE BYTE ORDER —Determines Floating Point Byte order in Modbus queries. Big Endian Big Endian – Byte Swapped Little Endian Little Endian – Byte Swapped

4.3.18 Remote Switch (Digital Inputs) Set Up Group

Introduction

If the hardware supports optional digital inputs, the parameters in this group are used to specify what action the recorder will take if these “remote switches”, triggered by some external event, are closed.

Remote switch group prompts

Table 4-16 lists all the function prompts in the remote switch set up group and their definitions. For a 2-pen recorder, the desired input channel is displayed on the left side of the operator interface.

Press **FUNC** to select channel.

Press **SETUP** key until “REM SW” appears in the lower display.

Press **FUNC** key to select the parameters.

Table 4-16 Remote Switch Parameter Definitions

Lower Display Prompt	Upper Display Range of Setting or Selection	Parameter Definition
REMSW1	NONE <i>[factory setting]</i> SP2 MAN MNFS HOLD RUN TIMR	<p>REMOTE SWITCH 1—Use this parameter to specify what action the recorder should take if digital input 1 for this channel goes to ON (switch contact closed).</p> <p>NONE—No remote switching action.</p> <p>SETPOINT2—Controller setpoint used in Auto will go to the value of the second setpoint (operating parameter “S2” for the channel) when the digital input goes ON. (When it goes OFF, the recorder will resume using “SP” for the channel.)</p> <p>Use of the second setpoint with a remote switch is independent of the number of setpoints specified with control group parameter “NumSPs”.</p> <p>MANUAL—Controller will be switched to Manual mode when the digital input goes ON. Output will not change until the operator changes it. (When the digital input goes OFF, the controller will go back to Auto, using operating parameter “SP” as the basis of computing output.)</p> <p>MANUAL WITH FAILSAFE—Controller will be switched to Manual mode <u>and</u> the output will be changed to the value of control group parameter “FAILSF” for the channel when the digital input goes ON. (When the digital input goes OFF, the controller will go back to Auto, using operating parameter “SP” as the basis of computing output.)</p> <p>HOLD—When the digital input goes ON, the recorder will hold execution of the single setpoint ramp or the optional setpoint program.</p> <p>RUN—When the digital input goes ON, the recorder will start execution of the single setpoint ramp or the optional setpoint program.</p> <p>TIMER—When the digital input goes ON, the optional timer will start.</p>
REMSW2	NONE <i>[factory setting]</i> SP2 MAN MNFS HOLD RUN TIMR	<p>REMOTE SWITCH 2—This parameter is used to specify what action the recorder should take if digital input 2 for this channel goes ON (switch contact closed). The choices are the same as for REMSW1.</p>

4.3.19 Display Parameter Set Up Group

Introduction

Using the BLANK function, the display can be set to turn off a configured number of seconds after the last press of any key. Pressing any key while the display is blank will restore it.

When the TOGGLE function is enabled, the pen currently driving the display will switch control to the other pen after a configured timeout period. If the other pen has its TOGGLE function enabled, it will switch back after its configured timeout period.

Lockout group prompts

Table 4-17 lists the function prompt in the lock out set up group.

For a 2-pen recorder, the desired input channel is displayed on the left side of the operator interface. Press **FUNC** to select channel.

Press **SETUP** key until “DSPLAY” appears in the lower display.

Press **FUNC** key to select the parameter.

Table 4-17 Display Parameter Definitions

Lower Display Prompt	Upper Display Range of Setting or Selection	Parameter Definition
BLANK	OFF <i>[factory setting]</i> 2s 4s . . . 30s	BLANKING FUNCTION —Use this parameter to set timeout period after which the display goes blank. OFF disables the function.
TOGGLE	OFF <i>[factory setting]</i> 2s 4s . . . 30s	TOGGLE FUNCTION —Use this parameter to set the timeout period after which control the display is passed to the other board (pen).

4.3.20 Lock Out Parameter Set Up Group

Introduction

This is the parameter used to lockout any unauthorized changes to the recorder's configuration, calibration, and pen alignment parameters. Calibration group functions are described in *Section 5 – Input and Output Calibration for Recorder with Display*. Pen alignment group functions are described in *Section 8 – Troubleshooting and Pen Alignment for Recorder with Display*.

Set this group last

Because this group contains functions that have to do with security and lockout, we recommend that you configure this group last, after all the other configuration data has been entered.

Lockout group prompts

Table 4-18 lists the function prompt in the lock out set up group.

Press **SETUP** key until "LOCK" appears in the lower display.

Press **FUNC** key to select the parameter.

Table 4-18 Lockout Parameter Definitions

Lower Display Prompt	Upper Display Range of Setting or Selection	Parameter Definition
LOCK		LOCK limits access to one or more types of set up groups. Do not configure until all configuration is complete.
	NONE [factory setting]	NO LOCKOUT —All groups read/write.
	CAL	CAL —Locks out calibration and pen alignment groups; they will not even be displayed. All other groups are available for read/write.
	CONF	CONF —Tuning and cycle parameters are read/write. All other configuration groups (except lock) are read only. Calibration and pen alignment groups are not displayed.
	FULL	FULL — All configuration groups (except lock) are read only. Calibration and pen alignment groups are not displayed.

ATTENTION

The Lock function cannot be changed when the RUN/SETUP switch is in the "SETUP" position, making it usable as a physical lockout. Whatever lockout level is selected, it is protected as long as the switch is in the SETUP position.

4.3.21 Configuration Record Sheet

Keep a record

Enter the value or selection for each prompt on the configuration record sheet. Remember that not all function parameters apply to every recorder and configuration. See *Appendix C* for a special worksheet used for 24-segment setpoint program.

NAME _____

Group Prompt	Function Prompt	Pen 1 Value or Selection	Pen 2 Value or Selection	Group Prompt	Function Prompt	Pen 1 Value or Selection	Pen 2 Value or Selection	
INPUT	DECIMAL	_____	_____	TUNING (cont'd)	I MIN or I RPM	_____	_____	
	UNITS	_____	_____		MANRST	_____	_____	
	IN TYP	_____	_____		PB2 or GAIN 2	_____	_____	
	XMITTR	_____	_____		RATE2T	_____	_____	
	LD CAL	_____	_____		I2 MIN or I2 RPM	_____	_____	
	INP HI	_____	_____		CYCT1	_____	_____	
	INP LO	_____	_____		CYCTI2	_____	_____	
	BIAS	_____	_____		SPRAMP	SPRAMP	_____	_____
	FILTER	_____	_____			TI MIN	_____	_____
BRNOUT	_____	_____	FINLSP	_____		_____		
PEN	PEN IN	_____	_____	SPPROG	_____	_____		
	CHT HI	_____	_____	TIMER	TIMER	_____	_____	
CHT LO	_____	_____	PERIOD		_____	_____		
CHART	CHTSPD	_____	n/a		START	_____	_____	
	HR/REV	_____	n/a	L DISP	_____	_____		
TOTAL	CHTTYT	_____	n/a	ALARMS	A1S1TY	_____	_____	
	[value]	_____	_____		A1S2TY	_____	_____	
RESET	_____	_____	A1S1VA		_____	_____		
TOTAL	_____	_____	A1S2VA		_____	_____		
INP EU	_____	_____	A1S1HL		_____	_____		
RATE	_____	_____	A1S2 HL		_____	_____		
TOT EU	_____	_____	A1 HYS		_____	_____		
TOT DP	_____	_____	A2S1TY		_____	_____		
SCALER	_____	_____	A2S2TY		_____	_____		
RSTABL	_____	_____	A2S1VA		_____	_____		
CONTROL	CONTRL	_____	_____		A2S2VA	_____	_____	
	NumSPs	_____	_____		A2S1HL	_____	_____	
	OUTALG	_____	_____		A2S2HL	_____	_____	
	CURRNG	_____	_____		A2 HYS	_____	_____	
	CTRALG	_____	_____		AUXOUT	AUXOUT	_____	_____
	PWR UP	_____	_____	4mA VA		_____	_____	
	DEFDSP	_____	_____	20mA V		_____	_____	
	SP HI	_____	_____	COMM	COMM	_____	_____	
	SP LO	_____	_____		ADDRES	_____	_____	
	ACTION	_____	_____		BAUD	_____	_____	
OUT HI	_____	_____	XmtDLY	_____	_____			
OUT LO	_____	_____	DBLBYT	_____	_____			
DBAND	_____	_____	REM SW	REMSW1	_____	_____		
HYST	_____	_____		REMSW2	_____	_____		
FAILSF	_____	_____	DSPLAY	BLANK	_____	_____		
PBorGN	_____	_____		TOGGLE	_____	_____		
MINRPM	_____	_____	LOCK	LOCK	_____	_____		
FUZZY	_____	_____						
TUNE	_____	_____						
AT ERR	_____	_____						
PB or GAIN	_____	_____						
RATE T	_____	_____						

4.3.22 Limit Control Configuration

Special configuration for control and alarms

The DR4300 is available as a limit controller. Most set up groups described in Subsections 4.3.7 through 4.3.20 apply to limit control, and are configured for the limit controller the same way they are for other recorders.

The exceptions are:

- Control set up group contains special parameters for limit control in place of those described in Subsection 4.3.11. The limit control set up parameters that replace those in Subsection 4.3.11 are listed in Table 4-19.
- Alarm 1 is not available.

Table 4-19 Limit Control Parameter Definitions

Lower Display Prompt	Upper Display Range of Setting or Selection	Parameter Definition
LIMIT	HI LO <i>[factory setting]</i>	TYPE OF LIMIT CONTROL HI — Limit action occurs when PV exceeds SP. LO — Limit action occurs when PV is less than SP.
POWRUP	NORM RST <i>[factory setting]</i>	POWER UP STATE NORM — Normal limit control on power up. RST — Powers up in limit state. Recorder will not begin normal limit control until RESET key is pressed.*
SP HI	–999 to 9999 <i>[factory setting = 100]</i>	SETPOINT HIGH RANGE LIMIT —This parameter prevents the local setpoint from going above the value specified here. The setting must be equal to or less than the upper range of the input.
SP LO	–999 to 9999 <i>[factory setting = 0]</i>	SETPOINT LOW RANGE LIMIT —This parameter prevents the local setpoint from going below the value specified here. The setting must be equal to or greater than the lower range of the input.
XRSET	DIS <i>[factory setting]</i> ENAB	EXTERNAL RESET —Use this parameter to enable or disable resetting the limit controller (taking it out of the limit state) using Remote Switch 1 (digital input 1). DIS — When external reset is disabled, the limit controller can be reset only by pressing the MAN/AUTO/RESET key on the recorder. ENAB — When external reset is enabled, the limit controller can be reset two ways: by pressing the MAN/AUTO/RESET key on the recorder, or by turning on digital input 1 (contact closed).

4.4 Startup of Recorder with Display and Keypad

4.4.1 Overview

Introduction

This subsection provides procedures and reference information for startup and operation of a recorder having a display and keypad. (For information on operating a recorder that does not have a display and keypad, see Section 3.) This subsection assumes that the recorder has been properly prepared, mounted, and wired in accordance with the instructions in Section 2, and configured as described earlier in this section.

Some of the procedures in this subsection are required only initially; some are required during use. Once the recorder is up and running, operator actions are required infrequently.



WARNING—SHOCK HAZARD



STARTUP AND MAINTENANCE MAY REQUIRE ACCESS TO HAZARDOUS LIVE CIRCUITS, AND SHOULD ONLY BE PERFORMED BY QUALIFIED SERVICE PERSONNEL. MORE THAN ONE SWITCH MAY BE REQUIRED TO DE-ENERGIZE UNIT BEFORE SERVICING.

4.4.2 Preparing the Recorder for Startup

Introduction

Before applying power to the recorder, complete these preparation tasks.

ATTENTION

Never move the pen arms when the unit is operating unless adjusting the pen alignment as described in Section 8.

WARNING



SHOCK HAZARD

When the unit is powered a potentially lethal shock hazard exists at the AC line connections at TB1 on each printed circuit assembly (behind the chart plate). Make sure the unit power is disconnected before starting the procedure. More than one switch may be required to de-energize the recorder.

Failure to observe this precaution can result in exposure to a potentially lethal shock hazard.

Procedure

Refer to Figure 4-4 to identify the basic chart plate components and follow the procedure in Table 4-20 to prepare the recorder for operation.

Table 4-20 Preparing the Recorder for Operation

Step	Action
1	Open the door of the recorder.
2	Pull up on the pen lifter to raise the pen(s) from the chart plate and remove the protective cap from each pen tip. Lift the locking clip on the chart hub.
3	Slip the new chart under the pen lifter, pen and time index, and press it into place over the chart hub.
4	Turn the chart until the desired time line on the chart is aligned with the time index on the chart plate and pen 1 before closing the locking clip on the hub. Push down on the lifter to return the pen(s) to the chart. CAUTION: Do not try to rotate the hub

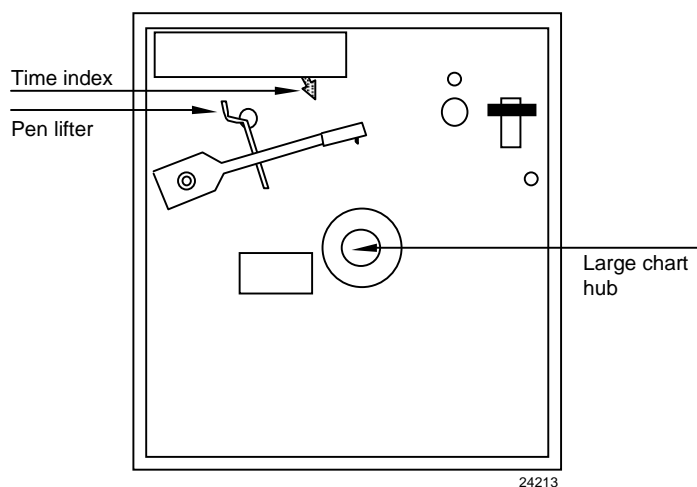

Figure 4-4 Basic Chart Plate Components

4.4.3 Running the Optional Step Test

Introduction

You can test the recorder's mechanical operation by running a step test. This test is initiated using the keypad as described in Table 4-21.

This test prints a step pattern, which is independent of any chart settings, with horizontal lines drawn by both pens at each 10 % increment on the chart (see Figure 4-5).

WARNING



SHOCK HAZARD

When the unit is powered a potentially lethal shock hazard exists at the AC line connections at TB1 on each printed circuit assembly (behind the chart plate). Make sure the unit power is disconnected before starting the procedure. More than one switch may be required to de-energize the recorder.

Failure to observe this precaution can result in exposure to a potentially lethal shock hazard.

The test will run for one complete revolution of the chart before it stops itself. The chart revolution for the test takes approximately 2 minutes, regardless of configured chart speed. However, the test can be terminated at any time by pressing the **DISP** key.

Additional automatic self-tests

At power-up the recorder runs self-diagnostics on the printed circuit assembly for each pen. See Section 0 and *Section 8 – Troubleshooting and Pen Alignment of Recorder with Display* for more information about these diagnostic tests.

Procedure

Use the procedure in Table 4-21 to run the step test.

Table 4-21 Procedure for Running the Step Test

Step	Press	Action/Result
1		Make sure the cap is removed from the tip of each pen and the chart is installed. (If you plan to store or ship the recorder, save the protective caps for the pen tips. Replace them if the recorder is taken out of operation.)
2		Being careful of the shock hazard at TB1 , swing out the chart plate and set SW5 on the printed circuit assembly on the right (pen 1) to the setup position, toward the top of the board. Be certain that the Lockout level is "CAL" or "NONE". The self-test will not run otherwise.
3		Apply power to the recorder.
4	FUNC	Until INP 1 indicator is lit on the left side of the operator interface.

Step	Press	Action/Result
5	<p>DISP</p> <p>and</p> <p>MAN AUTO RESET</p> <p>together</p>	<p>You will see:</p> <p>Upper Display <div style="border: 1px solid black; padding: 2px; display: inline-block;">PASS</div></p> <p>Lower Display <div style="border: 1px solid black; padding: 2px; display: inline-block;">SLF TST</div></p> <p><i>Refer to Section 8 if step test fails.</i></p>
6		<p>Check to see that the recorder is generating a step pattern on the chart as shown in Figure 4-5.</p> <p>At the completion of the test (after one revolution of the chart), the recorder will automatically return to normal operation.</p>
7	<p>FUNC</p>	<p>Lights INP 2 indicator (if recorder has 2 pens)</p> <p>You will see:</p> <p>Upper Display <div style="border: 1px solid black; padding: 2px; display: inline-block;">(value)</div></p> <p>Lower Display <div style="border: 1px solid black; padding: 2px; display: inline-block;">INP</div></p> <p>Repeat Steps 4 and 5 to test pen 2 operation.</p>
8	<p>DISP</p>	<p>Terminates the test at any time.</p>

Chart step pattern

Figure 4-5 is a typical chart step pattern generated by the recorder in the test.

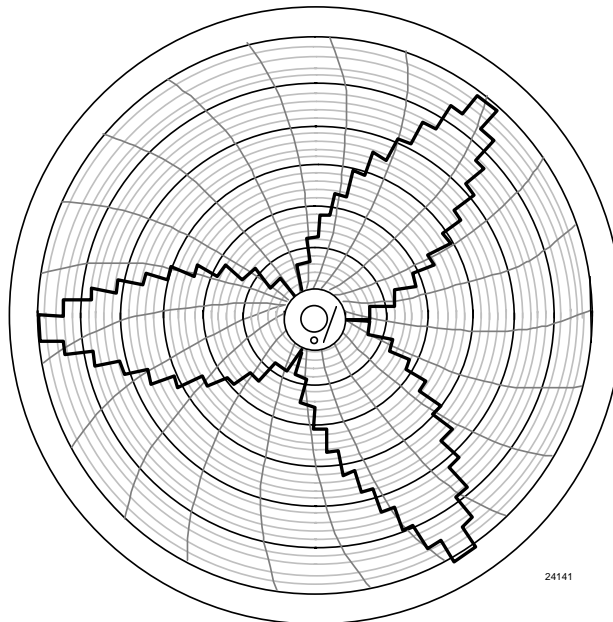

Figure 4-5 Typical Step Test Chart Patterns

4.4.4 Completing Preparation and Startup

4.4.4.1 Overview

Introduction

Once the recorder is set up, mounted, wired, and the chart has been installed, the only remaining tasks are:

- setting the chart time and applying the power (see Subsection 4.4.4.2)
- checking the self-diagnostic tests (see Subsection 4.4.4.3)
- checking the displays and keys (see Subsection 4.4.4.4)
- starting operation (see Subsection 4.4.4.5)

4.4.4.2 Set chart time and apply power

Procedure

To set the chart time and apply power, follow the procedure in Table 4-18. (See also Figure 4-6.)

Table 4-22 Procedure for Setting Chart Time and Applying Power

Step	Action
1	Open the door.
2	Pull up the pen lifter to raise the pen(s) from the chart plate. Lift locking clip on the chart hub.
3	Turn the chart until the desired time line on the chart is aligned with the time index on the chart plate and pen 1 before closing the locking clip on the hub. Push down on the lifter to return the pen(s) to the chart. CAUTION: Do not try to rotate the hub.
4	Close the door and apply power.
5	The pen(s) will move into position and the recorder pen will start to track the value specified using the "PENIN" parameter in the pen set up group (see Subsection 4.3.8).

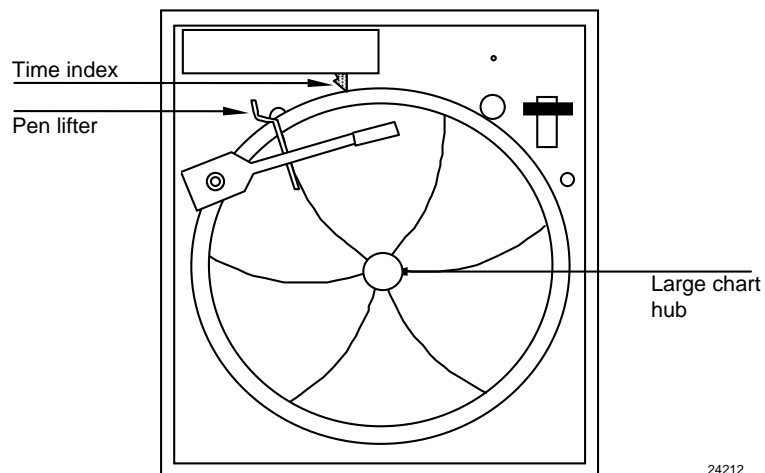

Figure 4-6 Setting Chart Time to Time Index

4.4.4.3 Diagnostic tests

Tests run automatically

When the recorder is powered-up, self-diagnostics are run by the software.

As the tests in Table 4-23 are run, the display indicates whether the tests were passed or failed as described below.

Table 4-23 Power-Up Diagnostic Tests

Lower Display	Upper Display
RAMTST	PASS or FAIL
CFGTST (configuration checksum)	PASS or FAIL
CALTST (working calibration)	PASS or FAIL

Status of tests displayed

As the tests are run, the lower line of the display shows which test is running. The upper line of the display indicates the status. If any of these tests fail, "FAIL" appears momentarily in the upper display, then a display test is run. The display changes to show the value of the process variable on the top line, and the error message for the failed test on the second line.

In addition, if the control group parameter "CONTRL" has a value of "ENAB" when the test is failed, the message "FAILSF" (failsafe) will alternate with error message for the test, and the controller will be in manual mode. When the "FAILSF" message is displayed, it indicates that the recorder control output has been driven to the value assigned to the control group "FAILSF" parameter.

By default, when the recorder is powered up the display will be for pen 1. Therefore, when the power up tests run, the "PASS" and "FAIL" messages will apply only to the printed circuit assembly associated with pen 1. However, in a 2-pen recorder the tests will also be run on the printed circuit assembly for pen 2. If the pen 2 assembly fails one of the tests, the message "P2 ERR" will be displayed, along with any error messages from the pen 1 tests.

Section 8 contains additional information about self-diagnostics, and suggested remedies if a problem is detected.

4.4.4.4 Check the displays and keys

Procedure

Use the procedure in Table 4-24 to run the optional display and key test.

Table 4-24 Procedure for Testing the Displays and Keys

Press	Result														
<p style="text-align: center;"> <div style="border: 1px solid black; padding: 2px; display: inline-block; margin-bottom: 5px;">SET UP</div> and hold in, then <div style="border: 1px solid black; padding: 2px; display: inline-block; margin-top: 5px;">FUNC</div> at the same time </p>	<p>The recorder runs a display test. All the displays will light for 10 seconds, then the displays will look like this:</p> <p>Upper Display <div style="border: 1px solid black; padding: 2px; display: inline-block; margin-left: 20px;">KEYS</div></p> <p>Lower Display <div style="border: 1px solid black; padding: 2px; display: inline-block; margin-left: 20px;">TRY</div></p>														
<p>Press each key to see if it works</p>	<p>When the key is pressed, the lower display indicates the name of the key pressed.*</p> <table border="1" data-bbox="626 863 1386 1108"> <thead> <tr> <th>Key Pressed</th> <th>Lower Display</th> </tr> </thead> <tbody> <tr> <td>SET UP</td> <td>SET</td> </tr> <tr> <td>FUNC</td> <td>FUNC</td> </tr> <tr> <td>DISP</td> <td>DISP</td> </tr> <tr> <td>MAN/AUTO/RESET</td> <td>AUTO</td> </tr> <tr> <td>▲</td> <td>INCR</td> </tr> <tr> <td>▼</td> <td>DECR</td> </tr> </tbody> </table> <p>If pressing a key does not display its name, the display/keypad assembly is defective. Replace it as described in <i>Section 9 – Replacing Hardware Assemblies</i>.</p>	Key Pressed	Lower Display	SET UP	SET	FUNC	FUNC	DISP	DISP	MAN/AUTO/RESET	AUTO	▲	INCR	▼	DECR
Key Pressed	Lower Display														
SET UP	SET														
FUNC	FUNC														
DISP	DISP														
MAN/AUTO/RESET	AUTO														
▲	INCR														
▼	DECR														

* If no key is pressed for 30 seconds, the test times out and the recorder exits the key test.

Key Error message

When a key is pressed and the prompt “KEY ERROR” appears in the lower display, the message is not associated with the display and keypad test. This message will be displayed when the operator presses a key that is invalid for the recorder’s configuration. The “KEY ERROR” message will be displayed during normal operation if one of the following conditions is met.

- The parameter normally called up by the key is not available.
- The recorder is not in Set Up mode, so the recorder can not respond to the key; press the SET UP key first.
- The key is not valid because the recorder is not set up for control.
- The key malfunctions; perform keypad test.

4.4.4.5 Startup procedure

Procedure

Use the procedure listed in Table 4-25 to start the recorder.







Open the recorder door (if the recorder does not have the optional keypad on the outside of the door).
Apply power and wait for the recorder to run its power-up tests.



ATTENTION

If FAILSF or another error message starts blinking in the lower display, refer to Section 8 for troubleshooting information.

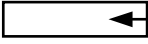
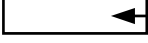
For recorders with control on both pens, be sure the INP '1' indication is lit for steps 2 to 6. If INP 1 is not lit, press the **FUNC** key until "1" is lit when "INP" is displayed.

Table 4-25 Procedure for Starting the Recorder

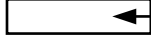
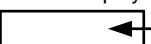
Step	Operation	Press	Action/Result
1	Pen check		For models without outputs, check that the pen is operating and skip to Step 4.
2	Select manual mode		Until "M" indicator is ON. Be sure INP 1 indicator is lit. If it is not, press FUNC key. The recorder is in manual mode and the Output (OT) in percent is displayed in the lower display.
			Calls up OT value in the lower display.
3	Adjust the output	 or 	Adjust the output value and ensure that the final control element is functioning correctly. Upper Display  shows the input value. Lower Display  shows OT and the output value in %.
4	Confirm correct configuration.		If you want to check the recorder's configuration, follow the procedure described earlier in this section. If you try to change a value and can not, a lockout is enabled; see Subsection 4.3.19.

Step	Operation	Press	Action/Result
5	Enter the setpoint	<div style="border: 1px solid black; padding: 5px; display: inline-block;">DISP</div> until	Upper Display  shows the input (PV) value. Lower Display  SP and the setpoint value for the selected channel.
		 or 	Adjust the setpoint to the value at which you want the process variable maintained.
6	Select automatic mode	<div style="border: 1px solid black; padding: 5px; display: inline-block;">MAN AUTO RESET</div>	Until "A" indicator is ON. The recorder is in Automatic mode. The recorder will automatically adjust the output to maintain the process variable at setpoint as tracked by the pen trace.
7	Start up Controller #2	<div style="border: 1px solid black; padding: 5px; display: inline-block;">FUNC</div>	Until INP 2 indicator on left side of display is lit. For recorders with two control outputs enabled, repeat steps 2 to 6 for the second control output, but be sure INP "2" indicator is lit instead of INP "1".
8	Exit Startup		Close the door and monitor the operation.

4.5 Operation of Recorder with Display and Keypad

4.5.1 Monitoring Your Recorder

4.5.1.1 Overview

Introduction

In addition to the historical chart record, you can monitor the recorder's indicators and displays to see real time values of inputs. If control is enabled, then setpoint, output, and deviation values can also be displayed.

Set up values can also be viewed. Depending on the lockout status, configuration values may also be changed.

As a background task the recorder runs self-diagnostics on the printed circuit assemblies for the pens as described in *Section 8 – Troubleshooting and Pen Alignment of Recorder with Display*. If a test is failed, an error message will be displayed as described in Subsection 0. Depending on the recorder's configuration, a "failsafe" output value may be used for control in case of malfunction, as described in Section 8.

4.5.1.2 Operator interface

Display

The indicators and displays on the operator interface let you see what is happening to your process and how the recorder is responding. Figure 4-7 is a view of the operator interface. A description of the displays and indicators is included.

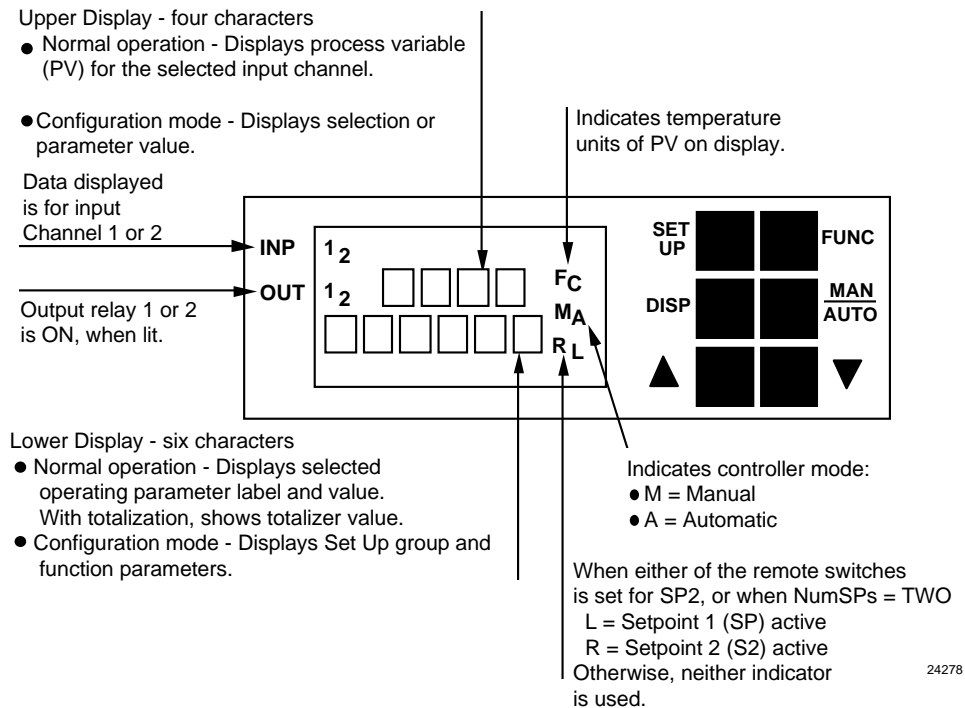

Figure 4-7 Operator Interface

Meaning of indicators

During normal operation, the indicators will light for the reasons shown in Table 4-26.

Table 4-26 Meaning of Indicators

Indicator	Definition when lit
INP 1 2	Data displayed is for channel 1 or 2
OUT 1 2	Output relay 1 or 2 is ON
A or M	Indicates the mode of operation: A = Automatic M = Manual
F or C	Indicates the temperature units of PV: F = Fahrenheit C = Celsius
R or L	L = Setpoint 1 (SP) active; R = Setpoint 2 (S2) active
KEYERR (in lower display)	Keystroke is invalid.



4.5.1.3 Viewing the operating parameters

Contents of display

The upper display uses four characters to display the value of the input. During normal operation, you can view various real time values and setpoints in the lower six-character display if the recorder supports control. Each value will be labeled. Press the **DISP** key to scroll through the displayed values listed in Table 4-27. If the recorder does not support control, then only the label “INP” or the totalizer value will appear in the lower display. (The input value will be in the upper display.)

The display shows only those parameters and values that apply to your specific model and the way in which it was configured. For recorders with two pens, remember that any controller-related values displayed correspond with the lighted INP indicator. “1” means that the values apply to the pen 1 input channel and “2” means that the values apply to the pen 2 input channel. Press **FUNC** key to toggle between input 1 and input 2.

Table 4-27 Lower Display Operating Parameter Labels

Label	Description
INP	Process variable value of currently selected input; if the recorder does not support options, then this label is always displayed. In this case the other parameters listed below are not applicable.
OT *	Controller output in percent for selected channel's control loop
SP *	Setpoint for selected channel
S2 *	Second setpoint for selected channel; this setpoint is used only if control group NumSPs = TWO, or if recorder supports digital inputs, and is configured to use this alternate setpoint in case an external event triggers the “remote switch”.
UseSPn *	If a second setpoint is available (because control set up group NumSPs = TWO), use this to select Setpoint 1 or Setpoint 2.
DE	Process variable deviation from setpoint currently being used.
[nnnnnn]	If totalizer is being used, the totalized value will be in the lower display (no label). To see the scale factor applicable to this value, see the totalizer set up group.
 □.□□ *	If the optional timer is active, either the time remaining on the timer (Hrs:Min), or elapsed time (Hrs:Min) will be displayed. If the “clock hand” is not moving, the timer is not running.
 □.□□ *	
SPRG n *	Select which setpoint program to run; n = 1 to 4.
RUN or HOLD *	If the optional Setpoint Program feature is currently executing a program, the status “RUN” or “HOLD” will also be displayed as part of the display cycle. See <i>Appendix C</i> for detailed instructions for executing a Setpoint Program.
N nn.nn	Currently executing setpoint program segment (N) and time remaining for segment (nn.nn) in hours and minutes.
REC nn	Setpoint program cycles remaining. Displayed only if the program was set to run more than one cycle, and if the program is not executing the last of multiple cycles.
TuneON or TuneOF *	Status of Accutune II. Displayed only if Accutune is enabled. See <i>Appendix D</i> for detailed Accutune instructions.

*You can press σ or τ to change the value or initiate some action when this parameter is displayed.

Diagnostic Error Messages

Recorders with displays run background tests as described in *Section 8 – Troubleshooting and Pen Alignment of Recorders with Display* to verify data and memory integrity. If there is a malfunction, an error message will blink in the lower display. If more than one self-diagnostic test fails, the display will cycle through the appropriate error messages.

A list of background test error messages is in Table 4-28.

If any of these error messages are displayed, refer to Section 8 for information on correcting the problem.

In addition, an error message will be displayed if the operator tries to run a setpoint program in which the number of the ending segment is lower than the segment number of the start segment. See *Appendix C* for details.

Table 4-28 Error Messages

Prompt	Description
CALERR	Indicates failure of the calibration test.
CFGERR	Indicates failure of the configuration test.
EEFAIL	Unable to write to nonvolatile memory
FAILSF	Failsafe value being used as output
INP FL	Two consecutive failures of input integration
INPRNG	Input out-of-range
P1 ERR or P2 ERR	Indicates error on channel other than the one on display.
RAMTST	Indicates failure of the RAM test.
SEGERR	Indicates that the number of the setpoint program's end segment is lower than the segment number of the start segment.

ATTENTION

In addition to error messages, the recorder will display special status messages when optional features are active.

- If the lower display flashes “TUNING”, the recorder is in the process of automatically determining tuning parameters using the Accutune II feature described in Appendix D.
- If the lower display flashes “RUN n” or “HOLD”, the recorder is executing setpoint program “n” as described in Appendix C, and the run or hold action was initiated locally.
- If the lower display flashes “run n” or “hold”, the recorder is executing setpoint program “n”, and the run or hold action was initiated remotely.

4.5.2 Operator Functions

4.5.2.1 Overview

Actions an operator can initiate

An operator can do the following:

- change the control mode (AUTO/MANUAL) and adjust the output manually (see Subsection 4.5.2.2)
- change the setpoint (see Subsection 4.5.2.3)
- check the alarm setpoints; the operator may also be able to change the setpoints, depending on the configured value of the “LOCK” parameter (see Subsection 4.5.2.4)
- run a key test (see Subsection 4.4.4.4)
- restore factory or field calibration values (see Subsection 4.5.2.5)
- *if the recorder has the totalizer option*, reset the totalizer to zero (see Subsection 4.5.2.6)
- *if the recorder has the timer option*, start the timer (see Subsection 4.5.2.7)
- *if the recorder is a limit controller*, reset the recorder to take it out of the limit state (see Subsection 4.5.2.8)
- *if the recorder supports Setpoint Programming*, run a program (*see Appendix C*)
- *if the recorder supports Accutune II*, use this automatic tuning feature (*see Appendix D*)

Note that being able to perform some actions depends upon how the recorder was configured and the features supplied on the recorder model. For example, control mode and setpoint only apply to units having optional output relays that have been configured for use in control.

INP (Input) indicator

Remember that any value displayed for a 2-pen recorder will be identified by the “1” or “2” at the left of the display, indicating the pen channel to which the value applies.

Press the FUNC key to toggle between pen channels.

4.5.2.2 Changing Control Mode and Adjusting Output Manually

Available modes

The recorder can operate in one of two modes.

- *Manual:* When switched to manual mode, the recorder holds its output at the last value used during automatic operation and stops adjusting the output for changes in process variable. In manual, the operator uses the keypad to adjust the output by changing the value shown in the upper display.







If the switch to manual is the result of an input failure sending the channel to failsafe operation, the output value displayed when the controller first switches to manual will be the value of the “FAILSF” parameter in the control set up group. This “FAILSF” value is expressed as a percentage. The output can be any value between 0 % and 100 %.

- *Automatic with Local Setpoint:* In automatic local mode, the recorder uses the local setpoint and automatically adjusts the output to maintain the setpoint at the desired value. In this mode you can adjust the setpoint as described in Subsection 4.5.2.3.

Procedure for selecting manual or automatic mode

Table 4-29 includes procedures for selecting automatic or manual mode, and for changing the output while in manual.

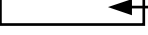
Table 4-29 Procedure for Selecting Automatic or Manual Mode







Step	Operation	Press	Action/Result
1	Selecting automatic mode		Until “A” indicator is ON. The recorder regulates its output to maintain the PV at the desired setpoint.
2	Selecting manual mode		Until “M” indicator is ON. The recorder holds its output at the last value used during automatic operation and stops adjusting the output for changes in setpoint or process variable. • If you get a “KEYERR” prompt, be sure control has been enabled through configuration as described earlier in this section.
3	Adjust the output in manual mode	 or 	Adjust the output value while in manual mode. Upper Display  shows the input value. Lower Display  shows OT and the output value in % for the selected channel.
4	Return to automatic mode		“A” indicator appears indicating automatic mode.

4.5.2.3 Changing the Control Setpoint

Procedure

The recorder can be set up for control on pen channel 1 and/or 2 as described earlier in this section. Follow the procedure in Table 4-30 to change the control setpoints.

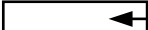
Table 4-30 Procedure for Changing the Control Setpoints

Step	Operation	Press	Action/Result
1	Select setpoint for the pen 1 channel (input 1).		until you see: Upper Display  shows the input value. Lower Display  shows SP and the setpoint value for the selected channel.
		▲ or ▼	to change the setpoint to the desired value.
2	Select setpoint for pen 2 (input 2)		Until "INP 2" indicator lights.
			until you see: Upper Display  shows the input value. Lower Display  shows S2 and the second setpoint for the selected channel.
		▲ or ▼	to change the setpoint to the desired value.
3	Return to input 1 parameters for display		to light "INP 1" indicator

If remote switch is set to SP2 then DISP will allow setting of second setpoint (S2).

4.5.2.4 Viewing and Changing Alarm Setpoints

Introduction







If the recorder hardware supports outputs, one or both relays can be used for alarming. An alarm is an indication that an event specified during configuration (process variable, for example) has exceeded one or more alarm limits. There are two alarms available for each pen (assuming no relay is being used for control). Each alarm has two setpoints. There are two alarm output selections, high and low. During configuration, each alarm setpoint is configured to alarm either high or low.

The alarm setpoints can be changed by the operator if the alarm parameters are not locked (see Subsection 4.3.19). **If a recorder output is being used for control, that output is not available as an alarm and the prompts will not appear.**

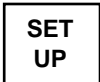
Procedure

The procedure for displaying and changing the alarm setpoints is listed in Table 4-31.

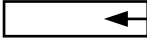
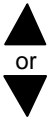
Table 4-31 Procedure for Displaying or Changing the Alarm Setpoints

Step	Operation	Press	Action/Result
1	Access the Alarm Set Up group		Until you see: Upper Display  Lower Display 
2	Access the Alarm Setpoint Values		Until you display the desired alarm setpoint and its value. Their order of appearance is shown below. Upper Display  ← The alarm setpoint value Lower Display  A1S1 VA = (Alarm 1, Setpoint 1 value) A1S2 VA = (Alarm 1, Setpoint 2 value) A2S1 VA = (Alarm 2, Setpoint 1 value) A2S2 VA = (Alarm 2, Setpoint 2 value)
			Change any alarm setpoint value you select in the upper display.
3	Return to normal operation		Returns to normal operation.

4.5.2.5 Selecting Factory or Field Calibration Values

Introduction

Recorders are calibrated at the factory. The calibration values for each pen channel are stored on the printed circuit assembly associated with the pen. In addition, provision is made for the storage of field calibration values. The procedure for calibrating an input is provided in *Section 5 – Input and Output Calibration for Recorder with Display*. Entering field calibration values does not affect the stored factory calibration.

The “LD CAL” parameter in the input set up group for each pen channel permits you to specify whether factory or field calibration values are to be used by the recorder.





Procedure

Follow the procedure in Table 4-32 to select factory or field calibration values.

ATTENTION

If you change the type of input used by the recorder, you must change the setting of the “IN TYP” parameter in the input set up group (see Subsection 4.3.7). Changing the input type also requires changing the settings of hardware switches at SW6 (see Subsection 4.3.5.2).

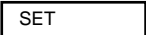
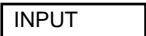
Table 4-32 Procedure for Selecting Factory or Field Calibration Values

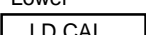
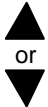
Step	Press	Action
1		Select the desired input (indicator INP 1 or INP 2).
2		Until you see: Upper Display  Lower Display 
3		Until you see: Upper  ← Present value Lower  (FAC or FLD)
4	 or 	Select FAC (factory) or FLD (field). ATTENTION Until field calibration has been done, FLD uses the same calibration values as FAC. When field calibration is performed, the value of LD CAL is automatically set to FLD at the completion of the field calibration operation.
5		Be sure the correct sensor is connected to the input terminals and resume normal operation.

4.5.2.6 Resetting the Totalizer

Introduction

The models having a display and keypad are available with an optional totalizer to calculate and display the total flow volume as measured by the pen channel's input. The displayed value is six digits with a configurable scale factor. The scale factor is displayed as "En", where n is 10^n . For example:







- If the display reads "189 E0", then the totalized value since last reset is 189×10^0 or 189.
- If the display reads "189 E3", then the totalized value since last reset is 189×10^3 or 189,000.
- If the display reads "189" E8", then the totalized value since the last reset is 189×10^8 or 18,900,000,000.

The value of the totalizer set up group parameter "RSTABL" (resettable) determines whether and how the totalizer can be reset. If RSTABL = KEY, then the totalizer can be reset using the procedure in Table 4-33. If RSTABL is set to REM1 or REM2, the totalizer will be reset by Digital Input 1 or Digital Input 2, respectively.

Reset procedure

Follow the procedure in Table 4-33 to reset the totalizer (return value to 0).

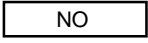
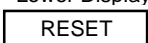
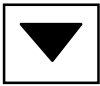
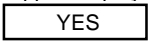
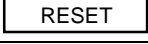
Table 4-33 Procedure for Resetting Totalizer

Step	Press	Action/Result
1		Select channel.
2	 until you see	Upper Display  Lower Display  If "TOTAL" doesn't appear or prompt access is declined, check "LOCK" configuration.
3		You will see: Upper Display  Lower Display 
4		You will see: Upper Display  Lower Display 
5		The totalizer will reset to zero.
6		The recorder will return to the same state it was in before configuration (set up) mode was entered. The value of the RESET parameter will automatically be returned to NO after the reset operation.

4.5.2.7 Starting the Timer

Introduction

The DR4300 is available with an optional timer. This timer can be configured to be started by Alarm 1 or the keypad. (If the recorder supports digital inputs, one can be used to trigger the timer. This remote switch is independent of whether the timer is configured to start with the alarm or the keypad.)

Once the timer has been started, it cannot be stopped with the Increment and Decrement keys (see Step 3 below).





At the end of timer period Relay 2 will be energized, and remain energized until the timer is reset.

- If the timer set up group parameter $START = KEY$, then restarting the timer will involve pushing the Increment or Decrement key twice while the timer is displayed: once to reset the timer and de-energize Relay 2, and the second to start the timer.
- If the timer set up group $START = AL1$, then when Alarm 1 toggles (goes inactive, then active again) the timer is reset and restarted. When the timer is configured to start via Alarm 1, the timer can be reset (but not restarted) with the Increment or Decrement key. If the Alarm 1 relay is still energized when you reset the timer with the key, then the timer will be restarted immediately.

Procedure

Use the procedure in Table 4-34 to start the timer.

Table 4-34 Procedure for Starting Timer

Step	Press	Action/Result
1	 until you see	 n.nn where n.nn is: <ul style="list-style-type: none"> • 0.00 if the timer is configured to show elapsed time, or • the hours and minutes set on the timer if it is configured to show time remaining.
2	 or 	You will see the “clock hand” start to move: <ul style="list-style-type: none"> • counterclockwise if the timer is configured to show elapsed time, or • clockwise if the timer is configured to show time remaining. After a minute, the time indication will change.
3		The timer cannot be stopped with the Increment or Decrement key. To stop the timer go into the timer set up group and disable the timer.

4.5.2.8 Resetting the Limit Controller

Introduction

The DR4300 is available as a limit controller. On each pen channel's printed circuit assembly Relay 1 is used for limit control. When the recorder detects that the input has exceeded the limit (or fallen below the limit, depending on how the unit is configured) the controller goes to the limit state: Relay 1 is **de-energized**.

Limit controller operator interface

The operator interface on a limit controller is the same as that of other models having a display and keypad. The MAN/AUTO/RESET key functions as a reset only. Manual and Auto mode do not apply to the limit controller.



When the recorder's controller goes to the limit state (relay de-energized), the operator will be alerted to the limit state by a message on the bottom line of the display.

- If the input that triggered the limit state is on the pen channel being displayed, the message will be "LIMIT".
- If the input that triggered the limit state is on the other pen channel, the message will be "Pn ERR" (where n is the limit state's pen channel). Pressing the "FUNC" key to switch channels will display the "LIMIT" message.

Reset procedure

Follow the procedure in Table 4-35 to reset the limit controller (take it out of the limit state).

Table 4-35 Procedure for Resetting Limit Controller

Step	Press	Action
1		Correct the cause of the limit state.
2		Select the desired input (indicator INP 1 or INP 2).
3		Press the RESET key.* The limit controller will resume normal operation, monitoring the value of the input and comparing it to the configured limit value.

* This refers to the MAN/AUTO/RESET key on the keypad, **NOT** the reset switch SW2 on the printed circuit assembly for the pen channel.

The Limit Controller may also be reset remotely; see XRSET function in Subsection 4.3.22.

Output LED is on when relay is energized (not in limit).

5. Input and Output Calibration for Recorder with Display

5.1 Overview

Introduction

This section explains how to field calibrate analog inputs, as well as a 4 to 20 mA current output for a model having a display and keypad.

Because the recorder stores both factory and field calibration values for inputs in memory, you can easily select either factory or field calibration values for use by the recorder using the procedure given in Subsection 4.5.2.5.

To calibrate an input:

- Determine the minimum and maximum range values to be used for calibration (see Subsection 5.2).
- Prepare to calibrate (see Subsection 5.3).
- Set up and wire the input for calibration (see Subsection 5.4).
- Use the parameters in the calibration set up group to store field calibration values in the recorder's memory (see Subsection 5.5).

What's in this section?

The following is a list of the topics covered in this section.

Topic	See Page
5.1 Overview	141
5.2 Input Calibration Minimum and Maximum Range Values	142
5.3 Input Calibration Preliminary Information	144
5.4 Input Calibration Set Up and Wiring	146
5.5 Input Calibration Procedure	151
5.6 Current Output Calibration	153



WARNING—SHOCK HAZARD



INPUT CALIBRATION MAY REQUIRE ACCESS TO HAZARDOUS LIVE CIRCUITS, AND SHOULD ONLY BE PERFORMED BY QUALIFIED SERVICE PERSONNEL. MORE THAN ONE SWITCH MAY BE REQUIRED TO DE-ENERGIZE UNIT BEFORE CALIBRATION.

5.2 Input Calibration Minimum and Maximum Range Values

Minimum and maximum range values

You should calibrate the recorder for the minimum (0 %) and maximum (100 %) range values of your particular sensor. If your recorder has two (pens) inputs, calibrate each input separately.

Make sure the correct input is on display INP1 or INP2; use the FUNC key to select the input.

Select the voltage or resistance equivalent for 0 % and 100 % range values from Table 5-1. Use these values when calibrating your recorder.

Table 5-1 Voltage and Resistance Equivalents for 0 % and 100 % Range Values

Sensor Type	PV Input Range		Range Values*		
	°F	°C	0 %	68 °F/20 °C	100 %
Thermocouples					
B	105 to 3300	41 to 1816	0 mV		13.769 mV
E	-454 to 1832	-270 to 1000	-9.835 mV	1.192 mV	76.373 mV
E (low)	-200 to 1100	-129 to 593	-6.472 mV		44.555 mV
J	0 to 1600	-18 to 871	-0.886 mV	1.019 mV	50.060 mV
J (low)	20 to 770	-7 to 410	-0.334 mV		22.400 mV
K	-320 to 2500	-196 to 1371	-5.822 mV	0.798 mV	54.856 mV
K (low)	-20 to 1000	-29 to 538	-1.114 mV		22.255 mV
Ni-Ni-Moly	32 to 2500	0 to 1371	-0.000 mV	0.755 mV	71.773 mV
Nicrosil-Nisil	0 to 2372	-17.8 to 1300	-0.461 mV	0.525 mV	47.513 mV
R	0 to 3100	-18 to 1704	-0.090 mV	0.111 mV	20.281 mV
S	0 to 3100	-18 to 1704	-0.092 mV	0.113 mV	17.998 mV
T	-420 to 700	-251 to 371	-6.187 mV	0.789 mV	19.097 mV
T (low)	-200 to 600	-129 to 316	-4.149 mV		15.771 mV
W5W26	0 to 4200	-18 to 2315	-0.234 mV	0.273 mV	37.075 mV
RTD					
100 Ω **	-300 to 900	-184 to 482	25.18 Ω		274.96 Ω
100 Ω (low)**	-130 to 392	-90 to 200	64.30 Ω		175.84 Ω
100 Ω (T)***	-238 to 482	-150 to 250	38.79 Ω		195.57 Ω
Milliamps	0 mA to 20 mA		0 mA		20 mA
	4 mA to 20 mA		4 mA		20 mA
Millivolts	0 mV to 10 mV		0 mV		10 mV
	0 mV to 100 mV		0 mV		100 mV
	0 mV to 200 mV		0 mV		200 mV
Volts	0 V to 1 V		0 V		1 V
	0 V to 2 V		0 V		2 V
	1 V to 5 V		1 V		5 V
	0 V to 5 V		0 V		5 V
	0 V to 10 V		0 V		10 V
	2 V to 10 V		2 V		10 V

*Range values for thermocouples are based on a cold junction temperature of 32 °F (0 °C). These values must be adjusted for the actual cold junction temperature when using the ambient temperature method for calibrating thermocouple inputs.

** IEC Alpha = 0.00385

*** Alpha = 0.00391

5.3 Input Calibration Preliminary Information

Equipment needed

Table 5-2 lists the equipment required to calibrate various types of inputs. You will also need a medium size bladed screwdriver for general use and a small bladed screwdriver for use with the screws on the connector plugs.

Table 5-2 Equipment Needed for Calibration

Type of Input	Equipment Needed
Thermocouple Inputs (Compensated Calibrator)	<ul style="list-style-type: none"> • A compensated calibrator with ± 0.02 % accuracy. • Thermocouple extension wire that corresponds with the type of thermocouple that will be used with the recorder input.
Thermocouple Inputs (Ice Bath)	<ul style="list-style-type: none"> • A calibrating device with ± 0.02 % accuracy for use as a signal source such as a millivolt source. • Thermocouple extension wire that corresponds with the type of thermocouple that will be used with the recorder input. • Two insulated copper leads for connecting the thermocouple extension wire from the ice baths to the precision calibrator. • Two containers of crushed ice, or an ice point reference.
RTD (Resistance Temperature Detector)	<ul style="list-style-type: none"> • A resistance decade box, with ± 0.02 % accuracy, capable of providing stepped resistance values over a minimum range of 0 ohms to 1400 ohms with a resolution of 0.01 ohm. • Three insulated copper leads for connecting the decade box to the recorder.
Milliamp, Millivolt, and Volts Inputs	<ul style="list-style-type: none"> • A calibrating device with ± 0.02 % accuracy for use as a signal source. • Two insulated copper leads for connecting the calibrator to the recorder.

Disconnect the field wiring

Depending on which input (1 or 2) you plan to calibrate, tag and disconnect any field wiring connected to the input terminals on the printed circuit assembly for the appropriate pen channel. Refer to Figure 5-1 and follow the procedure in Table 5-3.

Table 5-3 Disconnect the Field Wiring

Step	Action
1	Remove the power from the recorder, open the door on the recorder, and swing the chart plate out.
2	Depending on the input (1 or 2) you are going to calibrate, disconnect the input connections from terminal block TB2 on the right edge of the applicable printed circuit assembly. See Figure 5-1 for the location of the circuit boards and input connectors.

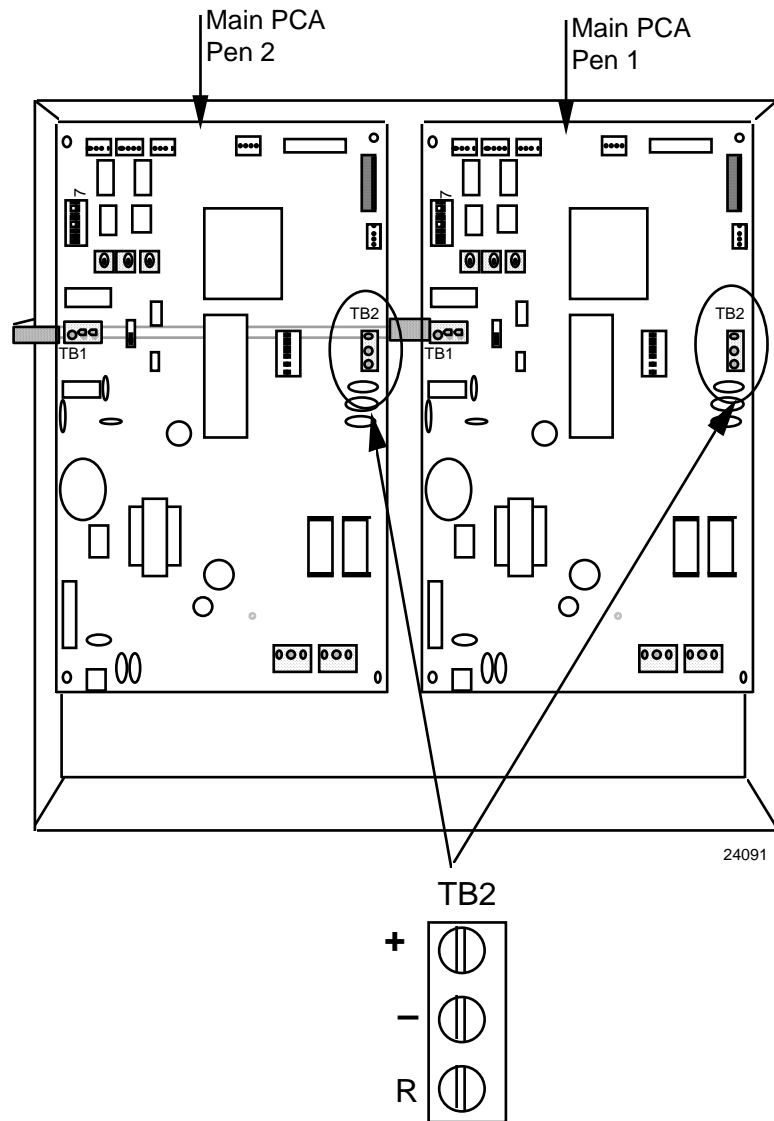

Figure 5-1 Location of the Input Connections on the Input Boards

5.4 Input Calibration Set Up and Wiring

5.4.1 General Calibration Set Up

DIP switch settings

Before starting the calibration activity, check that the input switches SW6 on the applicable printed circuit assembly (pen 1 or pen 2) are set correctly for the type of sensor being calibrated. (See *Section 4 – Configuration, Startup, and Operation of Recorder With Display.*)

General set up procedure

Table 5-4 lists the general set up procedure for all methods of calibration. Do this procedure and then refer to the set up procedure and diagram specific to your input type.

Table 5-4 General Calibration Set Up Procedure

Step	Action
1	Set up and connect the calibrator to the input terminals for the applicable printed circuit assembly in your recorder according to the type of input sensor being used. Refer to the following figures for corresponding set-up diagrams: <ul style="list-style-type: none"> • Figure 5-2 Calibration Set Up Diagram for Thermocouple Inputs Using a Compensated Calibrator • Figure 5-3 Calibration Set Up Diagram for Thermocouple Inputs Using an Ice Bath • Figure 5-4 Calibration Set Up Diagram for RTD Inputs • Figure 5-5 Calibration Set Up Diagram for Millivolts, Volts, and Milliamps Inputs.
2	Route leads (for example: copper leads or thermocouple extension wires) through a conduit hole in the recorder case so that you will be able to close the chart plate.
3	Close the chart plate after you have completed the applicable calibration set up.

5.4.2 Thermocouple Inputs Using a Compensated Calibrator

Refer to Figure 5-2 and wire the recorder according to the procedure given in Table 5-5.

Table 5-5 Set Up Wiring Procedure for Thermocouple Inputs Using a Compensated Calibrator

Step	Action
1	Connect the thermocouple extension wire to the calibration source (see Figure 5-2).
2	Connect the other end of the thermocouple extension wires to the TB2 terminals on the printed circuit assembly for the input channel being calibrated.

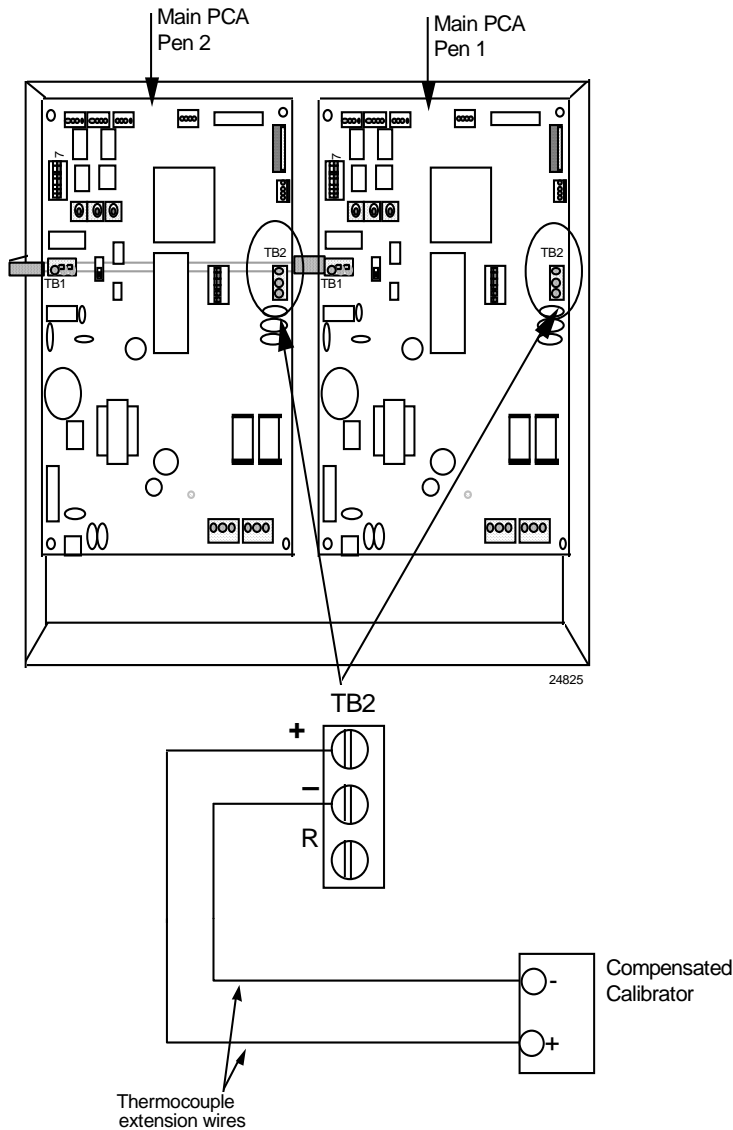

Figure 5-2 Calibration Set Up Diagram for Thermocouple Inputs Using a Compensated Calibrator

5.4.3 Thermocouple Inputs Using an Ice Bath or Ice Point Reference

Refer to Figure 5-3 and wire the recorder according to the procedure given in Table 5-6.

Table 5-6 Set Up Wiring Procedure for Thermocouple Inputs Using an Ice Bath

Step	Action
1	Connect the copper leads to the calibration source (see Figure 5-3).
2	Connect a length of thermocouple extension wire to the end of each copper lead and insert the junction points into the ice bath.
3	Connect the other end of the thermocouple extension wires to the TB2 terminals on the printed circuit assembly for the input channel being calibrated.

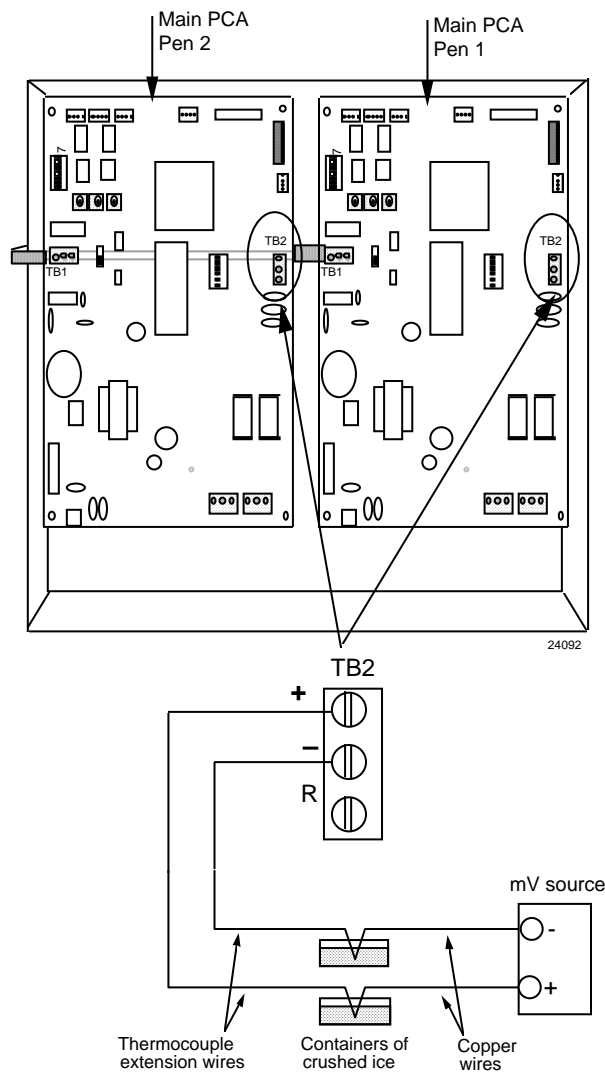

Figure 5-3 Calibration Set Up Diagram for Thermocouple Inputs Using an Ice Bath

5.4.4 RTD (Resistance Temperature Detector) Inputs

Refer to Figure 5-4 and wire the recorder according to the procedure given in Table 5-7.

Table 5-7 Set Up Wiring Procedure for Calibrating RTD Inputs

Step	Action
1	Connect the copper wire to the calibration source (see Table 5-3).
2	Connect the other end of the copper wire to the TB2 terminals on the printed circuit assembly for the input channel being calibrated.

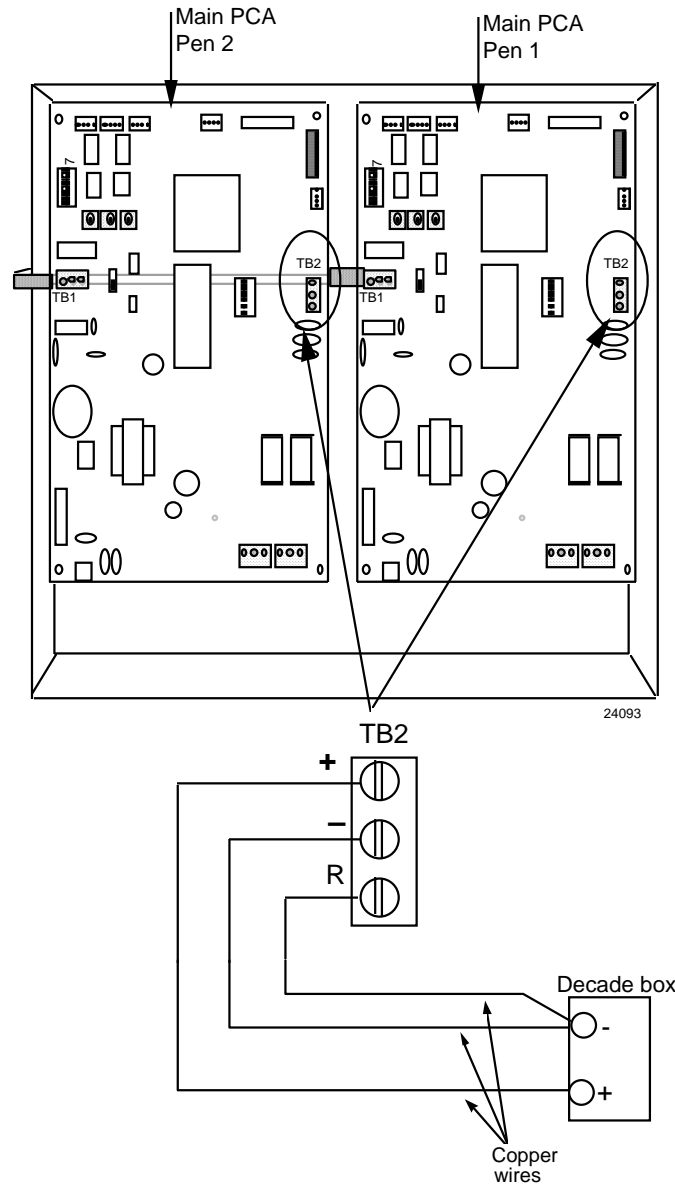

Figure 5-4 Calibration Set Up Diagram for RTD Inputs

Millivolts, Volts and Milliamps inputs

Refer to Figure 5-5 and wire the recorder according to the procedure given in Table 5-8.

Table 5-8 Set Up Wiring Procedure for Calibrating Millivolts, Volts, and Milliamps Inputs

Step	Action
1	Connect the copper wire to the calibration source (see Figure 5-5).
2	Connect the other end of the copper wire to the TB2 terminals on the printed circuit assembly for the input channel being calibrated.

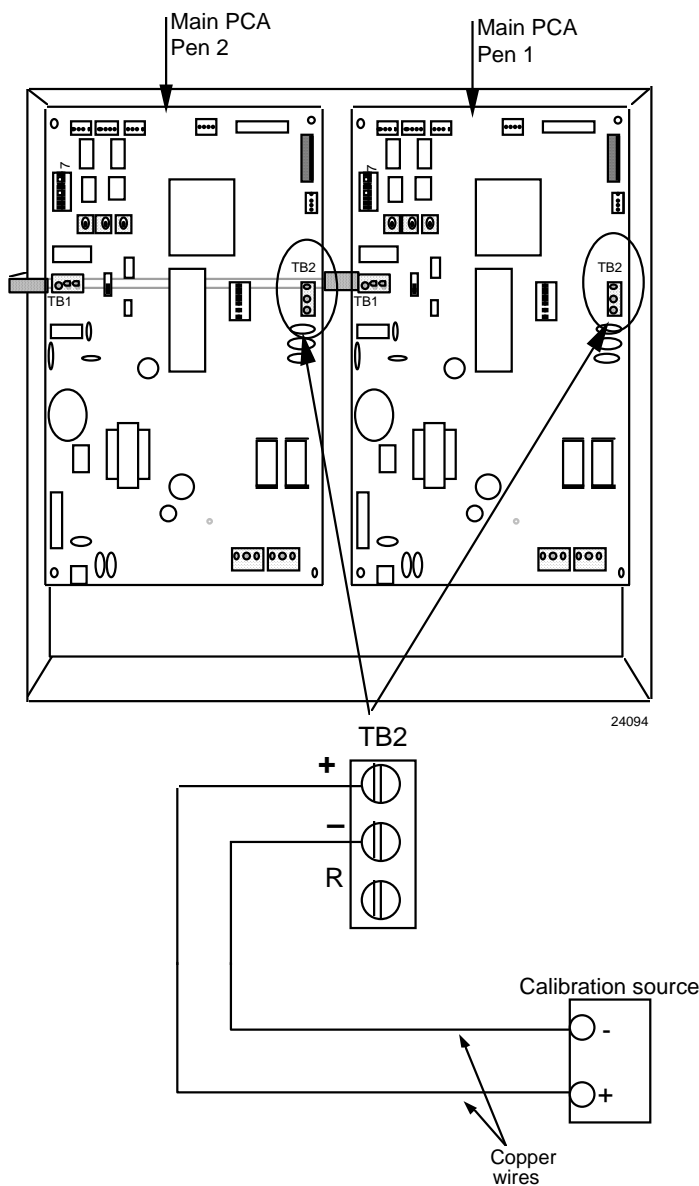

Figure 5-5 Calibration Set Up Diagram for Millivolts, Volts, and Milliamps Inputs

5.5 Input Calibration Procedure

Introduction

Before performing this procedure, be sure the recorder is wired for calibration as described in Subsection 5.4. Apply power and allow the recorder to warm up for 30 minutes before you calibrate.

Make sure “LOCK” is set to “NONE” (see *Section 4 - Configuration, Startup and Operation of Recorder with Display*).

ATTENTION

For Milliamp inputs, be sure the current source is at zero before switching on the calibrator. Do not switch the calibrator on/off while it is connected to the recorder’s input. Failure to observe this precaution could result in damage to input circuits.

Calibration procedure sequence

The calibration procedure sequence for all inputs is listed in Table 5-9. The calibration procedure for inputs 1 and 2 is identical. The displays indicate the input number.









Press the  key to change display as required (INP1 or INP2).

Table 5-9 Input Calibration Procedure Sequence

Step	Description	Press	Action/Result
1	Enter Calibration Mode	 until you see	Upper Display  Lower Display  If “CAL” doesn’t appear or prompt access is declined, check “LOCK” configuration.
			You will see: Upper Display  Lower Display 
			The calibration sequence is enabled and you will see: Upper Display  Lower Display 

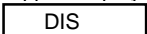
Step	Description	Press	Action/Result
2	Calibrate 0 %	<div style="border: 1px solid black; padding: 5px; width: fit-content; margin: 0 auto;">FUNC</div>	<p>You will see:</p> <p>Upper Display</p> <div style="border: 1px solid black; padding: 2px; width: fit-content; margin: 0 auto;">APLY</div> <p>Lower Display</p> <div style="border: 1px solid black; padding: 2px; width: fit-content; margin: 0 auto;">INZERO</div> <ul style="list-style-type: none"> • Adjust your calibration device to an output signal equal to the 0 % range value for your particular input type. See Table 5-1 for Voltage or Resistance equivalents. • Wait 60 seconds, then go to the next step.
3	Calibrate 100 %	<div style="border: 1px solid black; padding: 5px; width: fit-content; margin: 0 auto;">FUNC</div>	<p>You will see:</p> <p>Upper Display</p> <div style="border: 1px solid black; padding: 2px; width: fit-content; margin: 0 auto;">APLY</div> <p>Lower Display</p> <div style="border: 1px solid black; padding: 2px; width: fit-content; margin: 0 auto;">INSPAN</div> <p>Adjust your calibration device to an output signal equal to the 100 % range value for your particular input type (see Table 5-1 for voltage or resistance equivalents). Wait 60 seconds, then go to next step.</p>
4	Exit the Calibration Mode	<div style="border: 1px solid black; padding: 5px; width: fit-content; margin: 0 auto;">FUNC</div>	<p>The recorder stores the calibration constants.</p> <p>The value of input set up group parameter "LD CAL" is set to "FLD" (field).</p> <p>The recorder begins to use the new field calibration values for this channel.</p> <p><i>Repeat this procedure for the other pen, if required.</i></p>

5.6 Current Output Calibration

Introduction

Calibrate the recorder so that the output provides the required amount of current over the desired range. The recorder can provide an output current range of from 0 to 20 milliamperes and can be calibrated at 4 mA for 0 % of output and 20 mA for 100 % of output, or at any other values between 0 mA and 20 mA.

Equipment needed

You will need a standard shop type milliammeter, with whatever accuracy is required, capable of measuring 0 milliamps to 20 milliamps.

Calibrator connections

Refer to Figure 5-6 and wire the recorder according to the procedure given in Table 5-10.

Table 5-10 Set Up Wiring Procedure for Current Proportional Output

Step	Action
1	With the power off, door open, and the chart plate swung out; tag and disconnect field wiring from the terminals on terminal block TB5 on the printed circuit assembly for pen 1 or pen 2 as applicable (see Figure 5-6).
2	Observing polarity, connect a milliammeter's leads to TB5 terminals.
3	Close the chart plate: apply power and allow the recorder to warm up 15 minutes before you calibrate.

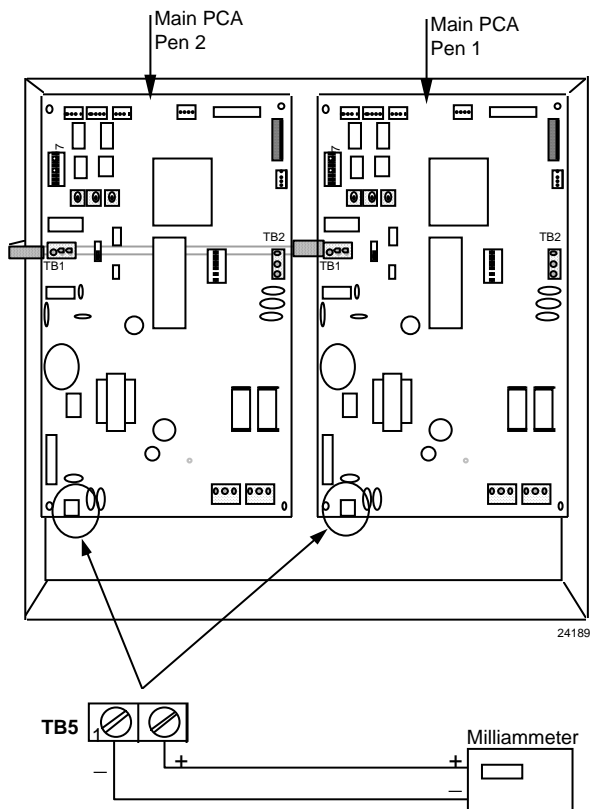

Figure 5-6 Test Equipment Connections for Calibrating Current Output











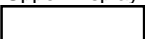

Procedure

The procedure for calibrating the current proportional output is listed in Table 5-11. Make sure “LOCK” in the Set Up group is set to “NONE.”

For display recorders with 2 pens, be sure the correct input is on display—INP 1 or INP 2 indicator is lit.

Press **FUNC** key to change input on display to agree with the control loop output to be calibrated.

Table 5-11 Procedure for Calibrating Current Output

Step	Description	Press	Action/Result
1	Enter Calibration Mode	 until you see	Upper Display  Lower Display  If “CAL” doesn’t appear or prompt access is denied, check the “LOCK” configuration.
2	Calibrate 0 %		You will see: Upper Display  a value (approximately 365) Lower Display 
		 or 	Until the desired 0 % output is read on the milliammeter. Use the values shown below depending on the action of your recorder.
3	Calibrate 100 %		Stores the 0 % value and, you will see: Upper Display  a value (approximately 1800) Lower Display 
		 or 	Until the desired 100 % output is read on the milliammeter. Use the values shown below depending on the action of your recorder.

Step	Description	Press	Action/Result
4	Exit Calibration Mode	<div style="border: 1px solid black; padding: 5px; display: inline-block;"> FUNC </div>	The recorder stores the span value. Repeat procedure for the other pen. Remove power from recorder and disconnect the milliammeter and connect output wiring.
		<div style="border: 1px solid black; padding: 5px; display: inline-block;"> DISP </div> or <div style="border: 1px solid black; padding: 5px; display: inline-block;"> SET UP </div>	To exit the calibration mode.

6. Routine Maintenance

6.1 Overview

Introduction

Unless the recorder's location will expose it to dust, the DR4300 recorder does not require any periodic maintenance except the replacement of the chart and ink cartridges.

This section provides instructions for replacing the chart and ink cartridge. It also contains tips for maximizing the life of the pens, including recommended practices if the recorder is used in a dusty area.

ATTENTION

Humidity can affect the size of the chart, resulting in the pen being offset from the proper chart increment. Instructions for aligning the pens are provided in *Section 7 – Troubleshooting and Pen Alignment for Recorder Without Display* and *Section 8 – Troubleshooting and Pen Alignment for Recorder With Display*.

What's in this section?

The following is a list of the topics covered in this section.

Topic	See Page
6.1 Overview	157
6.2 Replacing the Chart	158
6.3 Replacing the Ink Cartridge	159
6.4 Maximizing Pen Life	160

6.2 Replacing the Chart

Procedure

Refer to Figure 6-1 and follow the procedure in Table 6-1 to replace the chart.

Table 6-1 Procedure for Replacing the Chart

Step	Action
1	Turn off the power to the recorder, then open the door.
2	Pull up on the pen lifter to raise the pen(s) from the chart plate.
3	Lift the chart from the hub, and slide it from under the pen(s) to remove it from the chart plate.
4	Slip the new chart under the pen lifter, pens and time index; and press the chart into place over the chart hub.
5	Turn the chart until the desired time line on the chart is aligned with the time index on the chart plate and pen 1 before closing the locking clip on the hub. Push down on the lifter to return the pen(s) to the chart. CAUTION: Do not try to rotate the hub
6	Close the door and apply power.

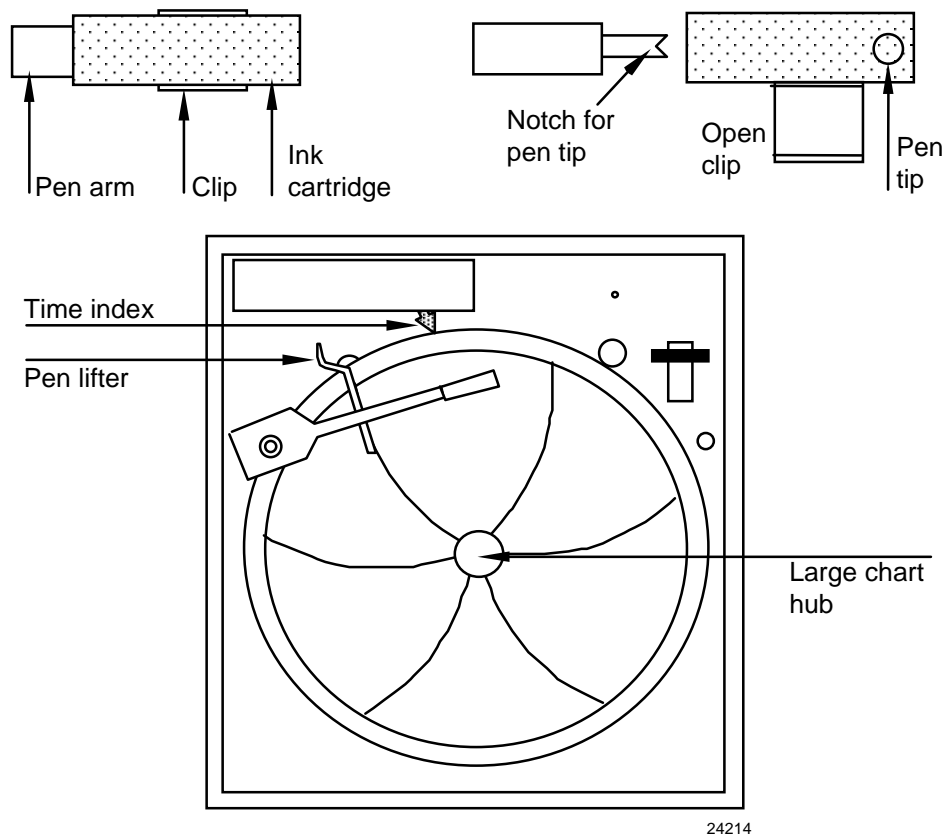

Figure 6-1 Replacing the Chart and Ink Cartridge

6.3 Replacing the Ink Cartridge

Procedure

Refer to Figure 6-1 and follow the procedure in Table 6-2 to replace the ink cartridge.

Table 6-2 Procedure for Replacing the Ink Cartridge

Step	Action
1	Remove the power from the recorder, then open the door.
2	Pull up on the pen lifter to raise the pen(s) from the chart plate.
ATTENTION Be careful not to move the pen arm while removing and installing the ink cartridge.	
3	Unclip and remove the purple (pen 1) or red (pen 2) ink cartridge from the pen arm.
4	Remove the protective cap from the pen tip on the new cartridge and open its clip. (If you plan to store or ship the recorder, save the protective cap.)
5	Slide the new cartridge onto the pen arm so that its tip fits into the notch at the end of the pen arm and close the clip to secure the cartridge to the pen arm.
6	Push down the pen lifter to return the pen tip to the chart.
7	Close the door and apply power.

6.4 Maximizing Pen Life

Steps for maximizing pen life

Table 6-3 lists steps that will help maximize the life of recorder pens.

Table 6-3 Maximizing Pen Life

Step	Action
1	Store the chart paper in a cool, clean dry place where the temperature does not exceed 40 °C (104 °F) and the humidity is below 65 % RH.
2	Do not expose the pen tip and chart paper to abrasive chemicals or dust that cause excessive pen wear.
3	If the recorder is used in a dusty atmosphere, provide a positive 'clean air purge' to minimize dust particle accumulation on the chart paper.
4	Periodically clean the pen arm using a cotton swab dipped in alcohol. This is more important when the recorder is located in a dusty environment and no 'clean air purge' is used.
5	Never let the pen tip ride on the chart plate when the paper is not present. Use the pen lifter to raise the arm when changing the paper.
6	Keep the door closed while recording.
7	Always cover the pen arm tip with its protective cap when storing or shipping the recorder.
8	Be sure that the chart paper lays flat against the chart plate. Any ripple in the paper will cause light pen printing.
9	Be sure the chart hub assembly is pushed onto the motor shaft so that it is flush with the chart plate.

7. Troubleshooting and Pen Alignment of Basic Recorder without Display

7.1 Overview

Introduction

This section explains how to use observable symptoms of failure to troubleshoot the recorder models that do not have a display.

- To reduce recorder down-time, this section enables tracing trouble to a printed circuit assembly (PCA)/hardware assembly level rather than to an individual component.
- While troubleshooting is straightforward, we recommend that only trained service technicians repair the recorder. **SEE THE SHOCK HAZARD WARNING BELOW.**

This section also includes instructions for aligning the pens.

What's in this section?

The following is a list of the topics covered in this section.

Topic	See Page
7.1 Overview	161
7.2 Observable Symptoms of Failure	163
7.3 Troubleshooting Procedures	164
7.4 Alignment of Pen at Zero and 100 %	169



WARNING—SHOCK HAZARD



TROUBLESHOOTING MAY REQUIRE ACCESS TO HAZARDOUS LIVE CIRCUITS, AND SHOULD ONLY BE PERFORMED BY QUALIFIED SERVICE PERSONNEL. MORE THAN ONE SWITCH MAY BE REQUIRED TO DE-ENERGIZE UNIT BEFORE SERVICING.

Types of problems

Instrument performance can be adversely affected by installation and application problems as well as by hardware problems. We recommend that you investigate the problems in the order listed below, and use the information in this section to solve them. If replacement of any part is required, follow the procedures in *Section 9 – Replacing Hardware Assemblies*.

- Installation related problems
- Application related problems
- Hardware and software related problems

Installation related problems

Read *Section 2 – Installation* to make sure the DR4300 has been properly installed. Document 51-52-05-01 *How to Apply Digital Instrumentation in Severe Electrical Noise Environments* can provide additional relevant information.

ATTENTION

System noise induced into the recorder may result in transient abnormalities in performance.

If system noise is suspected, completely isolate the recorder from all field wiring. Use calibration sources to simulate PV and check all recorder and control functions; that is, pen functions, chart trace, output, alarms, etc.

Application related problems

Review the application of the recorder; then, if necessary, direct your questions to the local sales office.

Hardware and software related problems

Observe the symptoms to identify typical failures which may occur in the recorder. Follow the troubleshooting procedures to correct the problems.

7.2 Observable Symptoms of Failure

Introduction

If erratic operation is observed, refer to the failure symptoms in Table 7-1, then follow the appropriate troubleshooting procedure in Subection 7.3.

Symptoms

Compare your recorder's symptoms with those shown in Table 7-1 and refer to the indicated subsection for the appropriate troubleshooting procedure.

Table 7-1 Observable Symptoms of Failure

Symptom	See Subsection
Recorder will not operate.	7.3.2
Recorder operation is normal but pen trace is incorrect.	7.3.3
Chart rotates at wrong speed or will not rotate (pen indication correct).	7.3.4
Pen remains at high end of range when input signal is low.	7.3.5

7.3 Troubleshooting Procedures

7.3.1 Overview

Introduction

The troubleshooting procedures for the observable symptoms of failure are presented in the same order as they appear in Table 7-1. Each procedure includes what to do if you have that particular problem, as well as instructions for accomplishing the task, or a cross-reference to instructions elsewhere in the manual.

Equipment needed

You will need a voltmeter to troubleshoot the symptoms listed in the tables that follow.

Safety precautions

Exercise appropriate safety precautions when troubleshooting the recorder operation.



WARNING—SHOCK HAZARD



TROUBLESHOOTING MAY REQUIRE ACCESS TO HAZARDOUS LIVE CIRCUITS, AND SHOULD ONLY BE PERFORMED BY QUALIFIED SERVICE PERSONNEL. MORE THAN ONE SWITCH MAY BE REQUIRED TO DE-ENERGIZE UNIT BEFORE SERVICING.

7.3.2 Recorder Failure Troubleshooting

Procedure

Table 7-2 explains how to troubleshoot recorder failure symptoms.

Table 7-2 Troubleshooting Recorder Failure Symptoms

Step	What to do	How to do it or where to find the instructions
1	Check the supply voltage.	Measure the line voltage across the line and neutral connections at TB1 on the printed circuit assembly (PCA) on the right (for pen 1).
2	Check the connections to TB1 on the pen 1 PCA.	Refer to ac wiring procedures in <i>Section 2 – Installation</i> .
3	Check the system for brown-outs, heavy load switching, etc.; and conformance to installation instructions.	Refer to <i>Section 2 – Installation</i> .
4	Replace the PCA for pen 1.	Refer to the replacement procedures in <i>Section 9 – Replacing Hardware Assemblies</i> .

7.3.3 Pen Trace Troubleshooting

Procedure

Table 7-3 explains how to troubleshoot a pen trace problem.

Table 7-3 Troubleshooting Pen Trace Failure Symptoms

Step	What to do	How to do it or where to find the instructions
1	Check the ink cartridge for proper installation.	Reposition or replace the ink cartridge as described in <i>Section 6 – Routine Maintenance</i> . If the pen arm is severely warped, replace the pen arm as described in <i>Section 9 – Replacing Hardware Assemblies</i> .
2	Check that the chart agrees with the actuation type and chart set up.	Replace wrong chart with correct chart. Refer to <i>Section 3 – Configuration, Startup, and Operation of Recorder without Display</i> for instructions for viewing the configuration. See <i>Section 6 – Routine Maintenance</i> for instructions for replacing the chart.
3	Check the pen alignment.	Follow the procedure in Subsection 7.4.
4	Look at printed circuit assembly (PCA) for the pen to see if the red* LED is lit. This LED is lit when the PCA failed a self-diagnostic, or an out-of-range input has been detected. (Flashing green LED is OK, it indicates that the processor is active.)	Press the reset switch SW2. The PCA will be initialized. If the problem was a software error, the error may be cleared by the reset. *For Recorders with a display, the red LED is used by an internal control signal and is not a fault indicator.
5	Check the sensor for the proper type and its ability to function.	Verify the input configuration data and operation of the sensor. Measure input signal at TB2 or apply calibration source to verify input signal.
6	Replace the servo plate assembly.	Refer to the replacement procedure in <i>Section 9 – Replacing Hardware Assemblies</i> .
7	Replace the printed circuit assembly for the pen with the problem.	Refer to the replacement procedure in <i>Section 9 – Replacing Hardware Assemblies</i> .

7.3.4 Chart Rotation Troubleshooting

Procedure

Table 7-4 explains how to troubleshoot a chart rotation problem.

Table 7-4 Troubleshooting Chart Rotation Failure Symptoms

Step	What to do	How to do it or where to find the instructions
1	Check the chart installation.	Turn the chart until the desired time line on the chart is aligned with the time index on the chart plate and pen 1 before closing the locking clip on the hub. Push down on the lifter to return the pen(s) to the chart. CAUTION: Do not try to rotate the hub
2	Check the settings of the configuration switches. Change settings if incorrect for application.	Refer to <i>Section 3 – Configuration, Startup, and Operation of Recorder without Display</i> .
3	Run the step test.	Refer to <i>Section 3 – Configuration, Startup, and Operation of Recorder without Display (Subsection 3.3.3)</i> .
4	Check the motor cable plug connection at connector P3 on the printed circuit assembly for pen 1.	Power down the recorder, then visually examine the plug and reseal it.
5	Replace the chart motor.	Refer to the replacement procedure in <i>Section 9 – Replacing Hardware Assemblies</i> .
6	Replace the printed circuit board for pen 1.	Refer to the replacement procedure in <i>Section 9 – Replacing Hardware Assemblies</i> .

7.3.5 Troubleshooting Erratic Pen Movement

Procedure

Table 7-5 explains what to do if the pen remains at the high end of range when the input signal is low.

Table 7-5 Troubleshooting Erratic Pen Movement Symptoms

Step	What to do	How to do it or where to find the instructions
1	Check the sensor and lead wires for continuity. Check the connections to TB2 on the printed circuit assembly for the pen with the problem.	Replace the sensor lead wires as needed. Tighten the connections.
2	Check the pen and input configuration data.	Refer to <i>Section 3 – Configuration, Startup, and Operation of Recorder without Display</i> .
3	Run step test.	Refer to <i>Section 3 – Configuration, Startup, and Operation of Recorder without Display (Subsection 3.3.3)</i> .
4	Replace the servo plate assembly.	Refer to the replacement procedure in <i>Section 9 – Replacing Hardware Assemblies</i> .
5	Replace the printed circuit assembly for the pen having the problem.	Refer to the replacement procedure in <i>Section 9 – Replacing Hardware Assemblies</i> .

7.4 Alignment of Pen at Zero and 100 %

Procedure

You can align the pens to the zero and 100 % positions on the chart using the procedure in Table 7-6. If humidity causes the chart to change size, repeat the procedure as needed.

WARNING





SHOCK HAZARD

When the unit is powered a potentially lethal shock hazard exists at the AC line connections at TB1 on each printed circuit assembly (behind the chart plate). Make sure the unit power is disconnected before starting the procedure. More than one switch may be required to de-energize the recorder.

Failure to observe this precaution can result in exposure to a potentially lethal shock hazard.

Table 7-6 Procedure for Pen Alignment

Step	Action	Graphic
1	Place run switch SW5 to the setup position (toward the top of the board) on the pen's PCA.	 See Figure 3-1 for location of SW5 (to the right of TB1).
2	Press SW3 and SW4 simultaneously and release them. The pen will move downscale toward the hub and be positioned at the previously set 0 % point on the chart within approximately 10 seconds.	See Figure 3-1 for location of SW3 and SW4.
If the pen tip is greatly out of position, follow Steps 3 through 7. (Unless a pen arm has been replaced, this probably will not be necessary.) If pen position requires only minor adjustment, go to Step 8.		
3	Turn off the power to the recorder before the pen begins to move upscale (approximately 10 seconds).	
4	To place the pen tips in approximately the correct position, loosen the screw holding the pen 1 arm to the servo shaft and move the pen arm to access the locking screw for the pen 2 arm (if applicable).	
5	Align the tip of pen 2 with the zero line on the chart and tighten the locking screw.	
6	Align the tip of pen 1 with the zero line on the chart and tighten the locking screw.	
7	Turn on the power and repeat Step 2.	
8	To fine-tune the alignment of a pen, press the raise switch SW4 or lower switch SW3 on its PCA until the pen tip is aligned with the zero line on the chart. Approximately 10 seconds after the last press of the raise or lower switch the pen will move to the previously set 100 % point.	See Figure 3-1 for the location of SW3 and SW4.

Step	Action	Graphic
9	<p>To fine-tune the alignment of the pen, press the raise switch SW4 or lower switch SW3 until the pen tip is aligned with the 100 % line on the chart.</p> <p>Approximately 10 seconds after the last press of the raise or lower switch the pen will move downscale as described in Step 2.</p>	<p>See Figure 3-1 for the location of SW3 and SW4.</p>
10	<p>To exit the pen alignment cycle place SW5 to the run position (toward the bottom of the board). Pen will return to normal operation.</p>	

8. Troubleshooting and Pen Alignment of Recorder with Display

8.1 Overview

Introduction

This section explains how to troubleshoot the recorder models having display and keypad. Troubleshooting uses self-diagnostic test results and error messages as well as some observable symptoms of failure.

- To reduce recorder down-time, this section enables tracing trouble to a printed circuit assembly (PCA)/hardware assembly level rather than to an individual component.
- While troubleshooting is straightforward, we recommend that only trained service technicians repair the recorder. **SEE THE SHOCK HAZARD WARNING BELOW.**

This section also includes instructions for aligning the pens

What's in this section?

The following is a list of the topics covered in this section.

Topic	See Page
8.1 Overview	171
8.2 Troubleshooting Aids	173
8.3 Self Diagnostics	174
8.4 Observable Symptoms of Failure	179
8.5 Troubleshooting Procedures	180
8.6 Alignment of Pen at Zero and Span	188



WARNING—SHOCK HAZARD



TROUBLESHOOTING MAY REQUIRE ACCESS TO HAZARDOUS LIVE CIRCUITS, AND SHOULD ONLY BE PERFORMED BY QUALIFIED SERVICE PERSONNEL. MORE THAN ONE SWITCH MAY BE REQUIRED TO DE-ENERGIZE UNIT BEFORE SERVICING.

Types of problems

Instrument performance can be adversely affected by installation and application problems as well as by hardware problems. We recommend that you investigate the problems in the order listed below, and use the information in this section to solve them. If replacement of any part is required, follow the procedures in *Section 9 – Replacing Hardware Assemblies*.

- Installation related problems
- Application related problems
- Hardware and software related problems

Installation related problems

Read *Section 2 – Installation* to make sure the recorder has been properly installed. Document 51-52-05-01 *How to Apply Digital Instrumentation in Severe Electrical Noise Environments* can provide additional relevant information.

ATTENTION

System noise induced into the recorder will result in diagnostic error messages recurring. If the diagnostic error messages can be cleared, it indicates a “soft” failure and is probably noise related.

If system noise is suspected, completely isolate the recorder from all field wiring. Use calibration sources to simulate PV and check all recorder and control functions; that is, pen functions, chart trace, output, alarms, etc.

Application related problems

Review the application of the recorder; then, if necessary, direct your questions to the local sales office.

Hardware and software related problems

Use the troubleshooting error messages and observable symptoms to identify typical failures which may occur in the recorder. Follow the troubleshooting procedures to correct the problems.

8.2 Troubleshooting Aids

Self diagnostics

The software runs self-diagnostic tests to monitor the recorder's general state. Tests are run when the unit is powered up and as a background task during operation.

When tests run at power-up, the progress of the tests will be displayed as described in Subsection 8.3.1.

When the tests run in the background during normal operation, the display will not indicate the progress of the tests. However, if the recorder fails a test, an error message will appear on the lower line of the display as described in Subsection 8.3.4. Table 8-4 lists all the possible error messages, the reason for each, and how to correct the problem.

Observable symptoms of failure

Other failures may occur that deal with the power, pen functions, chart rotation, output, or alarms. If erratic operation is observed, refer to the failure symptoms in Table 8-5, then follow the appropriate troubleshooting procedure in Subsection 8.5.







Check Installation

If a set of symptoms still persists, refer to *Section 2 – Installation* and *Section 4 – Configuration, Startup, and Operation of Recorder with Display* to ensure that the recorder has been installed and set up properly.

Determine the software version before calling for technical support

Before calling for technical support, follow the procedure in Table 8-1 to determine the version of the software in the recorder. This version information will assist the support team in diagnosing the problem.

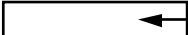
Table 8-1 Procedure for Identifying the Software Version

Step	Operation	Press	Action/Result
1	Select STATUS Set Up Group		Until you see: Upper Display  Lower Display 
2	Read the software version		Until you see: Upper Display  ← Software version Number Lower Display  Please give this number to the Customer Support person assisting you.

8.3 Self Diagnostics

8.3.1 Power up tests

Tests run automatically

When the recorder is powered-up, self-diagnostics are run by the software.

As the tests in Table 8-2 are run, the display indicates whether the tests were passed or failed as described below.

Table 8-2 Power-Up Diagnostic Tests

Lower Display	Upper Display
RAMTST	PASS or FAIL
CFGTST (configuration checksum)	PASS or FAIL
CALTST (working calibration)	PASS or FAIL

Status of tests displayed

As the tests are run, the lower line of the display shows which test is running. The upper line of the display indicates the status. If any of these tests fail, “FAIL” appears momentarily in the upper display, then a display test is run. The display changes to show the value of the process variable on the top line, and the error message for the failed test on the second line.

In addition, if the control group parameter “CONTRL” has a value of “ENAB” when the test is failed, the message “FAILSF” (failsafe) will alternate with error message for the test, and the controller will be in manual mode. When the “FAILSF” message is displayed, it indicates that the recorder control output has been driven to the value assigned to the control group “FAILSF” parameter.

By default, when the recorder is powered up the display will be for pen 1. Therefore, when the power up tests run, the “PASS” and “FAIL” messages will apply only to the printed circuit assembly associated with pen 1. However, in a 2-pen recorder the tests will also be run on the printed circuit assembly for pen 2. If the pen 2 assembly fails one of the tests, the message “P2 ERR” will be displayed, along with any error messages from the pen 1 tests.

8.3.2 View Status of Tests

Procedure

The status of self-diagnostic tests can be viewed using the procedure in Table 8-3.

Note that “FAILSF” is not a test. When “FAILSF YES” is displayed, it is an indication that the recorder is using the value of the control set up group “FAILSF” parameter as the output value because the recorder failed a self-test, or because the recorder detected an input failure while the input set up parameter “BRNOUT” = “NONE”.

See Table 8-4 for more information about self-diagnostics, and for recommended actions when a test fails.

Table 8-3 Procedure for Displaying the Results of Self-Diagnostics

Step	Operation	Press	Action/Result
1	Select STATUS set up Group	SET UP	Until you see: Upper Display READ Lower Display STATUS
2	Read the status tests results	FUNC	Until you see: Upper Display NO or YES YES indicates a failure Lower Display FAILSF <ul style="list-style-type: none"> Successive presses of the FUNC key will display the results of the status tests (PASS or FAIL) in the following order: RAMTST CFGTST CALTST Identify the problem and correct the failure as shown in Table 8-4.

8.3.3 Background Tests

Tests run automatically

During normal operation of the recorder, tests of the configuration and calibration run in the background. If the recorder fails one of the tests, the appropriate message will be displayed as described in Subsection 8.3.4.

8.3.4 Error Messages

All relevant messages are displayed

If the recorder fails one or more tests, the operator is alerted by the display of one or more messages.* One message is displayed at a time on the lower line of the display.

If the problem is with the pen channel input or printed circuit assembly for which real time values are currently on display, the appropriate error message for each failed test will be displayed. The display will continue to cycle through the messages until the test is passed.

If the failure is for the pen channel not on display, then a message will alert the operator to the existence of one or more error messages for the other pen. The message is “Pn ERR”, where n is the number of the pen with errors not on display. Once the operator has toggled the display to the pen channel whose input or printed circuit assembly was the source of the error, the display will cycle through the appropriate error messages.

Error messages are listed in Table 8-4, along with the type of test to which each applies, the reason for the failure, and how to correct the problem.

ATTENTION

In addition to error messages, the recorder will display special status messages when optional features are active.

- **If the lower display flashes “TUNING”, the recorder is in the process of automatically determining tuning parameters using the Accutune II feature described in Appendix D.**
 - **If the lower display flashes “RUN n” or “HOLD”, the recorder is executing setpoint program “n” as described in Appendix C, and the run or hold action was initiated locally.**
 - **If the lower display flashes “run n” or “hold”, the recorder is executing setpoint program “n”, and the run or hold action was initiated remotely.**
-

If you are familiar with the operation of the recorder models without display, you are aware that in those models the red LED on the printed circuit assembly lights when the unit fails a self-diagnostic, or detects an out-of-range input. **The red LED has a different function in the models with display and keypad.** It is **not** an indication of a problem. In the models with display the red LED indicates that the display is currently interfacing with this PCA. Rely on the error messages to notify you of a problem with a recorder with a display. (The flashing green LED is an indication that the processor is active.)

Table 8-4 Error Messages

Lower Display Indication	Type of Test	Reason For Failure	How to Correct the Problem
CALERR	power-up background	The working calibration constants in the recorder are in error or corrupted in memory.	<ol style="list-style-type: none"> 1. Use the procedure in Subsection 4.5.2.5 to switch between the set of calibration constants being used (factory or field) to the other type. Exit configuration mode. Next go back into configuration mode and change back to the original type of constants used (factory or field). This will overwrite the corrupted values in memory. 2. Change the setting of the "IN TYP" parameter and exit configuration mode. Go back into configuration mode and change the "IN TYP" setting back to the correct type.
CFGERR	power-up background	Configuration data is in error.	<ol style="list-style-type: none"> 1. Check all configuration parameter values for accuracy. (See <i>Section 4 – Configuration, Startup, and Operation of Recorder with Display.</i>) 2. Make a change to configuration, then exit configuration, so the recorder will recalculate the checksum error.
EEFAIL	background	Unable to write to nonvolatile memory. Anytime you change a parameter and it is not accepted, you will see EE FAIL.	<ol style="list-style-type: none"> 1. Try to change something in configuration. 2. Cycle the power. 3. If problem persists, replace printed circuit assembly for the channel.
FAILSF	power-up background	<p>This error message is displayed whenever the recorder is using the value of the control group "FAILSF" parameter as an output. For this to occur, the recorder must have control enabled (control group parameter "CONTRL" = "ENAB") when one or more of the following occur:</p> <ul style="list-style-type: none"> • RAM test fails • Configuration test fails • Calibration test fails • Input parameter "BRNOUT" = "NONE" and the input fails. 	<ol style="list-style-type: none"> 1. Check the operation of the input sensor. 2. Run through STATUS check to determine the reason for the failure. <ul style="list-style-type: none"> • Press the SET UP key until STATUS appears in the lower display. • Press the FUNC key to see what tests pass or fail, then run through the STATUS codes a second time to see if the error cleared. • Correct according to the recommendations given in this table.

Lower Display Indication	Type of Test	Reason For Failure	How to Correct the Problem
INP FL	background	Recorder detects an input failure. Two consecutive failures of input 1 integration (for example, recorder cannot make analog to digital conversion.)	<ol style="list-style-type: none"> 1. Be sure the range and actuation are configured correctly. 2. Check the input source. 3. See input set up group in <i>Section 4 – Configuration, Startup, and Operation of Recorder with Display</i> and change the “IN TYP” or “LD CAL” to a different type. Enter it, loop through the status tests, then return the input type to the original one. 4. Recalibrate if step 3 does not clear the error. Refer to <i>Section 5 – Input and Output Calibration for Recorder with Display</i>. 5. Replace the printed circuit assembly for the pen.
INPRNG	background	Input out of range. The process input is outside the range limits.	<ol style="list-style-type: none"> 1. Make sure the range and actuation are configured properly. 2. Check the input source. 3. See <i>Section 4 – Configuration, Startup, and Operation of Recorder with Display</i> to restore the factory or field calibration, as applicable. 4. Field calibrate using the procedure in <i>Section 5 – Input and Output Calibration for Recorders with Display</i>. 5. Replace the printed circuit assembly for the pen.
P1 ERR P2 ERR	power-up background	<p>Indicates that one or more error messages are active for the pen channel for which values are not on display.</p> <p>For example, if value of INP1 is on display, while the input for pen 2 fails, P2 ERR will be displayed. This alerts the operator to the need to switch the display to pen 2 to view the active error messages associated with that channel's input and printed circuit assembly.</p>	<ol style="list-style-type: none"> 1. Press the FUNC key to toggle to the other pen channel. 2. Watch the display to see all error messages for the active channel. 3. Follow the procedure in this table for each message displayed.
RAMTST	power-up	RAM failure	<ol style="list-style-type: none"> 1. Cycle power or press the reset switch SW2 to see if the error clears. 2. If error does not clear, replace the printed circuit assembly for the pen.

8.4 Observable Symptoms of Failure

Introduction

In addition to the error message prompts, there are observable symptoms of failure that can be identified by noting the erratic recorder functions.

Symptoms

Compare your recorder's symptoms with those shown in Table 8-5 and refer to the indicated subsection for the appropriate troubleshooting procedure.

Table 8-5 Observable Symptoms of Failure

Symptom	See Subsection
Recorder will not operate.	8.5.2
Recorder operation is normal but pen trace is incorrect.	8.5.3
Chart rotates at wrong speed or will not rotate (pen indication correct).	8.5.4
Pen remains at high end of range when input signal is low.	8.5.5
A key does not respond and/or a display does not light.	8.5.6
Displayed output does not agree with controller output.	8.5.6
External alarm function does not operate properly.	8.5.8
Digital input function does not operate properly.	8.5.9
Modbus communications are not successful.	8.5.10

8.5 Troubleshooting Procedures

8.5.1 Overview

Introduction

The troubleshooting procedures for the observable symptoms of failure are presented in the same order as they appear in Table 8-5. Each procedure includes what to do if you have that particular failure, as well as instructions for accomplishing the task, or a cross-reference to instructions elsewhere in the manual.

Equipment needed

You will need the following equipment in order to troubleshoot the symptoms listed in the tables that follow:

- DC Milliammeter – mA DC
- Calibration sources – T/c, mV, Volt, etc.
- Voltmeter

Safety precautions

Exercise appropriate safety precautions when troubleshooting the recorder operation.



WARNING—SHOCK HAZARD



TROUBLESHOOTING MAY REQUIRE ACCESS TO HAZARDOUS LIVE CIRCUITS, AND SHOULD ONLY BE PERFORMED BY QUALIFIED SERVICE PERSONNEL. MORE THAN ONE SWITCH MAY BE REQUIRED TO DE-ENERGIZE UNIT BEFORE SERVICING.

8.5.2 Recorder Failure Troubleshooting

Procedure

Table 8-6 explains how to troubleshoot recorder failure symptoms.

Table 8-6 Troubleshooting Recorder Failure Symptoms

Step	What to do	How to do it or where to find the instructions
1	Check the supply voltage.	Measure the line voltage across the line and neutral connections at TB1 on the printed circuit assembly (PCA) on the right (for pen 1).
2	Check the connections to TB1 on the pen 1 PCA.	Refer to ac wiring procedures in <i>Section 2 – Installation</i> .
3	Check the system for brown-outs, heavy load switching, etc.; and conformance to installation instructions.	Refer to <i>Section 2 – Installation</i> .
4	Replace the PCA for pen 1.	Refer to the replacement procedures in <i>Section 9 – Replacing Hardware Assemblies</i> .

8.5.3 Pen Trace Troubleshooting

Procedure

Table 8-7 explains how to troubleshoot a problem with the pen trace not matching the (correct) displayed value, assuming that the pen channel is configured to trace the input value.

Table 8-7 Troubleshooting Pen Trace Failure Symptoms

Step	What to do	How to do it or where to find the instructions
1	Check the ink cartridge for proper installation.	Reposition or replace the ink cartridge as described in <i>Section 6 – Routine Maintenance</i> . If the pen arm is severely warped, replace the pen arm as described in <i>Section 9 – Replacing Hardware Assemblies</i> .
2	Check that the chart agrees with the actuation type and check chart and pen set up.	Replace wrong chart with correct chart. Refer to <i>Section 4 – Configuration, Startup, and Operation of Recorder with Display</i> for instructions for viewing the configuration. See <i>Section 6 – Routine Maintenance</i> for instructions for replacing the chart.
3	Check the pen alignment	Follow the procedure in Subsection 8.6.
4	Check the sensor for the proper type and its ability to function.	Verify the input configuration data and operation of the sensor. Measure input signal at TB2 or apply calibration source to verify input signal.
5	Replace the servo plate assembly.	Refer to the replacement procedure in <i>Section 9 – Replacing Hardware Assemblies</i> .
6	Replace the printed circuit assembly for the pen with the problem.	Refer to the replacement procedure in <i>Section 9 – Replacing Hardware Assemblies</i> .

8.5.4 Chart Rotation Troubleshooting

Procedure

Table 8-8 explains how to troubleshoot a chart rotation problem.

Table 8-8 Troubleshooting Chart Rotation Failure Symptoms

Step	What to do	How to do it or where to find the instructions
1	Check the chart installation.	Turn the chart until the desired time line on the chart is aligned with the time index on the chart plate and pen 1 before closing the locking clip on the hub. Push down on the lifter to return the pen(s) to the chart. CAUTION: Do not try to rotate the hub
2	Check the configured chart speed value and change it, if required.	Refer to <i>Section 4 – Configuration, Startup, and Operation of Recorder with Display</i> .
3	Run the step test.	Refer to <i>Section 4 – Configuration, Startup, and Operation of Recorder with Display (Subsection 4.4.3)</i> .
4	Check the motor cable plug connection at connector P3 on the printed circuit assembly for pen 1.	Power down the recorder, then visually examine the plug and re-seat it.
5	Replace the chart motor.	Refer to the replacement procedure in <i>Section 9 – Replacing Hardware Assemblies</i> .
6	Replace the printed circuit board for pen 1.	Refer to the replacement procedure in <i>Section 9 – Replacing Hardware Assemblies</i> .

8.5.5 Troubleshooting Erratic Pen Movement

Procedure

Table 8-9 explains what to do if the pen remains at the high end of range when the input signal is low.

Table 8-9 Troubleshooting Erratic Pen Movement Symptoms

Step	What to do	How to do it or where to find the instructions
1	Check the sensor and lead wires for continuity. Check the connections to TB2 on the printed circuit assembly for the pen with the problem.	Replace the sensor lead wires as needed. Tighten the connections.
2	Check the pen and input configuration data.	Refer to <i>Section 4 – Configuration, Startup, and Operation of Recorder with Display</i> .
3	Run step test.	Refer to <i>Section 4 – Configuration, Startup, and Operation of Recorder with Display (Subsection 4.4.3)</i> .
4	Replace the servo plate assembly.	Refer to the replacement procedure in <i>Section 9 – Replacing Hardware Assemblies</i> .
5	Replace the printed circuit assembly for the pen having the problem.	Refer to the replacement procedure in <i>Section 9 – Replacing Hardware Assemblies</i> .

8.5.6 Troubleshooting the Keypad and Display

Procedure

Table 8-10 explains what to do if a key does not respond and/or the display does not light.

Table 8-10 Troubleshooting Keypad and/or Display Failure Symptoms

Step	What to do	How to do it or where to find the instructions
1	Run a Key Test to check the operation of the keys and displays.	Refer to <i>Section 4 – Configuration, Startup, and Operation of Recorder with Display</i> for procedure for running key test (<i>Subsection 4.4.4.4</i>).
2	Verify correct alignment of display cable with pins on connector at display module and main PCA.	Insure tracks on cable are aligned with pins on connector.
3	Replace the display and keypad assembly or display cables, as required.	Refer to the replacement procedure in <i>Section 9 – Replacing Hardware Assemblies</i> .

8.5.7 Troubleshooting Relay Output

Procedure

Table 8-11 explains what to do if the displayed output does not agree with the single relay or dual relay control output.

Table 8-11 Troubleshooting Relay Output Failure Symptoms

Step	What to do	How to do it or where to find the instructions
1	Be sure the recorder is configured for relay output.	Refer to <i>Section 4 – Configuration, Startup, and Operation of Recorder with Display</i> .
2	Be sure all the recorder and control related data is correct.	Refer to <i>Section 4 – Configuration, Startup, and Operation of Recorder with Display</i> .
3	Check that the applicable output relay actuates properly. If it does, go to step 4.	Put the recorder into manual mode and adjust the output manually to raise or lower the PV around the setpoint. Listen for the click of the relay as the PV moves in either direction. Observe OUT 1 or OUT 2 value on the front display.
4	Check the field wiring.	Refer to <i>Section 2 – Installation</i> .
5	Replace the relay.	Refer to <i>Section 9 – Replacing Hardware Assemblies</i> .
6	Replace the printed circuit assembly for the pen channel having the problem.	Refer to the replacement procedure in <i>Section 9 – Replacing Hardware Assemblies</i> .

8.5.8 Troubleshooting External Alarm Function

Procedure

Table 8-12 explains what to do if the external alarm function does not operate properly.

Table 8-12 Troubleshooting External Alarm Function Failure Symptoms

Step	What to do	How to do it or where to find the instructions
1	Be sure all the alarm configuration data is correct.	Refer to <i>Section 4 – Configuration, Startup, and Operation of Recorder with Display</i> .
2	Check the field wiring.	Refer to <i>Section 2 – Installation</i> .
3	Check that the applicable alarm relay actuates properly depending on ALARM TYPE configuration selection.	Alarms can be triggered either by: <ul style="list-style-type: none"> reconfiguring the value of the trip points (AnSnVA), [n = 1 or 2], or connecting a signal generator to the input and setting the generator level beyond the trip-point values.

8.5.9 Troubleshooting Remote Switch (Digital Input) Function

Procedure

Table 8-13 explains what to do if the digital input function does not operate properly.

Table 8-13 Troubleshooting Remote Switch (Digital Input) Function Failure Symptoms

Step	What to do	How to do it or where to find the instructions
1	Be sure all remote switch configuration data is correct.	Refer to <i>Section 4 – Configuration, Startup, and Operation of Recorder with Display</i> . See section for pen parameters set up group or remote switch set up group.
2	Check the field wiring.	Refer to <i>Section 2 – Installation</i> .
3	Check that the applicable remote switch actuates properly depending on REMOTE SWITCH configuration selection.	Remote switch actuates either by: <ul style="list-style-type: none"> reconfiguring PENIN for REM1 or REM2, or reconfiguring REM SW for SP2, MAN, or MNFS on REMSW1 or REMSW2.

8.5.10 Troubleshooting Modbus Communications

Procedure

Table 8-14 explains what to do if Modbus communications are not successful.

Table 8-14 Troubleshooting Modbus Communications

Step	What to do	How to do it or where to find the instructions
1	Verify that communications are enabled.	Refer to <i>Section 4 - Configuration, Startup, and Operation of Recorder with Display</i> .
2	Check that the configured baud rate is correct.	Refer to <i>Section 4 - Configuration, Startup, and Operation of Recorder with Display</i> .
3	Check that the device address is correct. Each address must be unique. A recorder with two pens must have a unique address for each pen channel.	Refer to <i>Section 4 - Configuration, Startup, and Operation of Recorder with Display</i> .
4	Check that the communication wires are properly connected to the J3 connector on the communication printed circuit assembly (PCA).	Refer to <i>Section 2 - Installation</i> .
5	Verify that the communication cable connects J2 on the communication PCA to J3 on the PCA for Pen 1. The PCA for Pen 1 is on the right when facing the recorder. If communication is used for Pen 2, another communication cable must connect J1 on the communication PCA with J3 on the PCA for Pen 2.	Refer to <i>Section 9 - Replacing Hardware Assemblies</i> .
6	Replace the communication PCA.	Refer to the replacement procedure in <i>Section 9 - Replacing Hardware Assemblies</i> .

8.6 Alignment of Pen at Zero and Span

Introduction

If the pen trace does not track at the correct chart increment with a known input value, you can use the following procedure to adjust the pen travel at zero and span (full scale) to compensate for the effects of humidity on the chart size.









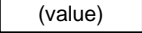
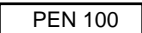

If the recorder has 2 pens, be sure Input1 (INP 1) is on the display. If it is not on display, press **FUNC** key to toggle input for display.

Procedure

Follow the procedure in Table 8-15 to align the pens.

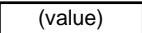
Table 8-15 Procedure for Aligning Pen at Zero and Span

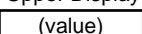
Step	Press	Action/Result
1	SET UP	until you can see: Upper Display ALIN Lower Display PEN
2	FUNC	until you can see: Upper Display (value) (approximately 60 on the upper display) Lower Display PEN0 Wait until pen stops moving downscale.
If the pen tip is greatly out of position, follow Steps 3 through 7. (Unless a pen arm has been replaced, this probably will not be necessary.) If pen position requires only minor adjustment, go to Step 8.		
3		Turn off the power to the recorder.
4		To place the pen tips in approximately the correct position, loosen the screw holding the pen 1 (purple) arm to the servo shaft and move the pen arm to access the locking screw for the pen 2 (red) arm (if applicable).
5		Align the tip of pen 2 with the zero line on the chart and tighten the locking screw.
6		Align the tip of pen 1 with the zero line on the chart and tighten the locking screw.
7		Turn on the power and repeat Step 2.

Step	Press	Action/Result
8	 or 	To set tip of pen 1 (purple) on zero scale line of chart $\pm 0.25\%$ (or quarter graduation).
9		and you will see: Upper Display  (value) (approximately 1200 more than the zero value in Step 2) Lower Display  Wait until pen stops moving upscale.
10	 or 	To set tip of pen 1 (purple) on full scale line of chart $\pm 0.25\%$ (or quarter graduation).
11		to return to normal operation for pen 1. you will see: Upper Display  (value) Lower Display  INP and the Input 1 indicator will be lit. If the recorder has 2 pens go to Step 12.
12		you will see: Upper Display  (value) Lower Display  INP and the Input 2 indicator will be lit. Repeat Steps 1, 2, and 8 through 11 for pen 2 (red).

9. Parts List

9.1 Overview

Introduction

This section provides the replacement parts lists for the DR4300 Circular Chart Recorder. Most parts are supplied on an optimum replacement unit basis; that is, part numbers are given for complete printed circuit assemblies rather than for individual PCA components.

The figures that follow are exploded views of the DR4300 recorder. Each part is labeled with a key number and the key numbers are listed in tables with associated part numbers.

When ordering parts, be sure to specify your recorder's serial and model numbers (on chartplate) as well as the part number.

Also included for your reference are an Internal Cabling drawing (Figure 9-4) and an Internal Wiring Diagram (Figure 9-5) for options only.

What's in this section?

The following is a list of the topics covered in this section.

Topic		See Page
9.1 Overview		191
9.2 Exploded Views		192
Figure 9-1	Door Assembly	192
Figure 9-2	Chart Plate	193
Figure 9-3	Recorder Components	194
9.2 Internal Cabling		
Figure 9-4	Internal Cabling CE Mark Version	196
Figure 9-5	Internal Cabling Non-CE Mark Version	197

9.2 Exploded Views

Door assembly

Figure 9-1 is an exploded view of the door assembly. Table 9-1 is a list of the associated part numbers.

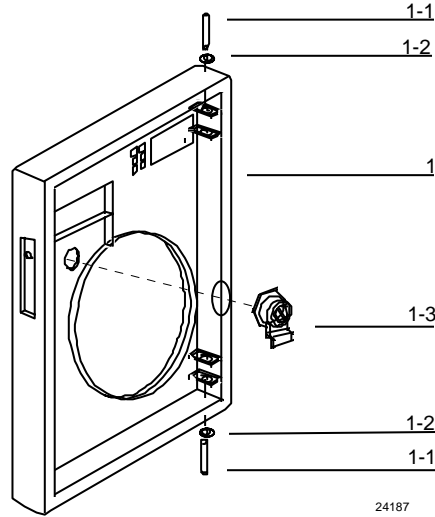

Figure 9-1 Door Assembly

Table 9-1 Door Assembly Parts

Key	Part Number	Description	Recommended Spare Parts Per		Quantity per Unit
			10	100	
1	51309609-501 51309609-502 51309609-506 51404778-501	Door Assembly (includes components for all door variations) Gray Door Blue Door Black Door NEMA4/Heavy Duty Door			1
1-1	(K)30756409-002	Hinge Pin*			2
1-2	(K)30756409-002	Retaining Ring*			2
1-3	51309609-503 51404673-501 30757307-503	Latch/Lock Assembly Kit* NEMA4/Heavy Duty Door Latch/Lock Assembly Kit* Key Only for Lock Assembly*	1	3	1
	51198139-501	Graphic Overlay for Door* (not shown)			1
	51309609-504	External Keypad Assembly Replacement Kit* (not shown)			1

*Parts included with applicable door assembly.

(K) denotes that the part number is for the parts kit in which the described part is included. The described part cannot be ordered separately.

Chart plate

Figure 9-2 is an exploded view of the chart plate assembly. Table 9-2 is a list of the associated part numbers.

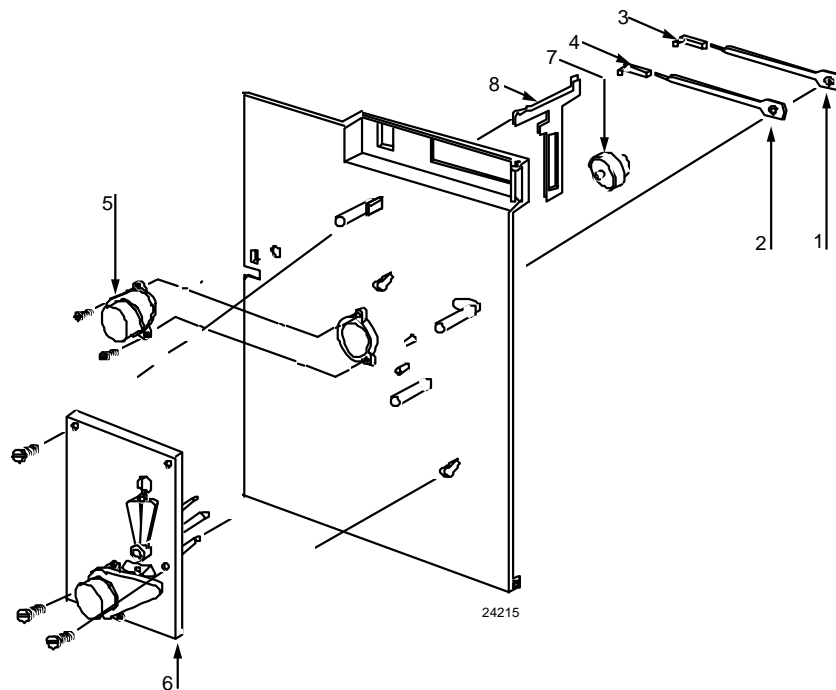

Figure 9-2 Chart Plate Assembly

Table 9-2 Chart Plate Assembly Parts

Key	Part Number	Description	Recommended Spare Parts Per		Quantity per Unit
			10	100	
1	(K)30756409-002	No. 1 Pen Arm	1	5	1
2	(K)30756409-002	No. 2 Pen Arm (2-pen model only)	1	5	1
3	30735489-007	No. 1 Purple Pen Cartridge (six pack)	1	3	1
4	30735489-002	No. 2 Red Pen Cartridge (six pack)	1	3	1
5	30756113-501	Chart Motor	1	3	1
6	30755833-501 30755833-502	Servo Plate Assembly 1-pen model 2-pen model			1
7	(K)30756150-501	Chart Hub Kit			1
8	(K)30756409-002	Pen Lifter Retainer			1

(K) denotes that the part number is for the parts kit in which the described part is included. The described part cannot be ordered separately.

Basic recorder components without options

Figure 9-3 is an exploded view of the recorder. Table 9-3 is a list of the associated part numbers.

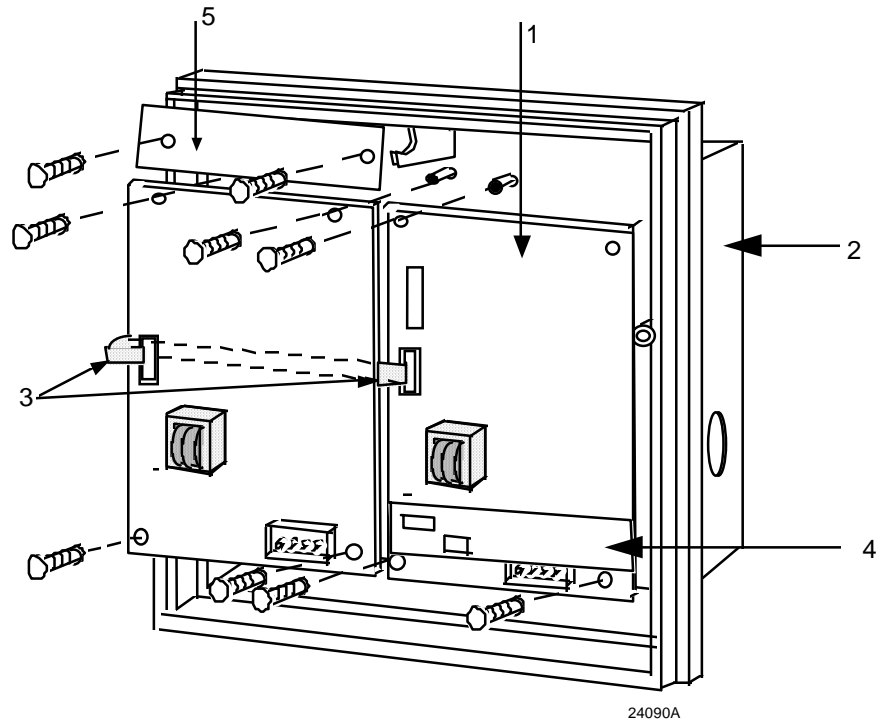

Figure 9-3 Recorder Components

Table 9-3 Basic Recorder Parts

Key	Part Number	Description	Recommended Spare Parts Per		Quantity per Unit
			10	100	
1	51404453-501	100 Vac to 240 Vac models Printed Circuit Assembly, Record Only	1	3	1/2
	51404453-502	Printed Circuit Assembly, Record and Control Spare Kit (includes solid state relay and open collector output)			
	51404453-505	Printed Circuit Assembly, FM-approved Limit Controller (includes solid state relay and open collector output)			
2	30755800-502	Case	1	3	1
3	51404511-501	Cable Replacement Kit	1	3	1
4	51404566-501	Digital Input Assembly	1	3	1/2
5	51404750-502	Modbus Communication Assembly	1	3	1/2
Parts Not Shown					
	51404459-501	Display Module Printed Circuit Assembly	1	3	1/2
	51404999-001	Hand Held Display Kit			
	51197612-502	Round cable suppression cores, package of 2	1	3	up to 3
	51197612-508	Round cable suppression cores, package of 8	1	1	1
	51198150-501	Pipe Mounting Kit, 2 inch size			
	30755306-501	Relay Kit - Electromechanical	1	10	2
	30756725-501	Relay Kit - Solid State	1	10	2
	30756679-501	Relay Kit - Open Collector	1	10	2
	51204403-501	Transmitter 24 V Power Supply Assembly			
	51404753-501	Filter assembly, CE version			
	51404546-501	Battery for Totalizer Option			
	30755065-001	Standard Mounting Bracket Kit			
	30755065-502	Heavy Duty/NEMA4 Mounting Bracket Kit			
	51197657-501	Panel Mount Gasket Kit			
	51205804-501	Terminal Block Kit			
Upgrade PROMs					
	51197993-501	Basic Recorder PROM, latest software version			
	51450899-501	Totalizer Upgrade PROM and Battery			
	51450899-502	PID Control Upgrade PROM			
	51450899-503	Auxiliary Output/Timer Upgrade PROM			

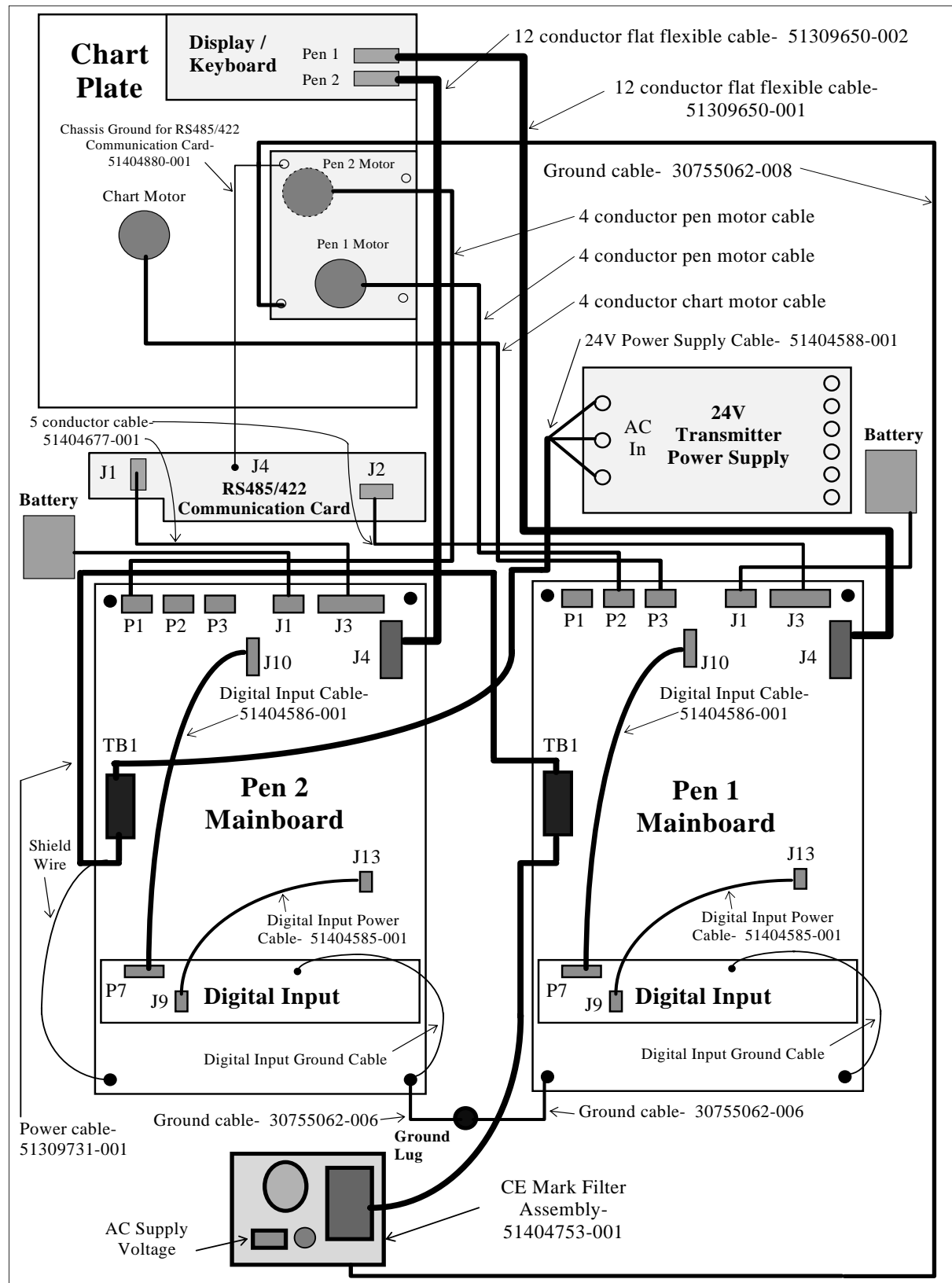

Figure 9-4 DR4300 Recorder (CE Mark) – Internal Cabling Diagram

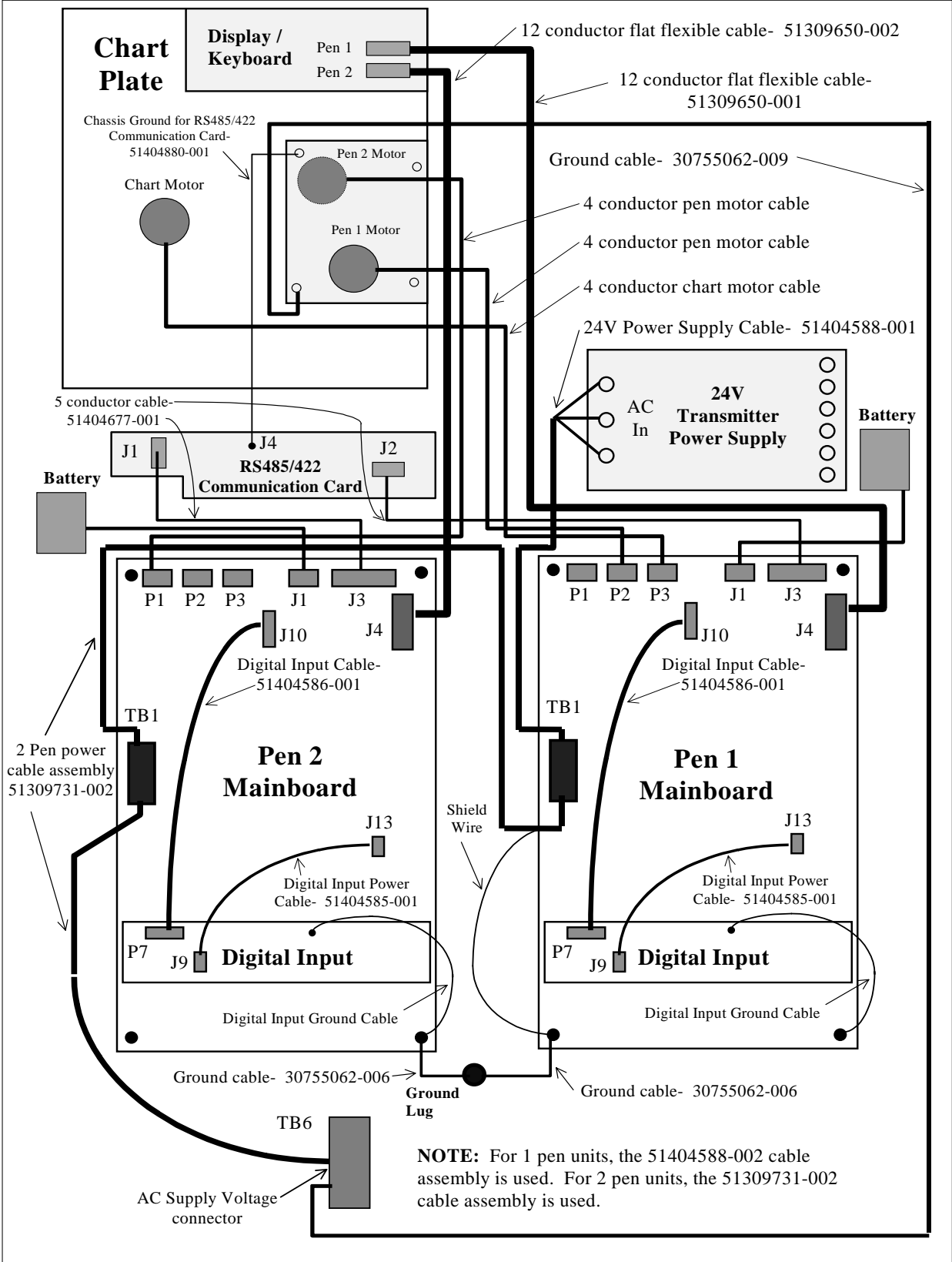

Figure 9-5 DR4300 Recorder (Non-CE Mark) – Internal Cabling Diagram

A. Accuracy

A.1 Overview

Reference accuracy

The reference accuracy varies according to the type of input actuation.

- Typical reference accuracy for each type of input is supplied in Subsection A.2.
- Factory accuracy may be improved by performing an input calibration (field calibration) as described in Section 5 (*Field calibration requires model with display*). The field-calibrated reference accuracy for each type of input actuation is also supplied in Subsection A.2. The figures include reference junction calibration of ± 0.01 degrees using the standard “ice bath” method of calibration.

A.2 Typical Reference Accuracy

Table A-1 Typical Reference Accuracy

Types of Input Actuators	Range		Reference Accuracy* with Field Calibration		Factory Accuracy*		Temp Stability ± Degrees Error Per 1 Degree ΔT	
	°F	°C	± °F	± °C	± °F	± °C		
Thermocouples B	105 to 3300	41 to 1816						
	150 to 500	66 to 260	56.0	32.0			4.00	
	500 to 1000	260 to 538	12.0	6.6	37	21	1.00	
	1000 to 3300	538 to 1815	6.0	3.4	18	10	0.40	
E	-454 to 1832	-270 to 1000						
	-454 to -202	-270 to -130	72.0	40.0	79	44	1.40	
	-202 to 1832	-130 to 1000	4.0	2.2	14	8	0.70	
E (low)	-200 to 1100	-129 to 593	2.0	1.2	11	6	0.40	
J	0 to 1600	-18 to 871	3.2	1.8	7	4	0.15	
J (low)	20 to 770	-7 to 410	1.6	1.0	6	3	0.08	
K	-320 to 2500	-196 to 1371	4.8	2.8	9	5	0.15	
K (low)	-20 to 1000	-29 to 538	2.0	1.2	7	4	0.10	
Ni-Ni Moly	32 to 2500	0 to 1317						
	32 to 500	0 to 260	3.0	1.6	12	7	0.21	
	500 to 2500	260 to 1371	2.0	1.2	9	5	0.14	
Nicrosil-Nisil	0 to 2372	-18 to 1200	4.2	2.4	11	6	0.20	
R	0 to 3100	-18 to 1704						
	0 to 500	-18 to 260	8.0	4.4	26	14	0.50	
	500 to 3100	260 to 1704	4.0	2.2	13	7	0.21	
S	0 to 3100	-18 to 1704						
	0 to 500	-18 to 260	8.0	4.4	23	13	0.50	
	500 to 3100	260 to 1704	4.0	2.2	13	7	0.21	
T	-420 to 700	-251 to 371	3.2	1.8	13	7	0.15	
T (low)	-200 to 600	-129 to 316	1.6	1.0	7	4	0.15	
W5W26	0 to 4200	-18 to 2316						
	0 to 600	-18 to 316	5.6	3.2	19	11	1.00	
	600 to 3600	316 to 1982	5.2	3.0	13	7	0.50	
	3600 to 4200	1982 to 2316	6.4	3.6	27	15	0.20	
RTD Platinum								
	100 ohms**	-300 to 900	-184 to 482	1.6	1.0	4	2	0.15
	100 ohms (low)**	-130 to 392	-90 to 200	1.2	0.6	3	2	0.15
	100 ohms (T)***	-238 to 482	-150 to 250	1.2	0.6	3	2	0.15

*Includes reference junction calibration of ± 0.01 degrees using the standard "ice bath" method of calibration. Factory accuracy at reference ± 1.2 °F. Note that factory accuracy may have typical variations of ± 150 microvolts or ± 0.6 ohms for RTDs which means field calibration may be required to achieve stated accuracy.

**IEC Alpha = 0.00385

***Alpha = 0.00391

Table A-1 Typical Reference Accuracy, Continued

Types of Input Actuations	Range	Reference Accuracy* with Field Calibration	Factory Accuracy*	Temp Stability ± Degrees Error Per 1 Degree ΔT
Linear Milliamperes dc	0 to 20	16 μA	80 μA	0.011 %/°F
	4 to 20	16 μA	80 μA	0.011 %/°F
Millivolts dc	0 to 10	10 μV	50 μA	0.011 %/°F
	0 to 100	100 μV	500 μA	0.011 %/°F
	0 to 200	200 μV	1.0 mV	0.011 %/°F
Volts dc	0 to 1	1 mV	5 mV	0.011 %/°F
	0 to 2	2 mV	10 mV	0.011 %/°F
	0 to 5	5 mV	25 mV	0.011 %/°F
	1 to 5	4 mV	20 mV	0.011 %/°F
	0 to 10	10 mV	50 mV	0.011 %/°F
	2 to 10	8 mV	80 mV	0.011 %/°F

*Includes reference junction calibration of ± 0.01 degrees using the standard "ice bath" method of calibration. Factory accuracy at reference ± 1.2 °F. Note that factory accuracy may have typical variations of ± 150 microvolts or ± 0.6 ohms for RTDs which means field calibration may be required to achieve stated accuracy.

**IEC Alpha = 0.00385

***Alpha = 0.00391

B. Available 10-inch Charts

B.1 Single Range Charts

Table B-1 lists the chart part numbers for the available 10-inch single range charts.

+ indicates the chart is used in Table 3-2 configurations; no mark indicates recorder with display is required.

Table B-1 10-inch Single Range Chart Part Numbers

Chart Type	Range	Units	24 HR P/N 24001660-XXX	7 DAY P/N 24001661-XXX
B Thermocouple	0 to 1800	C	135	
J Thermocouple	-18 to 425	C	028	028
	-45 to +150	C	027	027
	-50 to +300	F	019	019
	0 to 150	C	070 +	070 +
	0 to 200	F	114 +	
	0 to 250	C	024 +	024 +
	0 to 300	F	002 +	002 +
	0 to 300	C	062 +	062
	0 to 400	F	012 +	006
	0 to 400	C	063 +	063
	0 to 500	F	013 +	007 +
	0 to 600	F	003	008 +
	0 to 800	F	014 +	009 +
	0 to 1000	F	015 +	010 +
	0 to 1200	F	004 +	011 +
	0 to 1600	F	018 +	018 +
	10 to 340	C	057 +	057 +
	10 to 76	C	030	030
	50 to 1400	F	029	029
	50 to 650	F	056	056
100 to 260	C	094		
150 to 750	F		150	
810 to 910	F	230		

Chart Type	Range	Units	24 HR P/N 24001660-XXX	7 DAY P/N 24001661-XXX
K Thermocouple	-18 to 1320	C	031	031
	0 to 200	C	086 +	
	0 to 400	F	053 +	053
	0 to 400	C	064 +	064
	0 to 500	C	205 +	
	0 to 600	C	059 +	059
	0 to 800	C	060 +	060
	0 to 1000	F	007 +	016 +
	0 to 1000	C	049 +	049 +
	0 to 1200	F	006 +	012 +
	0 to 1200	C	065 +	
	0 to 1600	F	016 +	013 +
	0 to 2000	F	005 +	014 +
	0 to 2400	F	009 +	015 +
	800 to 1000	F	227	
R Thermocouple	0 to 1600	C	017 +	017
	0 to 2500	F	025 +	025 +
	30 to 2900	F	032 +	032 +
	800 to 1600	C	089	
S Thermocouple	0 to 1600	C	066	
	0 to 3000	F	147 +	147 +
T Thermocouple	-250 to +150	F		042 +
	-130 to +410	F	033 +	033 +
	-100 to +100	C	069	069 +
	-90 to +210	C	034 +	034 +
	0 to 100	C		100
	0 to 150	C	103 +	
	0 to 300	C		079
	+75 to -200	C		058 +
	+125 to -105	C	098	
W5W26 Thermocouple	0 to 1800	C	157 +	

Chart Type	Range	Units	24 HR P/N 24001660-XXX	7 DAY P/N 24001661-XXX
Linear	-200 to +200			199
	-100 to +200		232 +	178 +
	-100 to +100	F	201 +	
	-85 to +190		179 +	
	-75 to +260		178	179
	-60 to +215		088	
	-50 to +50			218 +
	-40 to +10			142
	-35 to +75	C	023 +	023 +
	-30 to +100	C	210	
	-30 to +20	F	204	
	-18 to 94		035	
	-10 to 100			149
	-5 to 50	C	022 +	197/022 +
	0 to .6			203
	0 to 1		211	202
	0 to 2	MG/L		217
	0 to 2	MGD	175	129
	0 to 5			074
	0 to 8		212	
	0 to 10		076	076
	0 to 14		036	036
	0 to 15		119	085
	0 to 20		071	071
	0 to 24	FEET		196
	0 to 25		095	095
0 to 30		040	040	
Linear (continued)	0 to 40		110	041
	0 to 45		078	
	0 to 50			051 +
	0 to 55		130	
	0 to 70			075 +
	0 to 80		120	
	0 to 100		001 +	001 +
	0 to 150		180 +	

Chart Type	Range	Units	24 HR P/N 24001660-XXX	7 DAY P/N 24001661-XXX
	0 to 200		010 +	004 +
	0 to 300		050 +	050 +
	0 to 350		037 +	037 +
	0 to 400		011 +	005 +
	0 to 500		104	
	0 to 600		052 +	
	0 to 750		223	
	0 to 800		137 +	
	0 to 1000		173 +	
	0 to 1200		054	108 +
	0 to 1600			109 +
	0 to 2000	F	202 +	
	0 to 2400	GPM		219
	0 to 2500		113 +	
	0 to 7000		123	
	0 to 8000		208	
	0 to 25000		111	
	1.3 to 1.8			
	5 to 9	PH		093
	10 to 20	METER	231	
20 to 120		039	039	
40 to 70			125	
Linear (continued)	50 to 70			141
	50 to 250		008 +	003 +
	70 to 140		038	038
	100 to 200		132	
	100 to 300	F	131	
	100 to 600	F	140	
	180 to 30	Reverse range		224
	1500 to 2500			
	2250 to 2500	F	209	
	1300 to 2600	F	203	
RTD-PT100 a=0.00391	-200 to +100	F	044	044
	-125 to +375	F	020 +	020 +

Chart Type	Range	Units	24 HR P/N 24001660-XXX	7 DAY P/N 24001661-XXX
	-100 to +50	C	091	
	-100 to +100	C	080	080
	-100 to +200	C	021	021
	-100 to +500	F	099	
	-85 to +190	C	047	
	-75 to +260	C	055	055
	-50 to +25	C	048	048
	-50 to +50	C	092	
	-30 to +170	F	087	087
	-25 to +125	C	045	045
	-20 to +30	F		117
	0 to -100	C		084
	0 to 120	C	144	
	0 to 150	C	122 +	
	0 to 250	C	068	
	0 to 400	C	081	081
	49 to -95	C		083
	50 to 100	C	061	
	50 to 150	C	116 +	116
		100 to 200	F	132
120 to -140		F	082	
180 to 30		F	121	
250 to 300		F	106	
RTD-PT100 a=0.00385	-100 to +100	C	080	080 +
	-40 to +60	C	067 +	067 +
	50 to 100		061	061
	50 to 120		134	
	0 to 60	C	161	
	0 to 250	C	068 +	
	0 to 400		081	081

B.2 Dual Range Charts

Table B-2 lists the chart part numbers for the available 10-inch dual range charts.

+ indicates the chart is used in Table 3-2 configurations.

Table B-2 10-inch Dual Range Chart Part Numbers

Calibration	Range 1	Range 2	24 HR P/N 24001660-XXX	7 DAY P/N 24001661-XXX
Linear/Linear	0 to 15	0 to 3,000,000	200	
	-100 to +200	35 to 0	600	600*
	0 to 200	63 to 0		602*
	0 to 2000	0 to 90		633*
	-18 to +94	35 to 0	603	
	-18 to +94	35 to 0		603
	-22 to +158	0 to 10	174*	
	0 to 50	0 to 100	606*	606
	0 to 60	0 to 100	138*	
	0 to 100	-30 to +70	601 +	601 +
	0 to 100	0 to 14	621*	
	0 to 100	-80 to +20		653* +
	40 to 140	30" Hg to 40 PSI		148*
	50 to 150	0 to 100	097	
	50 to 150	20 to 0	609	
50 to 150	0 to 100		097	
Linear %/Linear PH	0 to 100	0 to 14		213
Linear/K T/C Deg. F	0 to 10	0 °F to 2000 °F	640*	
Linear/RTD Deg. C	0 to 100	-87°C to +191 °C	145*	
Linear Deg. C/Linear	-40 °C to +150 °C	0 to 100 RH	660*	660*
Linear Deg. F/Linear % RH	0 °F to 120 °F	0 to 100	207	
Linear Deg. F/Linear	-40 °F to +300 °F	0 to 100 RH	661*	661*
Linear Deg. F/K T/C Deg. F	0 °F to 3000 °F	0 °F to 2000 °F	645*	
Linear Deg. F/Linear	32 °F to 122 °F	0 to 100		151*
Linear Deg. F/PSI Linear	0 °F to 1400 °F	0 to 5000		
Linear Deg. C/Linear	-18 °C to +37 °C	0 to 100		637* +
Linear GPM/Linear PH	0 to 100	0 to 14		214
	0 to 250	0 to 14		200
Linear PSI/Linear GPM	0 to 150	0 to 7800		204
J T/C Deg. F/Linear	0 °F to 600 °F	0 to 2000 PSI	647*	

Calibration	Range 1	Range 2	24 HR P/N 24001660-XXX	7 DAY P/N 24001661-XXX
J T/C Deg. C/K T/C Deg. C	0 °F to 300 °F	0 to 100	617*	617*
	0 °F to 300 °F	0 to 400	656*	
	0 °F to 400 °F	0 to 100	124*	
	0 °F to 400 °F	0 to 800	629*	
	0 °F to 600 °F	0 to 100	611*	
	0 °F to 300 °F	0 to 500	636*	
	-18 °C to +315 °C	-18 °C to +1315 °C	112*	
J T/C Deg. F/J T/C Deg. C	95 °F to 455 °F	35 °C to 235 °C	026*	026*
J T/C Deg. F/K T/C Deg. F	0 °F to 300 °F	0 °F to 1500 °F	186	
J T/C Deg. F	0 °F to 600 °F	0 °F to 2400 °F	604*	
K T/C Deg. F/J T/C Deg. F	1300 °F to 2000 °F	400 °F to 800 °F	649*	
J T/C Deg. F	0 °F to 300 °F	0 °F to 1600 °F	651*	
K T/C Deg. F/Linear	-100 °F to +900 °F	0 to 10	635*	
	0 °F to 2000 °F	0 to 2	163*	
	500 °F to 2000 °F	0 to 1.5	127*	
T T/C Deg. F/Linear	50 °F to 250 °F	0 to 100	643*	
	-50 °F to +300 °F	0 to 100		631*
T T/C Deg. C/Linear	-100 °C to +100 °C	0 to 100		162*
	-80 °C to +180 °C	0 to 100	657*	
RTD Deg. F/Linear	100 °F to 300 °F	0 to 160	152*	
RTD Deg. C/Linear	-5 °C to +50 °C	0 to 100		102*
	-10 °C to +60 °F	0 to 100		616*
	-35 °C to +75 °C	0 to 100		101*
	-76 °C to +100 °C	35 to 0	607*	
	-50 °C to +100 °C	0 to 100	638*	638*
	-76 °C to +100 °C	35 to 0		607*
	-75 °C to +180 °C	35 to 0	608*	
RTD Deg. C/Linear	-85 °C to +190 °C	0 to 100	154*	
	-85 °C to +190 °C	0 to 100	659*	
	12 °C to 93 °C	0 to 100	644*	
	50 °C to 150 °C	0 to 50	646*	

DR4300 Circular Chart Recorder

Calibration	Range 1	Range 2	24 HR P/N 24001660-XXX	7 DAY P/N 24001661-XXX
RTD Deg. F/Linear	-50 °F to +250 °F	0 to 1000		642* +
	0 °F to 300 °F	0 to 100	632*	
	100 °F to 300 °F	0 to 160	652*	
	-10 °F to +60 °F	0 to 100	616*	
RTD Deg. C/Linear	-100 °C to +200 °C	0 to 100	628*	628*
	-18 °C to +94 °C	0 to 100	155*	
RTD Deg. C/Linear PSIA	0 °C to 150 °C	0 to 25	222	
RTD Deg. C/RTD Deg. C	0 °C to 100 °C	50 °C to 120 °C		641*
	-23.3 °C to +93.3 °C	-87.2 °C to +177 °C	206	
RTD Deg. F/RTD Deg. F	14 °F to 122 °F	104 °F to 212 °F	619*	
RTD Deg. C/RTD Deg. C	-10 °C to +50 °C	40 °C to 100 °C	618*	

*minimum purchase required

C. Setpoint Ramp/Soak Programming and Operation

C.1 Overview

Introduction

As an option, the recorder can support the programming and execution of a setpoint program (profile). A total of twenty-four program segments are available, twelve ramp and twelve soak segments. In a ramp segment the setpoint value is changed as specified during configuration. The ramp is configured in terms of ramp time or ramp rate, depending on how you have configured the RPUNIT (ramp unit) parameter. During a soak segment the setpoint is held at the specified value.

Odd-numbered segments are always ramp segments. Even-numbered segments are always soaks. These ramp and soak segments can be used in up to four programs. You designate the beginning and end segments to determine where the program will start or stop.

- Every program must start with a ramp segment and end on a soak segment.
- Recorder must be set to use SP1 (setpoint 1)
- Only contiguous segments can be used by a program.
- There can be overlap between programs. For example, Program 1 could use Segments 1, 2, 3, 4, 5, and 6. Program 2 could be configured to begin with Segment 5 and end with Segment 8.

This appendix contains instructions for setting up a setpoint program, and for executing the program at runtime.

Note that Section 4 contains instructions for using the single setpoint ramp supported by all DR4300 models. **The SPRAMP (single setpoint ramp) parameter described in Section 4 must be set to DIS (disabled) if a setpoint program is to be used.**

ATTENTION

If power is lost during execution of a program, upon power-up the recorder will use the last setpoint value prior to the beginning of the setpoint program. The program is placed in hold at the beginning. The Manual/Auto mode will be as configured under "PWR UP" in the "CONTROL" group.

What's in this section?

This section contains the following information:

Topic	See Page
C.1 Overview	211
C.2 Program Contents	212
C.3 Drawing a Ramp/Soak Profile	214
C.4 Setpoint Program Prompt Hierarchy	218
C.5 Run/Monitor the Program	221

C.2 Program Contents

What you will configure

You will configure all the data that is relevant to each ramp and soak segment for a given setpoint versus time program (profile). The recorder will prompt you through the sequence of segments and associated functions. All prompts are listed, in sequence, in Table C-1.

Ramp unit

The ramp unit selection determines the engineering units for the ramp segments.

The selections are:

- TIME = Hours:Minutes
- EU-H = Degrees/Hour OR EU-M = Degrees/Minute

Recycle number

The recycle number allows the program to recycle a specified number of times from beginning to end.

- Range = 0 to 99

Program state

The program state selection determines the program state after completion.

The selections are:

- DIS = program is disabled
- HOLD = program on hold

Ramp time or rate segments

A ramp segment is used to change the setpoint to the next soak setpoint value in the program.

- Ramps are odd-numbered segments. Segment 1 will be the initial ramp.
- Ramps are specified in terms of either:

TIME* - Hours:Minutes Range = 0-99 hr:59 min

or

EU-M* - Degrees/Minute Range = 0 to 999

EU-H* - Degrees/Hour

* *The selection of time or rate is made at prompt "RP UNIT".*

Set this prompt before entering any Ramp information.

ATTENTION

Entering "0" will imply an immediate step change in setpoint to the next soak.

Soak segments

A soak segment is a combination of soak setpoint (value) and a soak duration (time).

- Soaks are even-numbered segments.
- Segment 2 will be the initial soak value and soak time.
- The soak setpoint range value must be within the setpoint high and low range limits in engineering units. (Specify the setpoint range with SP HI and SP LO in the control group as described in Section 4.)
- Soak time is the duration of the soak and is determined in:
TIME - Hours:Minutes Range = 0-99 hrs:59 min.
- At the conclusion of program execution, the recorder will use the setpoint achieved during the last soak segment.

Start segment number for each program

The start segment number designates the number of the first segment.

- Range = 1 to 23 (odd-numbered segments only)

End segment number for each program

The end segment number designates the number of the last segment, it must be a soak segment (even-numbered).

- Range = 2 to 24 (even-numbered segments only)

Guaranteed soak

A SOKDEV (soak deviation) parameter is provided. If its value is not zero, then soaking will be frozen for each segment until the difference (plus or minus) between PV and SP is less than or equal to the value of SOKDEV.

There are no guaranteed soaks whenever SOKDEV = 0. In this case, soak segments start timing soak duration as soon as the soak setpoint is first reached, regardless of where the process variable remains relative to the soak setpoint during the duration of the segment.

The decimal location corresponds to input 1 decimal selection.

Digital input (remote) operation

Program can be placed in RUN or HOLD state through a remote dry contact connected to optional digital input terminals. The REMSW1 and REMSW2 parameters must be configured to support this function. The valid values for those parameters are:

- RUN—contact closure places program in RUN state, and lower display will flash “run n”
- HOLD—contact closure places program in HOLD state, and lower display will flash “hold”

Opening contact reverts to original state.

C.3 Drawing a Ramp/Soak Profile

Ramp/soak profile example

Before you perform the actual configuration, we recommend that you draw your Ramp/Soak profiles in the space provided on the blank graphs and fill in the associated information on the worksheet. An example of a Ramp-Soak Profile using the first twelve segments for Program 1 is shown in Figure C-1. Start setpoint in this example is at 200 °F.

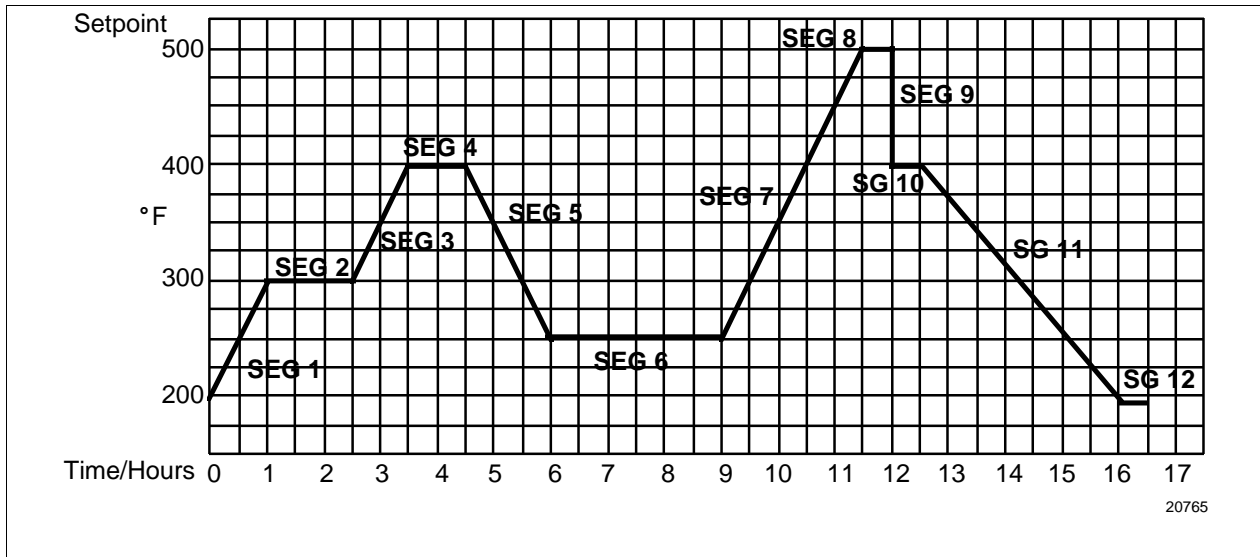
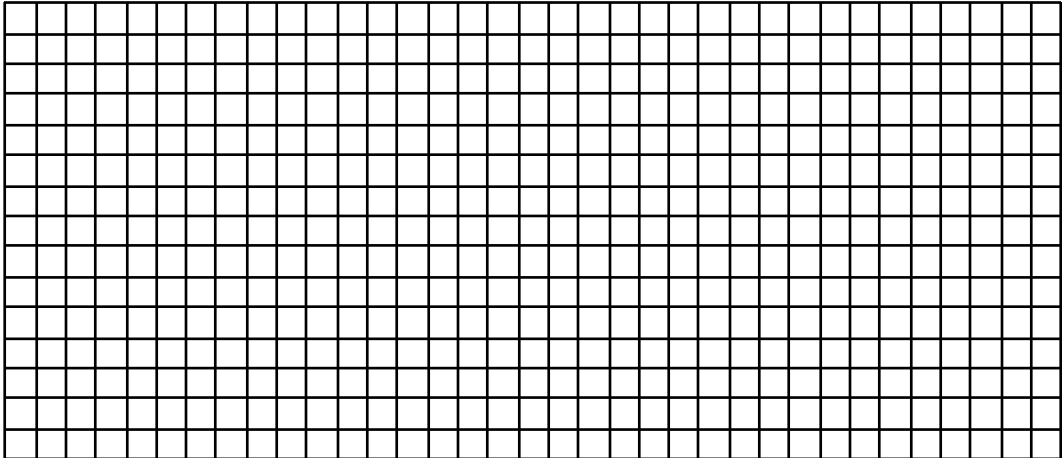

Figure C-1 Ramp/Soak Profile Example

Prompt	Function	Segment	Value	Prompt	Function	Segment	Value
START1	Start Seg.		1	SG6 SP	Soak SP	6	250
END 1	End Seg.		12	SG6 TI	Soak Time	6	3 hr:0 min
RECYCL	Number of Recycles		2	SG7 RP	Ramp	7	2 hr:30 min
SOKDEV	Deviation Value		0	SG8 SP	Soak SP	8	500
RP UNIT	Ramp Units		TIME	SG8 TI	Soak Time	8	0 hr:30 min
END ST	Program State at end		HOLD	SG9 RP	Ramp	9	0
SG1 RP	Ramp	1	1 hr	SG10SP	Soak SP	10	400
SG2 SP	Soak SP	2	300	SG10TI	Soak Time	10	0 hr:30 min
SG2 TI	Soak Time	2	1 hr:30 min	SG11RP	Ramp	11	3 hr:30min
SG3 RP	Ramp	3	1 hr	SG12SP	Soak SP	12	200
SG4 SP	Soak SP	4	400	SG12TI	Soak Time	12	0 hr:30 min
SG4 TI	Soak Time	4	1 hr				
SG5 RP	Ramp	5	1 hr:30 min.				

Profile graphs

Draw your ramp/soak profiles on the graphs below and fill in the associated information in the worksheet. This will give you a permanent record of your program and will assist you when entering the ramp and soak values.



20766

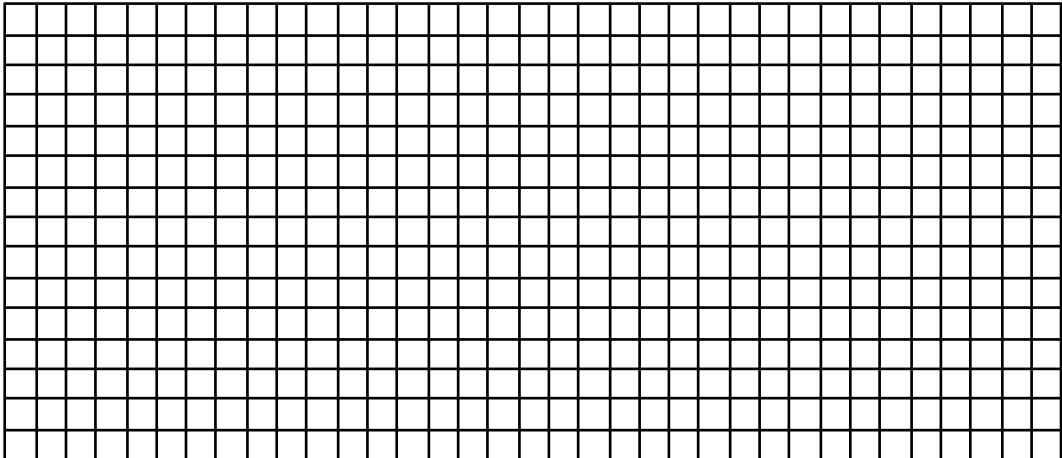

20766

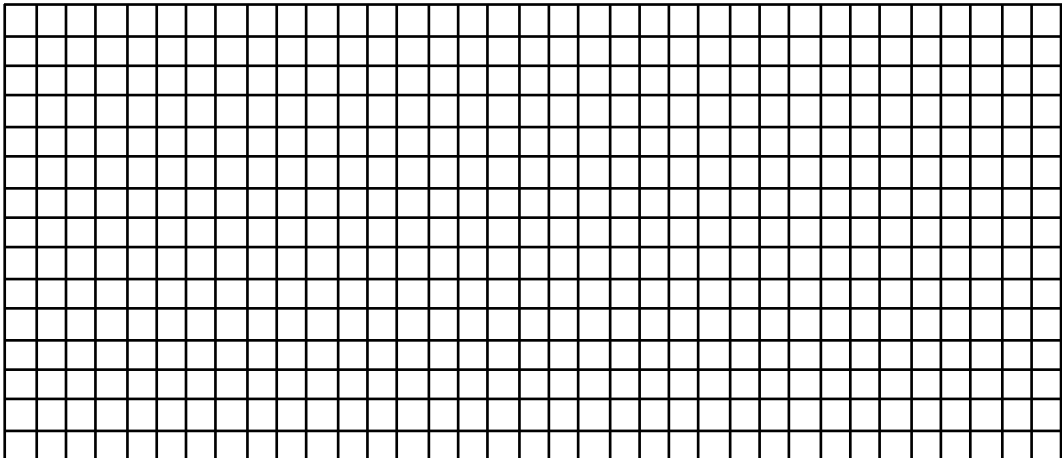

20766

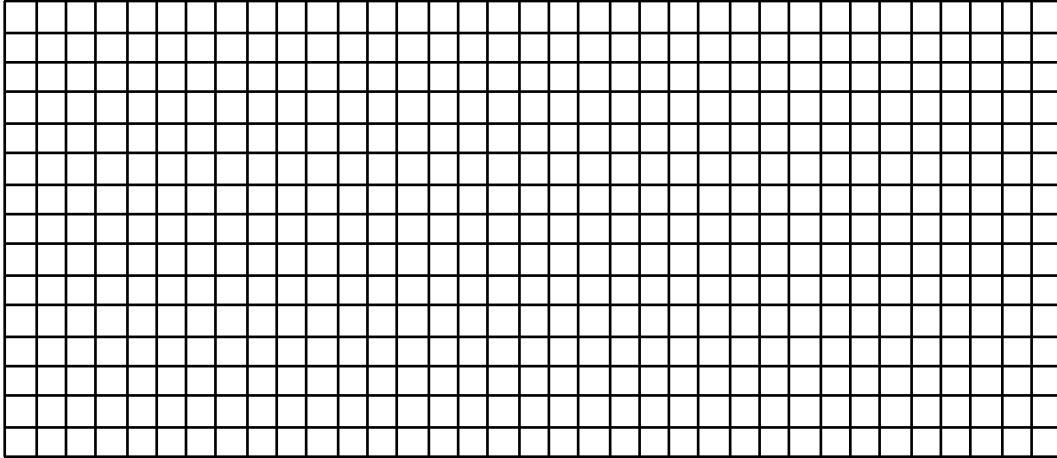

20766

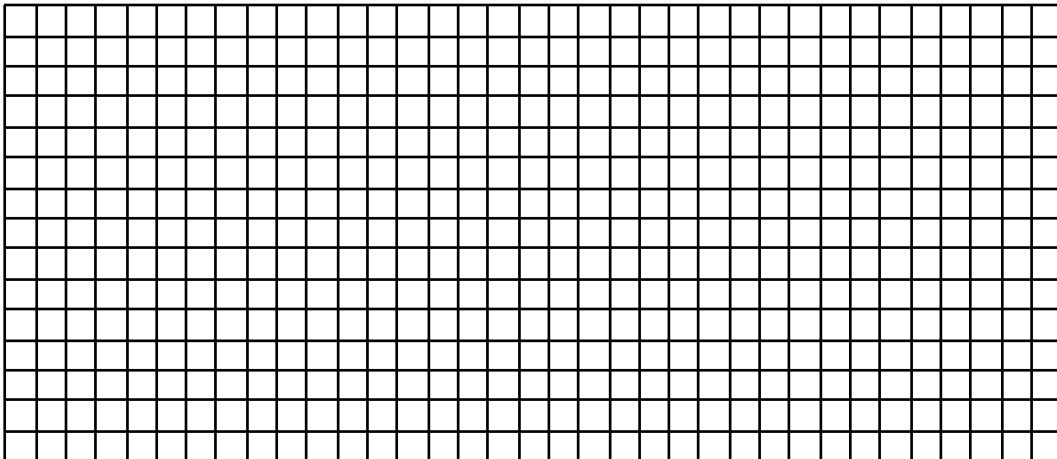

20766

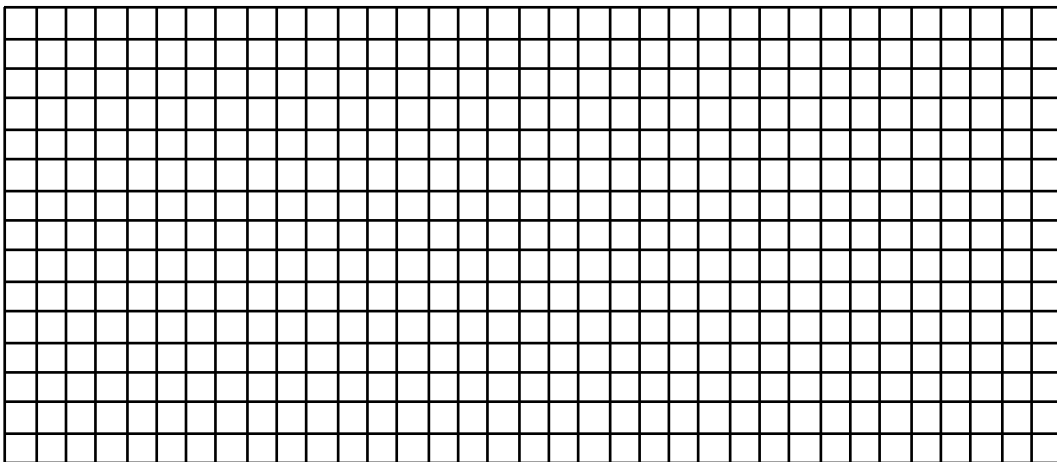

20766

Profile worksheet

Prompt	Function	Segment	Value
START1	Start Seg Prog 1		
END 1	End Seg Prog 1		
START2	Start Seg Prog 2		
END 2	End Seg Prog 2		
START3	Start Seg Prog 3		
END 3	End Seg Prog 3		
START4	Start Seg Prog 4		
END 4	End Seg Prog 4		
SOKDEV	Deviation Value		
RP UNIT	Ramp Units		
END ST	Program State at end		
SG1 RP	Ramp	1	
SG2 SP	Soak SP	2	
SG2 TI	Soak Time	2	
SG3 RP	Ramp	3	
SG4 SP	Soak SP	4	
SG4 TI	Soak Time	4	
SG5 RP	Ramp	5	
SG6 SP	Soak SP	6	
SG6 TI	Soak Time	6	
SG7 RP	Ramp	7	
SG8 SP	Soak SP	8	
SG8 TI	Soak Time	8	

Prompt	Function	Segment	Value
SG9 RP	Ramp	9	
SG10SP	Soak SP	10	
SG10TI	Soak Time	10	
SG11RP	Ramp	11	
SG12SP	Soak SP	12	
SG12TI	Soak Time	12	
SG13RP	Ramp	13	
SG14SP	Soak SP	14	
SG14TI	Soak Time	14	
SG15RP	Ramp	15	
SG16SP	Soak SP	16	
SG16TI	Soak Time	16	
SG17RP	Ramp	17	
SG18SP	Soak SP	18	
SG18TI	Soak Time	18	
SG19RP	Ramp	19	
SG20SP	Soak SP	20	
SG20TI	Soak Time	20	
SG21RP	Ramp	21	
SG22SP	Soak SP	22	
SG22TI	Soak Time	22	
SG23RP	Ramp	23	
SG24SP	Soak SP	24	
SG24TI	Soak Time	24	

C.4 Setpoint Program Prompt Hierarchy

Table C-1 lists all the function prompts for Setpoint Program data configuration in the order of their appearance. These prompts are available when SPPROG is enabled in the SPRAMP set up group described in Section 4.

All parameters may be changed while the program is disabled or in HOLD.

Table C-1 Prompt Hierarchy and Available Selections

Lower Display Prompt	Upper Display Range of Setting or Selection	Parameter Definition
SPPROG	DIS ENAB	SETPOINT PROGRAMMING —This must be set to ENAB for the setpoint program feature to work, and for the associated operating parameters to be displayed. SPRAMP must be disabled. (See Section 4.) DIS —Disabled ENAB —Enabled
START 1	1,3,5,7,9,11,13,15,17,19,21,23 [factory setting=1]	START SEGMENT FOR PROGRAM 1 —Enter the number of the first segment in Program 1.
END 1	2,4,6,8,10,12,14,16,18,20,22,24 [factory setting=6]	END SEGMENT FOR PROGRAM 1 —Enter the number of the last segment in Program 1.
START 2	1,3,5,7,9,11,13,15,17,19,21,23 [factory setting=7]	START SEGMENT FOR PROGRAM 2 —Enter the number of the first segment in Program 2.
END 2	2,4,6,8,10,12,14,16,18,20,22,24 [factory setting=12]	END SEGMENT FOR PROGRAM 2 —Enter the number of the last segment in Program 2.
START 3	1,3,5,7,9,11,13,15,17,19,21,23 [factory setting=13]	START SEGMENT FOR PROGRAM 3 —Enter the number of the first segment in Program 3.
END 3	2,4,6,8,10,12,14,16,18,20,22,24 [factory setting=18]	END SEGMENT FOR PROGRAM 3 —Enter the number of the last segment in Program 3.
START 4	1,3,5,7,9,11,13,15,17,19,21,23 [factory setting=19]	START SEGMENT FOR PROGRAM 4 —Enter the number of the first segment in Program 4.
END 4	2,4,6,8,10,12,14,16,18,20,22,24 [factory setting=24]	END SEGMENT FOR PROGRAM 4 —Enter the number of the last segment in Program 4.
RECYCL	0 to 99 [factory setting=0]	RECYCLES —Enter the number of times the program selected for execution will be repeated.
SOKDEV	–99.9 to 99.9 engineering units [factory setting=0.00]	SOAK DEVIATION —Enter the acceptable deviation from setpoint during a soak cycle. If the PV differs from the setpoint by more than the value of SOKDEV, soak time is frozen. There are no guaranteed soaks if SOKDEV = 0.

Lower Display Prompt	Upper Display Range of Setting or Selection	Parameter Definition
RPUNIT	TIME <i>[factory setting]</i> EU-M EU-H	<p>RAMP UNITS—The selection you make here will determine whether the ramp segments will be configured in terms of time or in terms of rate.</p> <p>TIME—Ramps will be configured in hrs:min.</p> <p>Engineering Units per Minute—Ramps will be configured as a rate in EU-M.</p> <p>Engineering Units per Hour—Ramps will be configured as a rate in EU-H.</p>
END ST	DIS <i>[factory setting]</i> HOLD	END STATE —Specify whether the program will be disabled after execution, or be placed in Hold.
SG1 RP	0 to 99 hours:0 to 59 min <i>(if RPUNIT = TIME)</i> or 0 to 999 degrees per minute or hour <i>(if RPUNIT = EU-M or EU-H)</i> <i>[factory setting=0.00]</i>	<p>SEGMENT 1 RAMP VALUE—Enter the ramp time or ramp value for Segment 1.</p> <p>Whether ramp segments are configured in terms of time or rate depends on whether RPUNIT is set to TIME or EU-M/EU-H.</p>
SG2 SP	range depends on setpoint limits <i>[factory setting=0]</i>	SEGMENT 2 SETPOINT —Enter the setpoint for Segment 2.
SG2 TI	0 to 99 hours:0 to 59 min <i>[factory setting=0]</i>	SEGMENT 2 TIME —Enter the duration for Segment 2
SG3 RP	0 to 99 hours:0 to 59 min <i>(if RPUNIT = TIME)</i> or 0 to 999 degrees per minute or hour <i>(if RPUNIT = EU-M or EU-H)</i> <i>[factory setting=0.00]</i>	SEGMENT 3 RAMP VALUE —Enter the ramp time or ramp value for Segment 3.
SG4 SP	range depends on setpoint limits <i>[factory setting 0]</i>	SEGMENT 4 SETPOINT —Enter the setpoint for Segment 4.
SG4 TI	0 to 99 hours:0 to 59 min <i>[factory setting=0]</i>	SEGMENT 4 TIME —Enter the duration for Segment 4

Lower Display Prompt	Upper Display Range of Setting or Selection	Parameter Definition
<p style="text-align: center;">.</p> <p style="text-align: center;">.</p> <p style="text-align: center;">.</p> <p>Continue to configure ramp segments (odd-numbered) and soak segments (even-numbered) through Segments 23 and 24.</p> <p style="text-align: center;">.</p> <p style="text-align: center;">.</p> <p style="text-align: center;">.</p>		
<p>SG23RP</p>	<p>0 to 99 hours:0 to 59 min <i>(if RPUNIT = TIME)</i></p> <p>or</p> <p>0 to 999 degrees per minute or hour <i>(if RPUNIT = EU-M or EU-H)</i> <i>[factory setting = 0.00]</i></p>	<p>SEGMENT 23 RAMP VALUE—Enter the ramp time or ramp value for Segment 23.</p>
<p>SG24SP</p>	<p>range depends on setpoint limits <i>[factory setting = 0]</i></p>	<p>SEGMENT 24 SETPOINT—Enter the setpoint for Segment 24.</p>
<p>SG24TI</p>	<p>0 to 99 hours:0 to 59 min <i>[factory setting = 0]</i></p>	<p>SEGMENT 24 TIME—Enter the duration for Segment 24</p>

C.5 Run/Monitor the Program

Introduction

Prior to running the program, make sure all the SPPROG prompts under the SPRAMP set up group have been configured with the required data. (See Table C-1.)

“HOLD” appears periodically in the lower display indicating that the program is in the HOLD state.









ATTENTION







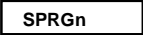



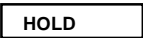

SP Programm parameters *cannot* be changed during RUN state (must be in HOLD state).





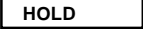

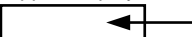

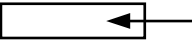

Run/Monitor functions

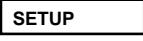
Table C-2 lists all the functions required to run and monitor the program.

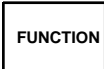
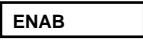
Table C-2 Run/Monitor Functions

Function	Press	Result
Set the Local Setpoint		You will see Upper Display  input value Lower Display  SP and local setpoint value. (If control set up group NumSPs = TWO, make sure the recorder is set to use setpoint 1 by checking that operating parameter UseSP1 is displayed. If UseSP2 is displayed, use σ or τ to switch to UseSP1.)
	 	To set the Local Setpoint value to where you want the program to start out.
Selecting the Program to be Run		until Lower Display 
	 	To select the program where n is the program number 1 through 4.

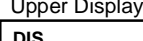
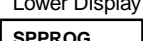
Function	Press	Result
Putting the Program in the Run State		until Lower Display 
	 	to toggle from "HOLD" to Lower Display  to indicate that the program is running.
Putting the Program in the Hold State		until Lower Display 
	 	to toggle from "RUN" to Lower Display  to hold the program at the current setpoint.
External Hold		If the recorder supports digital inputs, and REMSWn is set to HOLD, then when the contact n closes, the program will be placed in hold (if the setpoint program is running). The "hold" in the lower display will be displayed periodically in lower case. ATTENTION The keypad takes priority over the external switch for the RUN/HOLD function. Contact reopening runs the program.
External Run		If the recorder supports digital inputs, and REMSWn is set to RUN, then when the contact n closes, the program will be run (if the setpoint program is enabled). The "run n" in the lower display will be displayed periodically in lower case. ATTENTION The keypad takes priority over the external switch for the RUN/HOLD function. Contact reopening holds the program.
Viewing the Present Ramp or Soak Segment Number and Time	 until you see	Upper Display  ← input value Lower Display  ← XX HH . MM Time remaining in the SEGMENT in hours and minutes XX = 1 to 24

Function	Press	Result
Viewing the Number of Cycles Left for the Program	 until you see	Upper Display  input value Lower Display  REC.X Number of cycles remaining in the setpoint program X = 0 to 99
Ending the Program		When the final segment is completed, the "RUN" in the lower display either changes to "HOLD" (if configured for HOLD state), or disappears (if configured for disable of setpoint programming). The recorder will operate at the last setpoint achieved by the program.
Disable Program	 until you see	Upper Display  Lower Display 
	 until you see	Upper Display  Lower Display 
	 or  until you see	Upper Display  Lower Display 
	 until you see	Exit configuration and program is disabled.

D. Using Accutune II

D.1 Overview

Introduction

Accutune II provides foolproof, trouble-free on-demand tuning in the recorder. No knowledge of the process is required at start-up. The operator simply enters the desired setpoint and initiates the tuning. The recorder immediately starts controlling to the setpoint while it identifies the process, calculates the tuning constants and enters them into the tuning set up group, and begins PID control with the correct tuning parameters. This works with any process, including integrating type processes, and allows retuning at a fixed setpoint. The tuning sequence will cycle the recorder's output two full cycles between 0 % and 100 % (or low and high output limits) while allowing only a very small process variable change above and below the setpoint during each cycle.

- Accutune works for all control algorithms except ON/OFF.
- The recorder must be in Auto mode.
- Accutune works for integrating processes.

Enable/disable Accutune using the tuning set up group TUNE parameter described in Section 4.

Detailed instructions for using Accutune are provided in this appendix.

What's in this section?

This section contains the following information:

Topic	See Page
D.1 Overview	225
D.2 Starting and Stopping Tuning with Accutune II	226
D.3 Using Accutune with Duplex (Heat/Cool) Control	227



D.2 Starting and Stopping Tuning with Accutune II

Procedure

After "TUNE" has been enabled in the tuning set up group as described in Section 4, use the procedure in Table D-1 to start tuning.

To abort tuning in progress, press the MAN/AUTO/RESET key to take the recorder out of Auto mode. The message "AbRT" (abort) will be displayed as the value of tuning set up group parameter "AT ERR". The tuning parameters will retain the values they had at the start of the Accutune operation.

Table D-1 Procedure for Starting Accutune II

Step	Press	Action/Result	
1	<div style="border: 1px solid black; padding: 5px; display: inline-block; text-align: center;">DISP</div> until you see	Lower Display <div style="border: 1px solid black; padding: 2px; display: inline-block; text-align: center;">TuneOF</div>	If "TuneOF" (tune off) does not appear, then Accutune is not enabled.
2	 or 	to toggle to Lower Display <div style="border: 1px solid black; padding: 2px; display: inline-block; text-align: center;">TuneON</div>	Tuning will begin and the lower display will flash "TUNING". When tuning has been completed the lower display will again show "TuneOF".

D.3 Using Accutune with Duplex (Heat/Cool) Control

Introduction

“TUNE” can be done for applications using Duplex (Heat/Cool) control.









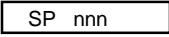

During tuning, Accutune II assumes SP 1 will cause a Heating demand, and then the calculated tuning parameters will be automatically entered as the first set of PID constants. Likewise, it assumes tuning at Local SP 2 will cause a Cooling demand, and the cooling parameters will be entered as the second set of PID constants.



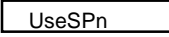

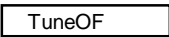

Procedure

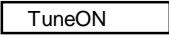
After “TUNE” has been enabled in the tuning set up group as described in Section 4, use the procedure in Table D-2 to start tuning. Note that control group parameter “NumSPs” must be set to “TWO” to enable the second setpoint.

To abort tuning in progress, press the MAN/AUTO/RESET key to take the recorder out of Auto mode. The message “AbRT” (abort) will be displayed as the value of tuning set up group parameter “AT ERR”. The tuning parameters will retain the values they had at the start of the Accutune operation.

Table D-2 Procedure for Using Accutune for Duplex Control

Step	Press	Action/Result
Heating Tuning		
1	 until you see	Lower Display  Display Setpoint 1.
2	 or 	Until the value of Setpoint 1 is at the desired value within the Heat zone. Make sure the recorder is in Auto mode. (“A” indicator lit.) If not, use the MAN/AUTO/RESET key to put the unit in Auto.
3	 until you see	Lower Display  This is the prompt used to select the setpoint. If it is not “USESP1”, use  or  to switch to “USESP1”.
4	 until you see	Lower Display  If “TuneOF” (tune off) does not appear, then Accutune is not enabled.
5	 or 	to toggle to Lower Display  Tuning will begin and the lower display will flash “TUNING”. The output will cycle between 50 % and 100 % (or high output limit). When tuning has been completed the lower display will again show “TuneOF”. The Heat tuning parameters are entered for the first set of PID constants in the tuning set up group.

Step	Press	Action/Result
Cooling Tuning		
6	<div style="border: 1px solid black; padding: 2px; display: inline-block; text-align: center;">DISP</div> until you see	Lower Display S2 nnn Display Setpoint 2.
7	 or 	Until the value of Setpoint 2 is at the desired value within the Cooling zone.
8	<div style="border: 1px solid black; padding: 2px; display: inline-block; text-align: center;">DISP</div> until you see	Lower Display UseSP1
9	 or 	to toggle to. Lower Display UseSP2
10	<div style="border: 1px solid black; padding: 2px; display: inline-block; text-align: center;">DISP</div> until you see	Lower Display TuneOF
11	 or 	to toggle to Lower Display TuneON Tuning will begin and the lower display will flash "TUNING". The output will cycle between 0 % and 50 % (or low output limit). When tuning has been completed the lower display will again show "TuneOF". The Cool tuning parameters are entered for the second set of PID constants in the tuning set up group.

E. Foreign Language Safety Instructions

SIKKERHESKRAV**DA2I-6055**

For at undgå elektrisk stød med mulighed for personskade, skal alle sikkerhedsbestemmelser i denne manual følges nøje.



Dette symbol advarer brugeren om en potentiel berøringsfare, såfremt der kan være adgang til den livsfarlige netspænding.



Beskyttende jordterminal. Terminalen er forberedt for og skal forbindes til beskyttelses-jordledning i henhold til stærkstrømsberkendtgørelsen (DK).

- Hvis udstyret ikke bruges som specificeret i manualen, kan den beskyttelse udstyret yder blive nedsat eller forsvinde.
- Eerstat kun komponenter som udtrykkeligt er specificeret som udskiftelige i manualen.
- Alle ledningsforbindelser skal følge stærkstrømsberkendtgørelsen (DK) og udføres af autoriseret erfarent personel.
- Den beskyttende jordterminal skal forbindes først af alle forbindelser (og fjernes som den sidste).
- Det anbefales jvf. stærkstrømsberkendtgørelsen, at der installeres en afbryder til frosyningspændingen nær udstyret.

UDSTYRS SPECIFIKATIONER

Strømforsyning	100 til 240 V - 20 til 27 Vac/dc
Frekvens	49 - 61 Hz
Nominel effekt	20 watts max.

OMGIVELSE SPECIFIKATIONER

Placer ikke udstyret i nærheden af brandbare væsker eller dampe.

Temperatur	Rumtemperatur : 0 til 55°C
Fugtighed	5 til 90% RH - 40°C
Vibration	0 til 200 Hz acceleration 0.5 g

UDSTYRS INSTALLATION

Skrivervaren skal monteres i en tavle for at forhindre adgang til bagterminaler.

VEILIGHEIDSVEREISTEN**DU2I-6055**

Ter vermindering van het gevaar van elektrische schokken die lichamelijk letsel kunnen veroorzaken, dient u alle veiligheidsaanwijzingen in dit document te volgen.



Dit symbool waarschuwt de gebruiker voor een potentieel schokgevaar wanneer toegang bestaat tot onderdelen die onder gevaarlijke spanning staan.



Beschermende aarde-aansluiting. Bestemd voor aansluiting van de aardingsdraad van de voeding.

- Indien de apparatuur wordt gebruikt anders dan door de fabrikant gespecificeerd, kan de bescherming, die de apparatuur biedt ongedaan worden gemaakt.
- Alleen die onderdelen mogen worden vervangen die door de fabrikant als uitwisselbaar zijn aangemerkt.
- Alle bedrading moet in overeenstemming zijn met de lokale elektriciteiseisen en moet aangelegd worden door geautoriseerd, ervaren personeel.
- De aardingsdraad moet worden aangesloten vóórdat alle andere bedrading wordt aangesloten (en als laatste worden verbroken).
- Het verdient aanbeveling een netschakelaar aan te brengen vlakbij het instrument.

APPARATUUR VOORWAARDEN

Voedingsspanning	100 tot 240 V - 20 to 27 Vac/dc
Frequentie	49 – 61 Hz
Vermogen of stroomvermogen	20 watts max.

OMGEVINGSCONDITIES

Gebruik het instrument niet in de aanwezigheid van ontvlambare vloeistoffen of dampen. Het gebruik van elk elektrisch instrument in een dergelijke omgeving vormt een gevaar voor uw veiligheid.

Temperatuur	In bedrijf : 0 tot 55°C
Vochtigheid	5 tot 90% RH - 40°C
Trilling	0 tot 200 Hz versnelling 0.5 g

MONTAGE VAN DE APPARATUUR

De recorder moet worden gemonteerd in een paneel om de toegankelijkheid tot de achterste aansluitpunten te beperken.

SIKKERHETSKRAV**NO2I-6055**

Følg alle retningslinjene i dette dokumentet, slik at du reduserer risikoen for elektrisk støt og mulige personskader.



Dette symbolet advarer brukeren om tilgjengelige terminaler med farlige spenninger og en potensiell fare for elektrisk støt.



Jordingsterminal. kablen for jording av systemet skal tilknyttes til denne terminalen.

- Dersom utstyret benyttes på en måte annerledes enn spesifisert av produsent, kan utstyrets beskyttelsesgrad forringes.
- Ingen komponenter eller deler skal skiftes ut dersom de ikke er uttrykkelig spesifisert som utskiftbare av din forhandler.
- Det er påkrevet med en hovedstrømsbryter i nærheten av utstyret.
- All kabling må utføres i henhold til gjeldende forskrifter og installeres av autoriser og erfaren installatør.
- Jord må tilknyttes før all annen kabling (og frakobles sist).

UTSTYRSPESIFIKASJONER

Strømtilførsel	100 til 240 V - 20 til 27 Vac/dc
Nettfrekvens	49 – 61 Hz
Kraftforbruk	20 watts max.

OMGIVELSER

Instrumentet må ikke opereres i nærheten av lettantennelige væsker eller gasser. Bruk av elektriske instrumenter i slike omgivelser utgjør en sikkerhetsrisiko.

Temperatur	omgivelse : 0 til 55°C
Fuktighet	5 til 90% HR - 40°C
Vibrasjon	0 til 200 Hz akselerasjon 0.5 g

UTSTYRSINSTALLASJON

Pass på å montere panelene på regulatoren, slik at berøring av terminalene på baksiden forhindres.

INSTRUÇÕES DE SEGURANÇA**PO2I-6055**

Para reduzir o risco de choque eléctrico que pode causar danos corporais, seguir todas as normas de segurança contidas nesta documentação.



Este símbolo avisa o utilizador sobre um eventual perigo de choque quando são acessíveis voltagens sob tensão perigosas.



Terminal de protecção de terra. Fornecido para ligação do condutor do sistema da protecção de terra.

- Se este equipamento for usado de modo não especificado pelo fabricante, a protecção fornecida pelo equipamento pode não ser adequada.
- Não se deve substituir qualquer componente (ou peça) que não seja explicitamente especificado como substituível pelo nosso revendedor.
- Toda a cablagem deve estar de acordo com os códigos eléctricos locais e deve ser realizada por pessoal experiente devidamente autorizado.
- O terminal de terra deve ser ligado antes de ser feita qualquer outra cablagem (e desligado em último lugar).
- Recomenda-se um comutador na fonte de alimentação principal próximo do equipamento.

ESPECIFICAÇÕES DO EQUIPAMENTO

Voltagem	100 a 240 V - 20 a 27 Vac/dc
Frequência	49 – 61 Hz
Potência ou consumo de corrente	20 Watts max.

CONDIÇÕES AMBIENTAIS

Não operar o instrumento na presença de líquidos ou vapores inflamáveis. A operação de qualquer instrumento eléctrico em tal ambiente constitui um perigo para a segurança.

Temperatura	Ambiente : 0 a 55°C
Humidade	5 a 90% RH a 40°C
Vibração	0 a 200 Hz aceleração 0.5 g

INSTALAÇÃO DO EQUIPAMENTO

O Registrador deve ser montado num painel para limitar o acesso do operador aos terminais traseiros.

NORMAS DE SEGURIDAD**SP2I-6055**

Para reducir el riesgo de choque eléctrico el cual podría causar lesiones personales, seguir todas las indicaciones de este documento.



Este símbolo previene al usuario de un riesgo potencial de descarga cuando se puede acceder a corrientes de tensión peligrosas.



Terminal de tierra de protección. Proporcionado para la conexión de la tierra de protección del conductor del sistema de alimentación.

- Si el equipo es utilizado de forma no especificada por el fabricante, la protección suministrada con el mismo podría resultar dañada.
- No reemplazar ningún componente (o parte) no explícitamente especificado por el suministrador.
- Todo el cableado debe realizarse de acuerdo con las normas eléctricas locales y debe ser realizado por personal experimentado.
- El terminal de tierra debe ser conectado antes que cualquier otro cable y desconectado el último.
- Se recomienda la instalación de un interruptor de la alimentación principal, cerca del equipo.

DATOS ELECTRICOS DEL EQUIPO

Tensión de alimentación	100 a 240 V - 20 a 27 Vac/dc
Frecuencia	49 – 61 Hz
Potencia o corriente	20 watts max.

CONDICIONES AMBIENTALES

No operar con el instrumento en presencia de líquidos o gases inflamables. La operación de cualquier equipo eléctrico en tal ambiente constituye un riesgo contra la seguridad.

Temperatura	Ambiente : 0 a 55°C
Humedad	5 a 90% RH a 40°C
Vibración	0 a 200 Hz aceleración 0.5 g

INSTALACION DEL EQUIPO

Este equipo debe ser montado en un panel para limitar al operador el acceso a los terminales traseros.

SÄKERHETSFÖRESKRIFTER**SW21-6055**

För att reducera riskerna av elektriska chocker som kan orsaka personskador, följ alla säkerhetsföreskrifter i denna dokumentation.



Denna symbol varnar användaren för risk för elchock vid tillfällig åtkomst av spänningsförande del.



Anslutning av skyddsjord. Avsedd för anslutning av elsystemets skyddsjordsledare.

- Om utrustningen används på ett sådant sätt, att det inte innefattas av tillverkarens specifikation, kan de inbyggda säkerhetsfunktionerna äventyras.
- Ersätt aldrig någon komponent (eller del) som inte är specificerad som ersättningsbar av tillverkaren.
- All ledningsdragnings måste utföras i enlighet med lokala bestämmelser och skall utföras av behörig personal med erfarenhet av sådant arbete.
- Skyddsjordsanslutningen skall anslutas före alla andra anslutningar (och losskopplas sist).
- En strömbrytare för näströmmen rekommenderas.

STRÖMFÖRSÖRJNING

Spänning	100 a 240 V - 20 a 27 Vac/dc
Frekvens	49 – 61 Hz
Effekt eller märkström	20 watts max.

OMGIVNINGSVILLKOR

Använd ej instrumentet i närhet av brännbara vätskor eller gaser. Användandet av instrumentet i sådant miljö är en direkt säkerhetsrisk.

Temperatur	Omgivande : 0 till 55°C
Fuktighet	5 till 90% RH - 40°C
Vibration	0 till 200 Hz acceleration 0.5 g

INSTALLATION

Instrumentet skall monteras i en panel eller i en låda för att undvika att personalen kommer i beröring med bakre inkopplingsplintar.

TURVALLISUUSMÄÄRÄYKSET**FI2I-6055**

Noudata tämän ohjeen kaikkia turvaohjeita välttääksesi sähkötapaturman vaaraa.



Tämä merkki varoittaa käyttäjää sähköiskun vaarasta paikassa, missä voi koskettaa vaarallisia jännitteitä.



Suojamaaliitin. Kytke maadoitsjohdin tähän liittimeen.

- Jos laitetta käytetään olosuhteissa, joihin sitä ei ole suunniteltu, käyttöturvallisuus voi heikentyä.
- Älä vaihda mitään komponenttia tai osaa, jota valmistaja ei ole määritellyt käyttäjän vaihdettavaksi.
- Asennus ja johdotus on tehtävä paikallisten varmuusmääräysten mukaisesti valtuutetun sähköasentajan toimesta.
- Ensimmäiseksi on kytkettävä suojamaa-liitin (ja viimeiseksi irroitettava).
- Laitteen läheisyyteen suositellaan asennettavaksi verkkokytkin.

LAITTEEN VAATIMUKSET

Syöttöjännite	100 - 240 V / 20 - 27 Vac/dc
Taajuus	49 - 61 Hz
Teho	20 watts

KÄYTTÖOLOSUHTEET

Älä käytä laitetta paikassa jossa on syttyviä nesteitä tai kaasuja, koska laitteen käyttö aiheuttaa räjähdysvaaran.

Lämpötila	ympäröivä : 0 ... 55°C
Kosteus	5 ... 90% RH - 40°C
Tärinä	0 ... 200 Hz Kiihtyvyys 0.5 g

LAITTEEN ASENNUS

Piirturi on asennettava paneeliin siten, että peräliitimille jää riittävästi tilaa.

CONSIGNES DE SECURITE**FR2I-6055**

Pour réduire tout risque de décharge électrique qui pourrait provoquer une lésion corporelle, respectez toutes les consignes de sécurité de cette documentation.



Ce symbole avertit l'utilisateur d'un risque électrique potentiel lorsqu'il peut avoir accès à des éléments sous tension.



Borne de mise à la terre. Destinée au raccordement du conducteur de mise à la terre de l'alimentation.

- Si l'équipement est utilisé dans un but non spécifié par le constructeur, la protection fournie avec cet équipement peut être affectée.
- Aucun composant (ou pièce) ne doit être remplacé s'il n'est pas explicitement spécifié comme tel par le constructeur.
- Tous les câblages doivent être conformes aux normes locales et doivent être réalisés par un personnel autorisé et expérimenté.
- La borne de masse doit être raccordée avant tout autre câblage (et débranchée en dernier).
- Il est obligatoire de connecter cet appareil sur une ligne possédant un moyen de coupure près de l'appareil.

CARACTERISTIQUES DE L'EQUIPEMENT

Tension d'alimentation	100 à 240 V ou 20 à 27 Vca/cc
Fréquence	49 – 61 Hz
Puissance ou courant	20 watts max.

CONDITIONS AMBIANTES

Ne jamais utiliser cet équipement en présence de liquides ou vapeurs inflammables.

L'utilisation de tout instrument électrique dans un tel environnement pourrait présenter un risque pour la sécurité.

Température	Ambiante : 0 à 55°C
Humidité	5 à 90 % HR à 40°C
Vibration	Fréquence : 0 à 200 Hz Accélération 0.5 g

INSTALLATION DE L'EQUIPEMENT

Cet appareil doit être monté dans un panneau pour limiter l'accès aux bornes arrières par l'opérateur.

SICHERHEITSHINWEISE**GE2I-6055**

Befolgen Sie alle Sicherheitshinweise in diesen Unterlagen, um das Risiko eines Stromschlags zu verringern, der zu Körperverletzung führen kann.



Dieses Symbol warnt den Benutzer vor eventueller Berührungsfahr, wo lebensgefährliche Spannungen zugänglich sein können.



Schützende Erdung. Für den Anschluß der schützenden Erdung der Versorgungssystemleitung.

- Bei Benutzung der Ausrüstungen auf nicht vom Hersteller angegebene Art und Weise kann der von der Ausrüstung gewährleistete Schutz beeinträchtigt werden.
- Ersetzen Sie keine Komponente (oder Teil), die/das nicht ausdrücklich vom Lieferanten als ersetzbar angegeben ist.
- Die gesamte Verkabelung muß den örtlichen Normen entsprechen und von zugelassenem, erfahrenem Personal durchgeführt werden.
- Die Erde muß vor allen anderen Kabeln angeschlossen (und zuletzt abgeklemmt) werden.
- In der Nähe der Ausrüstung muß ein Schalter in der Hauptstromversorgung vorhanden sein.

AUSRÜSTUNGSDATEN

Netzspannung	100 bis 240 V oder 20 bis 27 Vac/dc
Frequenz	49 - 61 Hz
Nennleistung	20 watts max.

UMGEBUNGSBEDINGUNGEN

Betreiben Sie das Gerät nicht in Gegenwart entflammbarer Flüssigkeiten oder Dämpfe. Der Betrieb elektrischer Geräte in solchen Umgebungen stellt ein Sicherheitsrisiko dar.

Temperatur	Umgebung : 0 bis 55°C
Feuchtigkeit	5 bis 90% RH - 40°C
Vibration	0 bis 200 Hz Beschleunigung 0.5 g

ANBRINGUNG DER AUSRÜSTUNGEN

Der Regler muß in ein Pult eingebaut sein, damit der Bediener nicht zu oft auf die hinteren Anschlüsse zugreifen muß.

ΑΠΑΙΤΗΣΕΙΣ ΑΣΦΑΛΕΙΑΣ**GR2I-6055**

Για να αποφύγετε τον κίνδυνο ηλεκτροπληξίας που μπορεί να προκαλέσει τραυματισμό ατόμων, ακολουθήστε όλες τις οδηγίες ασφαλείας του φυλλαδίου.



Αυτό το σύμβολο προειδοποιεί το χρήστη για μία δυνατότητα κινδύνου ηλεκτροπληξίας όταν μπορεί να υπάρχει πρόσβαση σε επικίνδυνες τάσεις.



Ακροδέκτης προστυτευτικής γείωσης. Προσφέρεται για σύνδεση με τη γείωση του καλωδίου τροφοδοσίας.

- Εάν ο εξοπλισμός χρησιμοποιείται κατά τρόπο που δεν περιγράφεται υπό τον κατασκευαστή, η προστασία που προσφέρεται από το προϊόν μπορεί να αλλοιωθεί.
- Μην αλλάζετε κανένα ανταλλακτικό (ή μέρος) που δεν αναφέρεται καθαρά ότι μπορεί να αντικατασταθεί από τον προμηθευτή μας.
- Όλες οι καλωδιώσεις πρέπει να είναι σύμφωνες με τις τοπικές προδιαγραφές και να γίνονται από ειδικευμένο έμπειρο προσωπικό.
- Η γείωση πρέπει να συνδεθεί πριν από οποιοδήποτε άλλο καλώδιο (και να αποσυνδέεται τελευταίο).
- Ένας διακόπτης στην κεντρική τροφοδοσία είναι απαραίτητος κοντά στον εξοπλισμό, εύκολης πρόσβασης για τον χειριστή.

ΧΑΡΑΚΤΗΡΙΣΤΙΚΑ ΕΞΟΠΛΙΣΜΟΥ

Τάση τροφοδοσίας	100 έως 240 V - 20 έως 27 V ac/dc
Συχνότητα	49 – 61 Hz
Ισχύς ρεύματος	20 watts max

ΣΥΝΘΗΚΕΣ ΠΕΡΙΒΑΛΛΟΝΤΟΣ

Μη βάζετε σε λειτουργία το όργανο σε παρουσία εύφλεκτων υγρών ή ατμών. Λειτουργία σε τέτοιο περιβάλλον είναι επικίνδυνο για την ασφαλεία.

Θερμοκρασία	Περιβάλλοντος : 0 έως 55°C
Υγρασία	5 έως 90 % RH ΜΗ ΣΥΜΠΥΚΝΩΜΕΝΗ / 40°C
Δονήσεις	0 - 200 Hz

ΕΓΚΑΤΑΣΤΑΣΗ ΕΞΟΠΛΙΣΜΟΥ

Ο ελεγχτής πρέπει να συναρμολογηθεί σε πίνακα για να περιορισθεί η πρόσβαση του χειριστή στους πίσω αχαιοδέχτες.

NORME DI SICUREZZA**IT21-6055**

Per ridurre i rischi di scariche elettriche che potrebbero causare alle persone, seguire tutte le precauzioni circa la sicurezza indicate in questa documentazione.



Questo simbolo avverte del pericolo di scossa elettrica nelle aree in cui sono accessibili conduttori sotto tensione.



Terminale di protezione verso terra. Previsto per il collegamento del conduttore di protezione verso terra del sistema di alimentazione.

- Se lo strumento viene utilizzato in modo diverso dalla specifica del costruttore, la protezione fornita dallo strumento può essere diversa.
- Non sostituire alcun componente (o parte) non specificato esplicitamente come ricambio dal vostro fornitore.
- Tutti i cablaggi devono essere in accordo con i regolamenti locali e devono essere eseguiti da personale esperto ed autorizzato.
- Il terminale di massa deve essere collegato prima di ogni altro filo (e scollegato per ultimo).
- E necessario che sia presente un interruttore nell'alimentazione principale accanto all'apparecchio.

ALIMENTAZIONE APPARECCHIATURA

Tensione di alimentazione Da 100 a 240 V ó da 20 a 27 Vac/dc

Frequenza 49 - 61 Hz

Potenza o corrente 20 watts max.

CONDIZIONI AMBIENTALI

Non far funzionare l'apparecchio in presenza di liquidi o gas infiammabili, in quanto questo potrebbe essere estremamente pericoloso.

Temperatura Ambiente : da 0 a 55°C

Umidità relativa Da 5 a 90% UR a 40°C

Vibrazioni Da 0 a 200 Hz
accelerazione 0.5 g

INSTALLAZIONE DELL'APPARECCHIO

Il apparecchio deve essere montato su un pannello per limitare l'accesso ai terminali posteriori.

F. Honeywell Service Centers

For application assistance, current specifications, pricing, or name of the nearest Authorized Distributor, contact one of the offices below.

ARGENTINA

Honeywell S.A.I.C.
Belgrano 1156
Buenos Aires
Argentina
Tel. : 54 1 383 9290

ASIA PACIFIC

Honeywell Asia
Pacific Inc.
Room 3213-3225
Sun Kung Kai Centre
N° 30 Harbour Road
Wanchai
Hong Kong
Tel. : 852 829 82 98

AUSTRALIA

Honeywell Limited
5 Thomas Holt Drive
North Ryde Sydney
Nsw Australia 2113
Tel. : 61 2 353 7000

AUSTRIA

Honeywell Austria
G.M.B.H.
Handelskai 388
A1020 Vienna
Austria
Tel. : 43 1 727 800

BELGIUM

Honeywell S.A.
3 Avenue De Bourget
B-1140 Brussels
Belgium
Tel. : 32 2 728 27 11

BRAZIL

HONEYWELL DO
Brazil
And Cia
Rua Jose Alves Da
Chunha
Lima 172
Butanta
05360.050 Sao Paulo
Sp
Brazil
Tel. : 55 11 819 3755

BULGARIA

HONEYWELL EOOD
14, Iskarsko Chausse
POB 79
BG- 1592 Sofia
BULGARIA
Tel : 359-791512/
794027/ 792198

CANADA

Honeywell Limited
The Honeywell Centre
300 Yorkland Blvd.
Toronto, Ontario
M2j 1s1
Canada
Tel.: 800 461 0013
Fax:: 416 502 5001

CZECH REPUBLIC

HONEYWELL, Spol.S.R.O.
Budejovicka 1
140 21 Prague 4
Czech Republic
Tel. : 42 2 6112 3434

DENMARK

HONEYWELL A/S
Automatikvej 1
DK 2860 Soeborg
DENMARK
Tel. : 45 39 55 56 58

FINLAND

HONEYWELL OY
Ruukintie 8
FIN-02320 ESPOO 32
FINLAND
Tel. : 358 0 3480101

FRANCE

HONEYWELL S.A.
Bâtiment « le Mercure »
Parc Technologique de St
Aubin
Route de l'Orme
(CD 128)
91190 SAINT-AUBIN
FRANCE
Tel. from France:
01 60 19 80 00
From other countries:
33 1 60 19 80 00

GERMANY

HONEYWELL AG
Kaiserleistrasse 39
D-63067 OFFENBACH
GERMANY
Tel. : 49 69 80 64444

HUNGARY

HONEYWELL Kft
Gogol u 13
H-1133 BUDAPEST
HUNGARY
Tel. : 36 1 451 43 00

ICELAND

HONEYWELL
Hataekni .hf
Armuli 26
PO Box 8336
128 reykjavik
Iceland
Tel : 354 588 5000

ITALY

HONEYWELL S.p.A.
Via P. Gobetti, 2/b
20063 Cernusco Sul
Naviglio
ITALY
Tel. : 39 02 92146 1

MEXICO

HONEYWELL S.A. DE
CV
AV. CONSTITUYENTES
900
COL. LOMAS ALTAS
11950 MEXICO CITY
MEXICO
Tel : 52 5 259 1966

THE NETHERLANDS

HONEYWELL BV
Laaderhoogweg 18
1101 EA AMSTERDAM
ZO
THE NETHERLANDS
Tel : 31 20 56 56 911

NORWAY

HONEYWELL A/S
Askerveien 61
PO Box 263
N-1371 ASKER
NORWAY
Tel. : 47 66 76 20 00

POLAND

HONEYWELL Sp.z.o.o
Ul Domaniewksa 41
02-672 WARSAW
POLAND
Tel. : 48 22 606 09 00

PORTUGAL

HONEYWELL
PORTUGAL LDA
Edificio Suecia II
Av. do Forte nr 3 - Piso 3
2795 CARNAXIDE
PORTUGAL
Tel. : 351 1 424 50 00

REPUBLIC OF IRELAND

HONEYWELL
Unit 1
Robinhood Business
Park
Robinhood Road
DUBLIN 22
Republic of Ireland
Tel. : 353 1 4565944

REPUBLIC OF SINGAPORE

HONEYWELL PTE LTD
BLOCK 750E CHAI
CHEE ROAD
06-01 CHAI CHEE IND.PARK
1646 SINGAPORE
REP. OF SINGAPORE
Tel. : 65 2490 100

REPUBLIC OF SOUTH AFRICA

HONEYWELL
Southern Africa
PO BOX 138
Milnerton 7435
REPUBLIC OF SOUTH
AFRICA
Tel. : 27 11 805 12 01

ROMANIA

HONEYWELL Office
Bucharest
147 Aurel Vlaicu Str.,
Sc.Z.,
Apt 61/62
R-72921 Bucharest
ROMANIA
Tel : 40-1 211 00 76/
211 79

RUSSIA

HONEYWELL INC
4 th Floor Administrative
Building of AO "Luzhniki"
Management
24 Luzhniki
119048 Moscow
RUSSIA
Tel : 7 095 796 98 00/01

SLOVAKIA

HONEYWELL Ltd
Mlynske nivy 73
PO Box 75
820 07 BRATISLAVA 27
SLOVAKIA
Tel. : 421 7 52 47 400/425

SPAIN

HONEYWELL S.A
Factory
Josefa Valcarcel, 24
28027 MADRID
SPAIN
Tel. : 34 91 31 3 61 00

SWEDEN

HONEYWELL A.B.
S-127 86 Skarholmen
STOCKHOLM
SWEDEN
Tel. : 46 8 775 55 00

SWITZERLAND

HONEYWELL A.G.
Hertistrasse 2
8304 WALLISELLEN
SWITZERLAND
Tel. : 41 1 831 02 71

TURKEY

HONEYWELL A.S.
Caryiyolu Sok No. 7
Ucgen Plaza, Kat 5-6-7
Icerenkoy 81120 Instanbul
Turkey
Tel (90-216) 575 66 00

UNITED KINGDOM

HONEYWELL
Honeywell House
Arlington Business Park
Bracknell,
Berkshire
RG12 1EB
Tel: +44 (0) 1344 656000

U.S.A.

HONEYWELL INC.
INDUSTRIAL PROCESS
CONTROLS
1100 VIRGINIA DRIVE
PA 19034-3260
FT. WASHINGTON
U.S.A.
Tel. : 1-800-343-0228

VENEZUELA

HONEYWELL CA
APARTADO 61314
1060 CARACAS
VENEZUELA
Tel. : 58 2 239 0211

Index

—2—

20 mA V parameter, 110

—4—

4mAVA parameter, 110

—A—

ACTION parameter, 97

ADDRES parameter, 111

AL HYS parameter, 107, 108

alarm hysteresis, 107, 108

alarm setpoints, 106, 113, 135

alarms

configuration, 106

troubleshooting, 186

alarms set up group, 106

aligning pens

with display, 188

without display, 169

AT ERR parameter, 101

automatic mode, 96, 133

AUX OUT parameter, 109

auxiliary output set up group, 109

—B—

BAUD parameter, 111

BIAS parameter, 87

BRNOUT parameter, 79, 81, 88, 175

burnout

with display, 81, 88

without display, 64

—C—

CAL IN parameter, 137, 151

CALERR error message, 177

calibration of inputs (with display), 141

calibration of outputs (with display), 153

calibration set up group, 151

calibration test (with display), 124, 174, 177

calibration values, 87

entering field values, 151

selecting factory or field, 136

troubleshooting, 177

CALTST, 124, 174, 175

CE conformity, 1, 23

CFGERR error message, 177

CFGTST, 124, 174, 177

chart

replacing, 158

chart high range value. *See* CHTHI parameter

chart low range value. *See* CHTLO parameter

chart parameters set up group, 90

chart plate

components, 66, 120

parts, 193

chart rotation troubleshooting

with display, 183

without display, 167

chart speed. *See* CHTSPD parameter

chart time

with display, 123

without display, 69

chart type. *See* CHTTYP parameter

CHTHI parameter, 89

CHTLO parameter, 89

CHTSPD parameter, 90

CHTTYP parameter, 90

Circuit breakers, 27

cleaning pen arm, 160

CNFTST, 175

COMM parameter, 111

communications

set up group, 111

troubleshooting, 187

Communications

specifications, 14

wiring, 35

compensated calibrator, 147

configuration

with display, 74, 83

without display, 45

configuration checksum test (with display), 124, 174, 177

configuration prompt hierarchy, 75

configuration record sheet, 117

configuration tips, 78

CONTRL parameter, 94, 124, 174

control algorithm. *See* CTRALG parameter

control hysteresis, 97

control set up group, 94

control setpoints, 94, 134

CTRALG parameter, 95, 100, 102, 103
 current outputs, 94
 calibration, 141, 154
 Current outputs, 41
 current range. *See* CURRNG parameter
 CURRNG parameter, 95
 CYC TI parameter, 103
 CYC2TI parameter, 103
 cycle timer. *See* CYC TI parameter

—D—

DBAND parameter, 97
 deadband. *See* DBAND parameter
 decimal point location. *See* DECMAL parameter
 DECMAL parameter, 85
 derivative term, 92, 96
 diagnostic tests
 with display, 124, 131, 173, 174
 without display, 166
 digital inputs
 configuration, 89, 93, 112, 113
 Dimensions, 15
 direct action control. *See* ACTION parameter
 display
 description, 72, 128
 testing, 125, 184
 display cable, 79
 door assembly parts, 192

—E—

EEFAIL error message, 177
 electrical noise, 162, 172
 Electrical noise precautions, 23, 28
 END 1 parameter, 218
 END ST parameter, 219
 error messages, 131, 176
 External switches, 33

—F—

factory calibration (with display), 141
 failsafe mode, 88, 98, 124, 133, 174, 175
 FAILSF error message, 177
 FAILSF parameter, 98, 124, 174
 field calibration (with display), 141
 FILTER parameter, 87
 FINL SP parameter, 104
 Flush mounting, 17
 Fuses, 27
 fuzzy overshoot suppression, 100
 FUZZY parameter, 101

—G—

GAIN 2 parameter, 103
 GAIN parameter, 98, 101, 102

—H—

heat/cool application, 101, 102, 103
 Heavy Duty door mounting, 18
 HOLD status message, 131, 176
 HOUR parameter, 90
 HYST parameter, 97
 hysteresis. *See* alarm hysteresis *and* control hysteresis

—I—

I MIN parameter, 99, 102
 I RPM parameter, 99, 102
 I2 MIN parameter, 103
 I2 RPM parameter, 103
 ice bath, 148
 IN PHI parameter, 87
 IN PLO parameter, 87
 IN TYP parameter, 86, 136, 177
 indicators on display, 72, 129
 ink cartridges
 part numbers, 193
 replacing, 159
 INP FL error message, 178
 INPRNG error message, 178
 input actuation type. *See* IN TYP parameter
 input bias
 with display, 87
 Input bias
 with display, 1
 input calibration (with display), 141
 input failure
 with display, 81, 88, 178
 input filter
 with display, 87
 Input filter, 1, 13
 input high range value. *See* INPHI parameter
 input out of range, 178
 input set up group, 85
 Input wiring
 analog, 31
 digital, 33
 INSPAN parameter, 152
 Installation, 11
 integral control. *See* I RPM parameter. *See* I MIN parameter
 integral term, 99
 INZERO parameter, 152

-
- J—**
- J6 connector, 79
- K—**
- Key error, 125
KEY ERROR, 125
 key functions, 73, 130
 keypad
 description, 72, 128
 testing, 125, 184
 Knockout locations, 16, 24
- L—**
- L DISP parameter, 105
 LD CAL parameter, 87, 136, 152
 LED indicators, 166
 with display, 176
 limit controller, 73
 configuration, 118, 137
 resetting, 139
 LIMIT parameter, 118
 load calibration values. *See* LD CAL parameter
 LOCK parameter, 78, 83, 114, 115, 151, 154
- M—**
- maintenance, 157
 MANRST parameter, 102
 manual mode, 96, 133
 manual reset. *See* MANRST parameter
 memory test (with display), 124, 174
 memory test (with display), 178
 MINRPM parameter, 99
 Modbus. *See* communications
 Model number breakdown, 4
 motor cable, 167, 183
 Mounting
 dimensions, 15
 flush, 17
 surface, 21
 Mounting methods
 2-inch pipe, 20
 Flush in panel, 17
 NEMA4 or Heavy Duty door, 18
 Panel or Wall Surface, 21
- N—**
- NEMA4 door mounting, 18
 NumSPs parameter, 94
- O—**
- Operating limits, 12
 operating parameters, 73, 130
 operation
 with display, 119, 128
 without display, 65
 operator interface, 72, 128
 limit control, 139
 OUT HI parameter, 97
 OUT LO parameter, 97
 OUTALG parameter, 94, 101, 103
 OUTLAG parameter, 95
 output calibration (with display), 141, 154
 output limits, 97
 output set up (with display), 74
 Output wiring
 current outputs, 41
 relays, 37
 outputs
 limit control, 139
 troubleshooting, 185
- P—**
- P3 connector, 167, 183
 Panel cutout, 15
 parts list, 191
 PB 2 parameter, 103
 PB parameter, 98, 101, 102
 PBorGN parameter, 98
 pen alignment set up group, 188
 pen group prompts, 89
 pen input. *See* PENIN parameter
 pen set up group, 89
 pen step test, 67
 pen trace troubleshooting
 with display, 182
 without display, 166
 PEN0 parameter, 188
 PENIN parameter, 81, 89, 123
 pens
 alignment
 with display, 188
 without display, 169
 maintenance, 160
 part numbers, 193
 replacing, 159
 troubleshooting
 with display, 184
 without display, 168
 PERIOD parameter, 105
 Pipe mounting, 20
 Plug locations, 16, 24
 Pn ERR error message, 124, 178
 power up controller mode recall. *See* PWR UP parameter
 power up state for limit control. *See* POWRUP parameter
 Power wiring, 28
 POWRUP parameter, 118
-

prompt hierarchy, 76
 proportional band. *See* PB parameter
 proportional control, 96, 100, 103
 PWR UP parameter, 96

—R—

raise switch. *See* SW3 raise switch
 RAMTST, 124, 174, 175
 range values for calibration, 142
 rate. *See* RATE T parameter
 RATE parameter, 92
 RATE T parameter, 102
 RATE2T parameter, 103
 real time values, 130
 recorder failure troubleshooting
 with display, 181
 without display, 165
 recorder part numbers, 194
 recording set up
 with display, 74
 without display, 45
 RECYCL parameter, 218
 reference accuracy, 199
 relays, 94, 107, 139, 185, 186
 Relays, 13, 37
 remote switch 1. *See* REMSW1 parameter
 remote switch 2. *See* REMSW2 parameter
 remote switch set up group, 112
 remote switches. *See* digital inputs
 REMSW1 parameter, 93, 113
 REMSW2 parameter, 113
 replacement parts, 191
 replacing ink cartridges, 159
 replacing the chart, 158
 RESET key, 118
 RESET parameter, 91
 reset switch SW2, 166, 178
 reverse acting control. *See* ACTION parameter
 RPUNIT parameter, 219
 RSTABL parameter, 93, 137
 RUN status message, 131, 176
 run switch. *See* SW5 run/setup switch

—S—

safety precautions, 45, 65, 66, 67, 79, 119, 120, 121,
 141, 161, 164, 169, 171, 180
 Safety precautions, 27
 scale factor. *See* SCALER parameter
 SCALER parameter, 92
 set up
 with display, 74
 without display, 45
 setpoint high limit. *See* SP HI parameter

setpoint high range limit. *See* SP HI parameter
 setpoint low limit. *See* SP LO parameter
 setpoint low range limit. *See* SP LO parameter. *See* SP LO
 parameter
 setpoint program, 104, 211
 status display, 73
 setpoint ramp group, 104
 setpoints. *See* control setpoints *and* alarm setpoints
 setup switch. *See* SW5 run/setup switch
 SG1 RP parameter, 219
 SG2 SP parameter, 219
 SG2 TI parameter, 219
 software version, 173
 SOKDEV parameter, 218
 SP HI parameter, 97, 118
 SP LO parameter, 97, 118
 SP PROG parameter, 104
 SP RAMP parameter, 104
 spare parts, 191
 Specifications, 12
 SPPROG parameter, 218
 square root of input, 86
 START 1 parameter, 218
 START parameter, 105
 startup
 with display, 119, 123, 126
 without display, 65, 69
 status set up group, 175
 step test
 with display, 121
 without display, 67
 Surface mounting, 21
 SW1 configuration switches
 with display, 79
 without display, 46, 49, 67
 SW2 reset switch, 166, 178
 SW3 raise switch, 169
 SW4 lower switch, 169
 SW5 run/setup switch, 67, 169
 SW6 burnout switch 5
 with display, 79, 81
 SW6 input switches
 with display, 79, 80
 without display, 46, 49
 switch settings
 with display, 79
 without display, 46, 49
 Switches
 external, 27

—T—

TB1 terminal, 165
 TB2 terminal, 31
 TB3 terminal, 38

- TB5 terminal, 153
temperature units. *See* UNITS parameter
TESTFL error message, 124, 174, 178
tests
 display and keypad, 125, 184
 pen step, 67
 self-diagnostic (with display), 124, 131, 174
 self-diagnostic (without display), 166
TIM IN parameter, 104
time index
 with display, 123
 without display, 69
timer
 configuration, 105
 display, 73, 105
 operation, 138
TIMER parameter, 105
TOTAL parameter, 91, 92
totalizer, 91
 configuration, 91
 resetting, 91, 137
totalizer set up group, 91
transmitter delay. *See* XmtDLY parameter
transmitter input characterization, 86
Transmitter wiring, 43
troubleshooting
 with display, 171
 without display, 161
TUNE parameter, 101
tuning set up group, 100
TUNING status message, 131, 176
- U—
- UNITS parameter, 85
- W—
- warnings, 65, 79, 119, 141, 161, 164, 171, 180
Warnings, 27, 28
Wire bundling, 26
wiring
 for calibration, 146, 153
 limit control, 139
Wiring
 analog inputs, 31
 communication, 35
 current outputs, 41
 digital inputs, 33
 insulation, 38, 41
 relay outputs, 37
 routing, 24
 transmitter power out, 43
- X—
- XMITTR parameter, 86
XmtDLY parameter, 111
XRSET parameter, 118