

Compact pressure switch for multiple actuators

GW...A5
GW...A5/1

DUNGS®
Combustion Controls

5.02



Technical description

The GW...A5 pressure switch is a compact pressure switch as per EN 1854 for DUNGS multiple actuators.

The pressure switches are suitable for switching a circuit on, off or over on changes in actual pressure relative to the set switching point (reference value).

The switching point can be set easily and quickly using a setting wheel provided with a scale without using a pressure gauge.

Application

Pressure switches for DUNGS multiple actuators GasMultiBloc and DMV double solenoid valve which can be either mounted directly on housing or by using an adapter.

Suitable for gases of families 1,2,3 and other neutral gaseous media.

Approvals

EC type test approval as per EC Gas Appliance Directive:

GW...A5 CE-0085 AO 3220

EC type test approval as per EC Pressure Equipment Directive:

GW...A5 CE0036

Pressure switch class "S" as per EN 1854.

Approvals in other important gas-consuming countries..

Functional description

Single-acting pressure switch in over-pressure range.

The pressure switches operate without any power supply.

Switching response

GW...A5

Short response time during pressure fluctuations.

GW...A5/1

Slow response time during short-term pressure fluctuations by additional damping nozzle.

Pressure Switch

The GW...A5 is a single-acting pressure switch acting in pressure range. The control unit responds to pressure.

If the set reference value is exceeded or undershot, the circuit is switched on, off or over.

Switching function

As pressure rises:

1 NC opens, 2 NO closes

As pressure falls:

1 NC closes, 2 NO opens

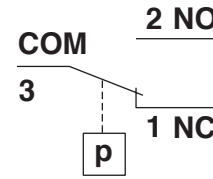

Specifications

Max. operating pressure	GW 3 A5 - GW 150 A5 GW 500 A5	500 mbar (50 kPa) 600 mbar (60 kPa)		
Pressure connection	O ring flange connection on underside of pressure switch			
Measuring connection	ø 9, length 10 mm, with screw plug			
Temperature range	Ambient temperature Medium temperature Storage temperature	-15 °C to +70 °C -15 °C to +70 °C -30 °C to +80 °C		
Materials	Housing: Switch: Diaphragms: Switching contact:	Aluminium die casting Polyamide NBR Ag		
Switching voltage	AC eff. min. 24 V DC min. 24 V	max. 250 V max. 48 V		
Nominal current	GW 10...500 A5 AC eff. max. 10 A	GW 3 A5 AC eff. max. 6 A		
Switching current	AC eff. max. 6 A AC eff. max. 3 A AC eff. DC DC	at cos φ 1 at cos φ 0,6 min. 20 mA min. 20 mA max. 1 A	AC eff. max. 4 A AC eff. max. 2 A AC eff. DC DC	at cos φ 1 at cos φ 0,6 min. 20 mA min. 20 mA max. 1 A
Electrical connection	Plug connection for line sockets as per DIN EN 175 301-803, 3-pin, protection insulated without ground connection			
Degree of protection	IP 54 as per IEC 529 (EN 60529)			
Setting tolerance	±15% switching point deviation referred to reference value, adjusted at pressure rises , vertical diaphragm position			

Installation position



Standard installation position; if different observe the change in switching point:

**GW 3...50 A5 max. ± 0,6 mbar
GW 150 A5 max. ± 1 mbar
GW 500 A5 max. ± 3 mbar**



In the horizontal installation position the switching pressure is increased.



When the pressure switch is mounted horizontally overhead, its switching pressure decreases.

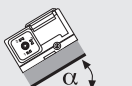

When the pressure switch is mounted in an intermediate position, its switching pressure deviates.

Designation

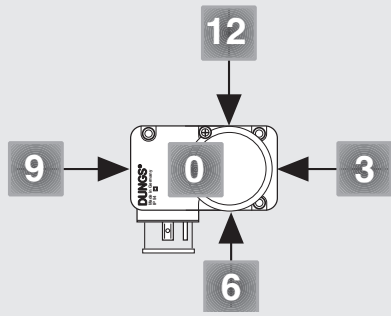

GW 150 A5 [Ag-G3-MS6-V12]

- **Pressure connection**
V12 Pressure connection G 1/4
Position 12
- **Test nipple**
MS6 Test nipple at position 6
- **Electrical connection**
G3 Equipment connector, 3 pol
protection-insulated, w/o grounding
- **Contact material**
Ag
- **Setting ranges [mbar]**
3 0,7 - 3
10 2 - 10
50 5 - 50
150 5 - 150
500 100 - 500
- **Pressure switch design**
GW A5 Pressure switch switches
when the setpoint is exceeded
or undershot.
GW A5/1 Pressure switch with damping
nozzle switches on if the set
reference value is exceeded
or undershot.

Order example

Pressure switch design

Pressure Switch GW...A5

Setting range

5 - 150 mbar

Contact material

Ag

Electrical connection

Equipment connector

Pressure connection

At position 12

Test nipple

MS 6

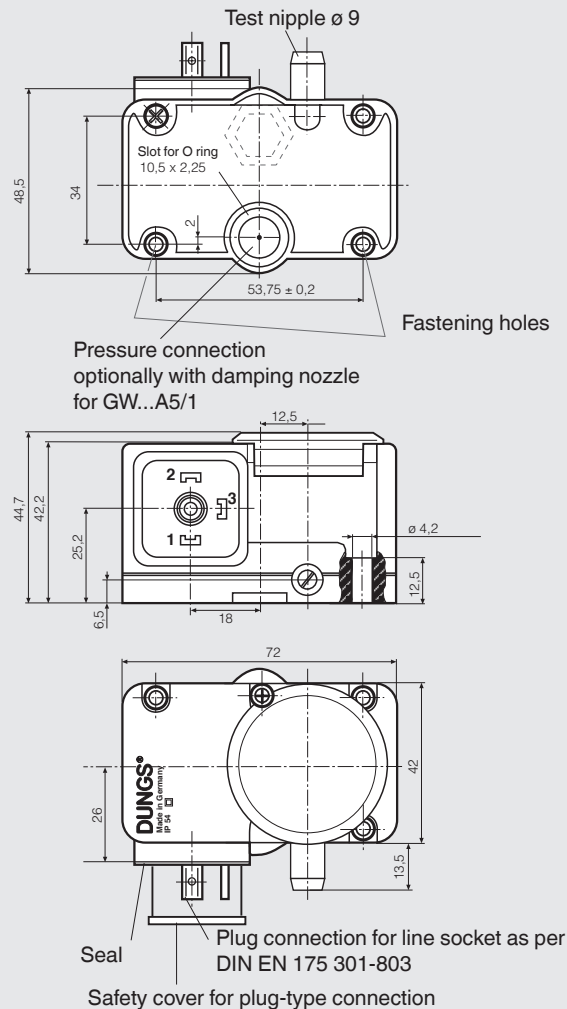

GW 150 A5 [Ag-G3-MS6-V12]

Dimensions [mm]



**Mounting options GW...A5
GasMultiBloc MB-...053/403**

**Pressure tap GW...A5
mounting possible ...**



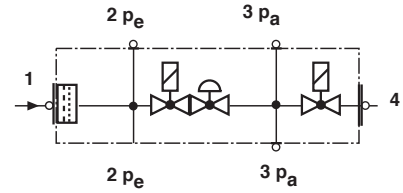
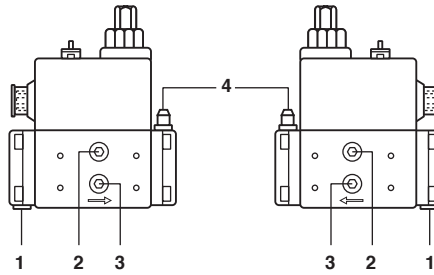

1	yes, with # 221630	
2	yes	
3	yes	
4	yes, with # 221630	



- 1,3 seal plug G 1/8
- 2 Instrument gland, optional
- 4 Instrument gland

**Mounting options GW...A5
GasMultiBloc MB-D..405 - 412;
MB-ZR.. 405 - 412**

**Pressure tap GW...A5
mounting possible ...**

1	alternative to 7	
2	no	
3	yes	
4	yes	
5	yes, with # 214 975	
6	yes, with # 221 630	
7	yes, (standard)	

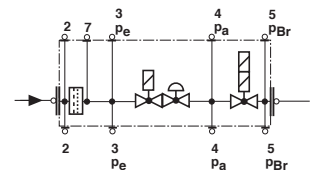
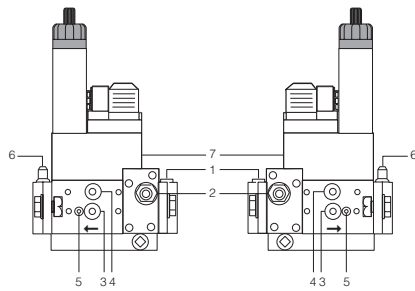
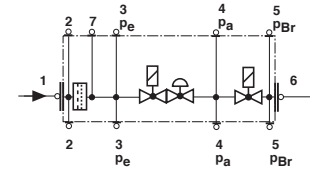
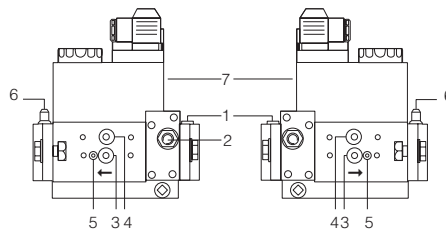

- 1,3,4 seal plug G 1/8
- 2,6 Instrument gland, optional G 1/8
- 5 M4 inner hex

**Anbaumöglichkeiten GW...A5
an Vorbaufilter für Dungs-
Mehrfachstellgerät**

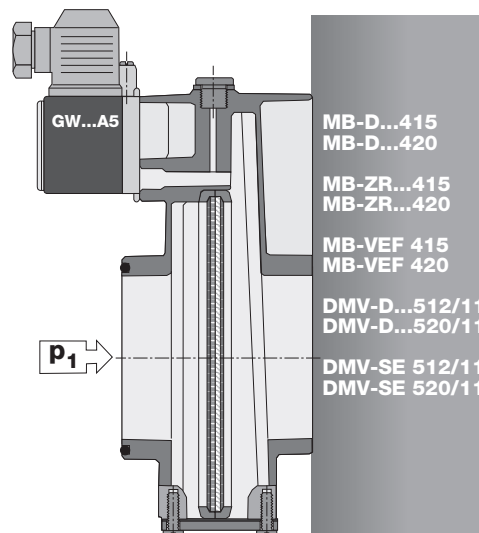

Druckabgriff nach Filtereinsatz



- MB-D...415
- MB-D...420
- MB-ZR...415
- MB-ZR...420
- MB-VEF 415
- MB-VEF 420
- DMV-D...512/11
- DMV-D...520/11
- DMV-SE 512/11
- DMV-SE 520/11

Mounting options GW...A5
Double solenoid valve DMV 503/11

Pressure tap GW...A5
mounting possible ...

1	yes	
2	yes	
3	yes, with # 214975	
4	yes (horizontal), with # 221 630 (vertical)	

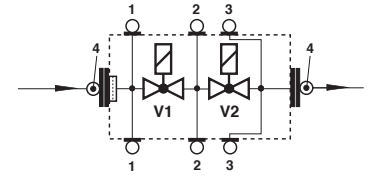
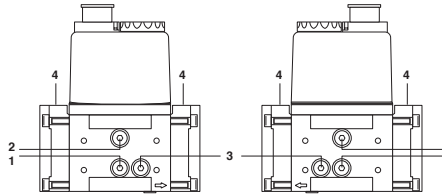

1,2,4
 G 1/8 seal plug as per
 DIN ISO 228
3
 Seal Plug as per M4

The seal plugs **1,2,4** can also be replaced by a G 1/8 instrument gland as per DIN ISO 228

Mounting options GW...A5
Double solenoid valve DMV 507-520/11
GasMultiBloc MB...415 - 420
MBC-300/700/1200

Pressure tap GW...A5
mounting possible ...

1	yes (GW _{min})	
2	yes (GW _{min})	
3	yes (GW _{VPS})	
4	yes	
5	yes	

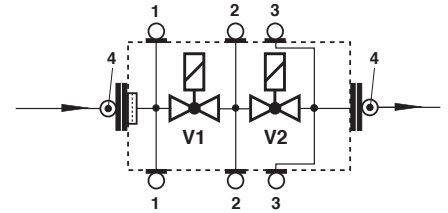
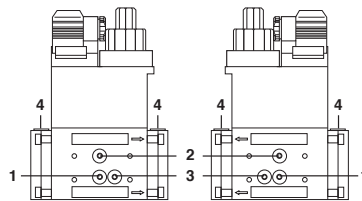





1,2,3,4
 G 1/8 seal plug as per
 DIN ISO 228

The seal plugs **1,2,3,4** can also be replaced by a G 1/8 instrument gland as per DIN ISO 228

Mounting options GW...A5
Double solenoid valve
DMV 525, DMV 5040/11-5125/11
DMV-1500-D, DMV...-65 - DMV...-125
MBC...-65 - MBC...-100 (pressure tap 4 no)

Pressure tap GW...A5
mounting possible ...

1	yes	
2	yes	
3	yes	
4	yes	
5	no	
6	no	

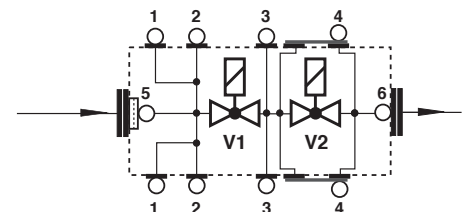
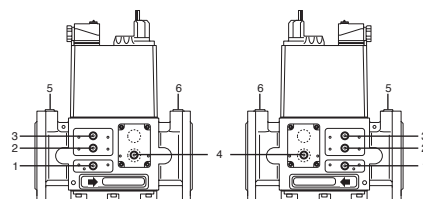

1,2,3,4
 G 1/8 seal plug as per
 DIN ISO 228
5,6
 G 1/4 DIN ISO 228

The seal plugs **1, 2,3,4** can also be replaced by a G 1/8 instrument gland as per DIN ISO 228

**Compact pressure switch
for multiple actuators**

**GW...A5
GW...A5/1**

DUNGS®
Combustion Controls

Brief technical data 1 mbar = 100 Pa = 0,1 kPa ≈ 10 mm WS

Type	Version [AG-G3-MS6-V12]	Order No.	Setting range [mbar]	Switching difference Δp [mbar]
GW...A5 pressure switch with mounting kit	GW 3 A5	229 250	0,7 - 3	$\leq 0,7$
	GW 10 A5	225 938	2 - 10	≤ 1
	GW 50 A5	225 939	5 - 50	$\leq 2,5$
	GW 150 A5	225 940	5 - 150	≤ 5
	GW 500 A5	227 639	100 - 500	≤ 15
Supplied in collective packaging				
GW...A5 pressure switch with damping ori- fice and mounting kit	GW 10 A5/1	241 245	2 - 10	≤ 1
	GW 50 A5/1	241 246	5 - 50	$\leq 2,5$
	GW 150 A5/1	241 247	5 - 150	≤ 5
	GW 500 A5/1	241 248	100 - 500	≤ 15
Supplied in collective packaging				

Accessories	Order-No.	for Type	Nominal diameters
Mounting kit (2 x M4x20,1 x O-ring)	223 280		
Adapter p_{Br}	214 975	MB-D ...405 - 420 MB-Z ...405 - 420 DMV- ...503 - 520	Rp 3/8 - Rp 2 Rp 3/8 - Rp 2 Rp 3/8 - Rp 2
Adapter on threaded flange (G 1/8)	221 630	MB- ...405-412 DMV- ... SV- ...505-520	Rp 3/8 - Rp 1 1/4 Rp 3/8 - Rp 2
Adapter kit for GW ... A5 with G 1/4 connection	222 982	DMV- ... MB- ...415-420	Rp 3/8 - Rp 2
Special adapter on request		MB- ... DMV- ... MVD- ...	DN 40 - DN 125 Rp 3/8 - DN 150
Line socket 3-pin + E grey GDMW	210 318		