

Eclipse Tube Firing Burners

Models TFB030, TFB075, TFB200

Version 2

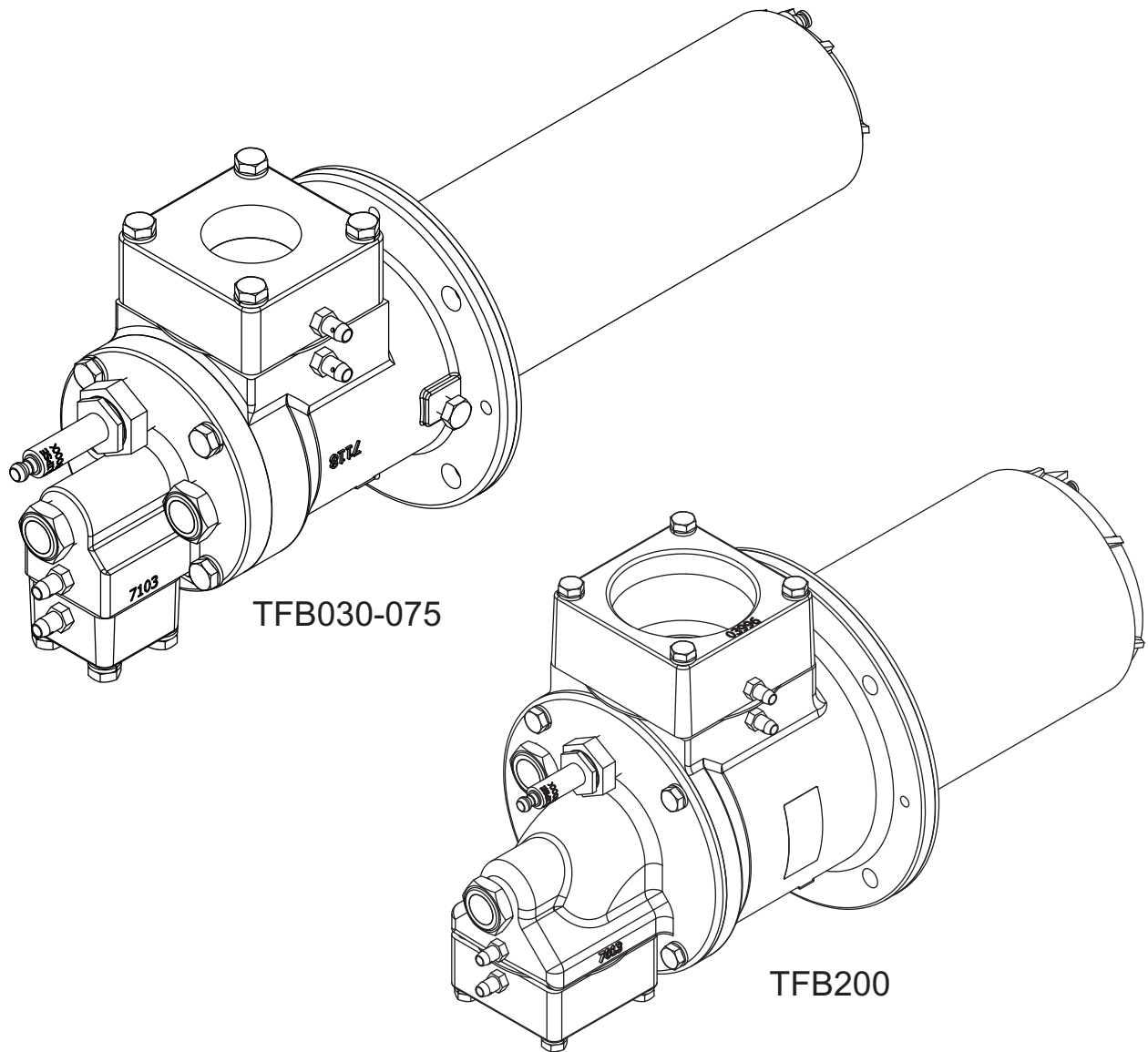

Copyright

Copyright 2007 by Eclipse, inc. All rights reserved worldwide. This publication is protected by federal regulation and shall not be copied, distributed, transmitted, transcribed or translated into any human or computer language, in any form or by any means, to any third parties, without the express written consent of Eclipse, inc.

Disclaimer Notice

In accordance with the manufacturer's policy of continual product improvement, the product presented in this brochure is subject to change without notice or obligation.

The material in this manual is believed adequate for the intended use of the product. If the product is used for purposes other than those specified herein, confirmation of validity and suitability must be obtained. Eclipse warrants that the product itself does not infringe upon any United States patents. No further warranty is expressed or implied.

Liability & Warranty

We have made every effort to make this manual as accurate and complete as possible. Should you find errors or omissions, please bring them to our attention so that we may correct them. In this way we hope to improve our product documentation for the benefit of our customers. Please send your corrections and comments to our Technical Documentation Specialist.

It must be understood that Eclipse's liability for its product, whether due to breach of warranty, negligence, strict liability, or otherwise is limited to the furnishing of replacement parts and Eclipse will not be liable for any other injury, loss, damage or expenses, whether direct or consequential, including but not limited to loss of use,

income, or damage to material arising in connection with the sale, installation, use of, inability to use, or the repair or replacement of Eclipse's products.

Any operation expressly prohibited in this manual, any adjustment, or assembly procedures not recommended or authorized in these instructions shall void the warranty.

Document Conventions

There are several special symbols in this document. You must know their meaning and importance.

The explanation of these symbols follows below. Please read it thoroughly.

How To Get Help

If you need help, contact your local Eclipse representative. You can also contact Eclipse at:

1665 Elmwood Rd.
Rockford, Illinois 61103 U.S.A.
Phone: 815-877-3031
Fax: 815-877-3336
<http://www.eclipsenet.com>

Please have the information on the product label available when contacting the factory so we may better serve you.

 ECLIPSE <small>Innovative Thermal Solutions</small>	www.eclipsenet.com
Product Name	
Item #	
S/N	
DD MMM YYYY	



This is the safety alert symbol. It is used to alert you to potential personal injunt hazards. Obey all safety messages that follow this symbol to avoid possible injury or death.



Indicates a hazardous situation which, if not avoided, will result in death or serious injury.



Indicates a hazardous situation which, if not avoided, could result in death or serious injury.



Indicates a hazardous situation which, if not avoided, could result in minor or moderate injury.

NOTICE

Is used to address practices not related to personal injury.

NOTE

Indicates an important part of text. Read thoroughly.



Table of Contents

1 Introduction	4
Product Description.....	4
Audience	4
TFB Documents	4
Purpose.....	4
2 Safety	5
Safety Warnings.....	5
Capabilities.....	5
Operator Training	5
Replacement Parts.....	5
3 System Design	6
Design.....	6
Step 1: Burner Selection	6
Step 2: Control Methodology	10
Step 3: Ignition System	11
Step 4: Flame Monitoring Control System	11
Step 5: Combustion Air System: Blower and Air Pressure Switch.....	12
Step 6: Main Gas Shut-Off Valve Train	13
Step 7: Process Temperature Control System	13
Appendix	i
Conversion Factors.....	i
System Schematics	iii
Notes	iv

Introduction

1

Product Description

The TFB is a nozzle-mixing burner designed for tube firing applications with multiple fuel capability. The burner consists of a housing, rear cover, air and fuel inlet blocks, spark rod, flame rod (if selected), UV scanner adapter (if selected), gas tube, nozzle and air shroud.

Burner design provides:

- Adjustable air shroud to maintain correct air velocity for different sized tube applications and fuels.
- Uniform tube temperatures for extending tube life.

Heat Exchanger

The TFB can be used with or without an exhaust leg recuperator. An exhaust leg recuperator is a heat exchanger that transfers heat from the exhaust air to the combustion air. Preheating the combustion air can increase the fuel efficiency by as much as 20%. The TFB can handle combustion air temperatures up to 1000°F. The recommended recuperators for the TFB are the Eclipse Bayonet (Data 317) and the Bayonet-Ultra (Spec. 318).

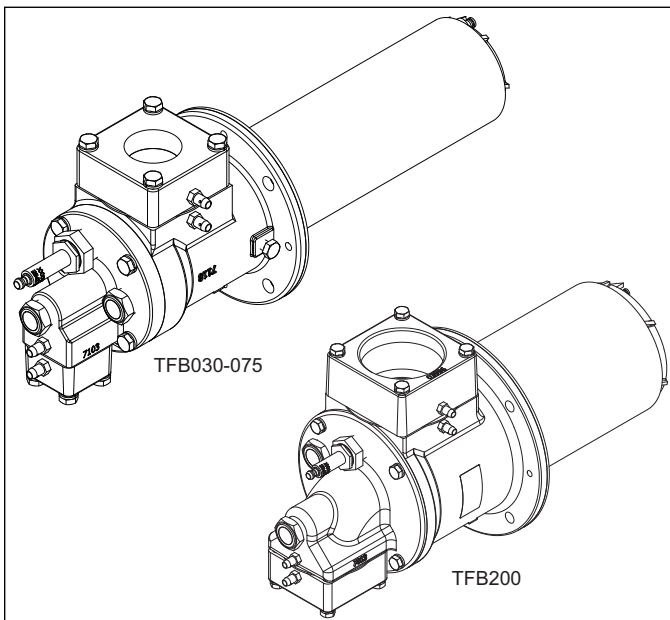

Figure 1.1. TFB Burner

Audience

This manual has been written for people who are already familiar with all aspects of a nozzle-mix burner and its add-on components, also referred to as “the burner system”.

These aspects are:

- Design
- Selection
- Use
- Maintenance

The audience is expected to have previous experience with this type of equipment.

TFB Documents

Design Guide No. 310

- This document

Datasheet, Series No. 310-1 through 310-3

- Available for individual TFB models
- Required to complete installation

Installation Guide No. 310

- Used with Datasheet to complete installation

Worksheet No. 310

- Required to provide application information to Eclipse Engineering

Related Documents

- EFE 825 (Combustion Engineering Guide)
- Eclipse Bulletins and Info Guides: 610, 710, 720, 730, 742, 744, 760, 930, I-354

Purpose

The purpose of this manual is to make sure that the design of a safe, effective, and trouble free combustion system is carried out.

Safety

Important notices which help provide safe burner operation will be found in this section. To avoid personal injury and damage to the property or facility, the following warnings must be observed. All involved personnel should read this entire manual carefully before attempting to start or operate this system. If any part of the information in this manual is not understood, contact Eclipse before continuing.

Safety Warnings



DANGER

- **The burners, described herein, are designed to mix fuel with air and burn the resulting mixture. All fuel burning devices are capable of producing fires and explosions if improperly applied, installed, adjusted, controlled or maintained.**
- **Do not bypass any safety feature; fire or explosion could result.**
- **Never try to light a burner if it shows signs of damage or malfunction.**



WARNING

- **The burner and duct sections are likely to have HOT surfaces. Always wear the appropriate protective equipment when approaching the burner.**
- **Eclipse products are designed to minimize the use of materials that contain crystalline silica. Examples of these chemicals are: respirable crystalline silica from bricks, cement or other masonry products and respirable refractory ceramic fibers from insulating blankets, boards, or gaskets. Despite these efforts, dust created by sanding, sawing, grinding, cutting and other construction activities could release crystalline silica. Crystalline silica is known to cause cancer, and health risks from the exposure to these chemicals vary depending on the frequency and length of exposure to these chemicals. To reduce the risk, limit exposure to these chemicals, work in a well-ventilated area and wear approved personal protective safety equipment for these chemicals.**

NOTICE

- **This manual provides information regarding the use of these burners for their specific design purpose. Do not deviate from any instructions or application limits described herein without written approval from Eclipse.**

Capabilities

Only qualified personnel, with sufficient mechanical aptitude and experience with combustion equipment, should adjust, maintain or troubleshoot any mechanical or electrical part of this system. Contact Eclipse for any needed commissioning assistance.

Operator Training

The best safety precaution is an alert and trained operator. Train new operators thoroughly and have them demonstrate an adequate understanding of the equipment and its operation. A regular retraining schedule should be administered to ensure operators maintain a high degree of proficiency. Contact Eclipse for any needed site-specific training.

Replacement Parts

Order replacement parts from Eclipse only. All Eclipse approved valves or switches should carry UL, FM, CSA, CGA and/or CE approval where applicable.

System Design

3

Design

Design Structure

Designing a burner system is a straight-forward exercise of combining steps that add up to a reliable and safe system. These steps are:

1. Burner Selection and Tube Design
2. Control Methodology
3. Ignition System
4. Flame Monitoring System
5. Combustion Air System: Blower & Air Pressure Switch
6. Main Gas Shut-Off Valve Train
7. Process Temperature Control System

Step 1: Burner Selection

The design of a combustion system for radiant tubes and immersion tubes is significantly different. For this reason, we have divided the process for burner selection into two separate sections:

- Step 1a: Radiant Tube Burner Application on page 6
- Step 1b: Immersion Tube Burner Application on page 8

All individual burner performance data including dimensions, capacities, operating parameters, and emissions information can be found in the following Datasheets:

- 310-1 Datasheet TFB030
- 310-2 Datasheet TFB075
- 310-3 Datasheet TFB200

Fuel Type

The usable fuel types are:

- Natural Gas
- Propane
- Butane

For other fuels, contact Eclipse with an accurate breakdown of the fuel contents.

Air Type

- Ambient
- Preheat

Step 1a: Radiant Tube Burner Application

Calculate the required heat release per tube.

Given the net heat requirement of the furnace (BTU/hr), divide by the number of radiant tubes to determine the required heat release per tube.

Calculate the tube surface area.

The burner radiates its heat to the process through the wall of the tube. To calculate the required burner input you must know the total area of the tube inside the furnace.

To calculate the tube surface area, use this formula:

$$\text{Tube Surface Area} = OD \times \pi \times n \times L$$

- OD = the outside diameter of the tube in inches
- $\pi = 3.142$
- n = number of tube legs
 - 2 for a U-Tube
 - 3 for a trident tube
 - 4 for a W-tube
- L = the total length of each leg in inches

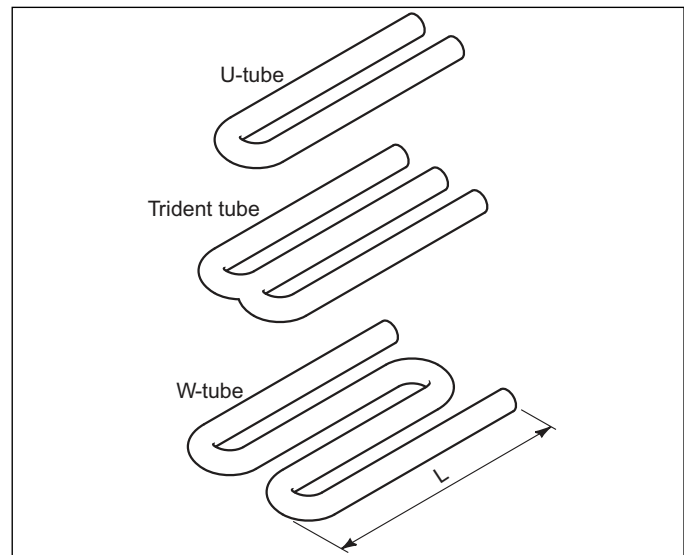

Figure 3.1.

Determine the Maximum Heat Transfer Rate

The maximum heat transfer rate is the maximum amount of heat that the tube can radiate to the process per time unit.

The maximum heat transfer rate of a tube depends on the temperature of the chamber and how the tube is mounted inside the furnace or not enclosed.

An enclosed tube has a lower maximum heat transfer rate than a tube which is free to radiate in all directions.

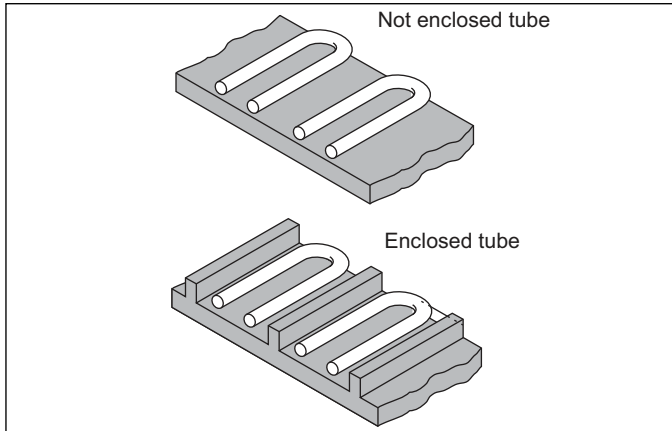

Figure 3.2.

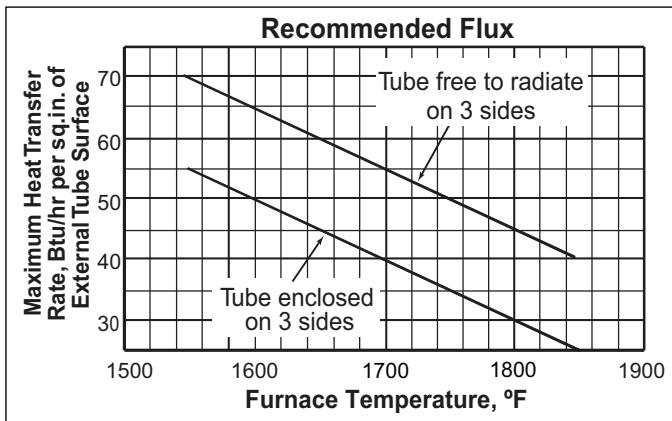

Figure 3.3.

Calculate the Maximum Heat Release

Multiply the previously calculated tube surface area by the maximum heat transfer rate:

$$\text{Maximum heat release} = \text{tube surface area} \times \text{maximum heat transfer rate}$$

Compare the heat releases

Compare the required heat release with the maximum heat release.

If the required heat release is greater than the maximum heat release, then the number or the size of the radiant tubes must be increased.



- Exceeding the maximum heat release will significantly shorten the tube life.

Determine Efficiency

Decide whether or not you want to use a recuperator. A recuperator is a heat exchanger which uses heat from the exhaust to pre-heat the combustion air. The effect of a recuperator on the efficiency of the system can be significant, as shown in the table below.

Furnace Chamber Temperature	Without Recuperator (Ambient Air)	With Recuperator (Preheated Air)
1000°F (538°C)	57%	71%
1300°F (704°C)	51%	68%
1550°F (843°C)	47%	65%
1650°F (899°C)	44%	64%
1750°F (954°C)	41%	63%
1850°F (1010°C)	39%	62%

*Actual efficiency will vary depending on gas type, recuperator, excess air, piping losses, etc.

Calculate the Gross Burner Input

Calculate the gross burner input (BTU/hr) with this formula:

$$\text{Gross Burner Input} = \text{Required Heat Release} / \text{Efficiency}$$

Compare the Gross Burner Input

Compare the gross burner input with the maximum tube input. If the gross burner input is greater than the maximum tube input from the table, below, then the size of the radiant tube must be increased.

Tube ID (inches)	Maximum Input (1000 BTU/hr)
4	300
5	600
6	900
8	1500
10	2500
12	3500

Exceeding these inputs may result in burner pulsation or other operational problems.

Sizing Example

Application parameter

- 4 U-tube - 4.5" OD x 75" effective length
- 500,000 BTU/hr total required heat release - recuperated
- 1650°F chamber temperature
- open radiate angles (not enclosed tubes)

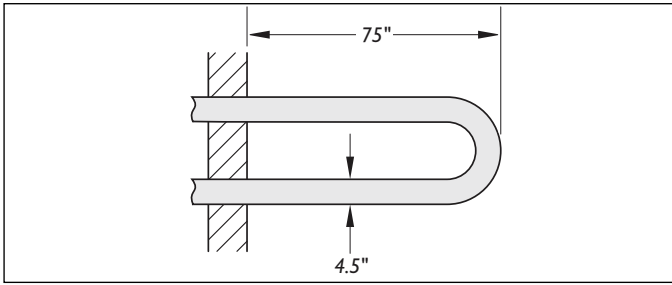

Figure 3.4.

1. The required heat release per tube:

$$\frac{\text{total required heat release}}{\text{number of tubes}} = \text{Required heat release per tube}$$

$$500,000 / 4 = 125,000 \text{ BTU/hr}$$

2. Tube surface area for each tube:

$$OD \times \pi \times n \times L = \text{Tube Surface Area}$$

$$4.5 \times 3.142 \times 2 \times 75 = 2120.85 \text{ in}^2$$

(n = 2 because it is a U-tube which has two legs)

3. From chart "Maximum Heat Transfer Rate", find the maximum heat transfer rate:

- 60 BTU/in²/hr

4. The maximum permissible heat release (per tube) is:

$$\text{tube surface area} \times \text{maximum heat transfer rate} = \text{Maximum heat release}$$

$$2120.85 \times 60 = 127,251 \text{ BTU/hr}$$

5. This is sufficient, because only 125,000 BTU/hr is required.

6. From Table 3.1 "Efficiency", find the efficiency with a recuperator at 1650°F:

- 64%

7. The gross burner input (per tube) is:

$$\frac{\text{required heat release}}{\text{efficiency}} \times 100 = \text{Gross burner input}$$

$$(125,000 / 64) \times 100 = 195,312 \text{ BTU/hr}$$

Size the system for 200,000 BTU/hr per burner.

8. Compare the result from step 7 to the required maximum inputs in Table 3.2. Gross input is less than 300,000 BTU/hr, therefore, the 4" w.c. tube can be used.

Air Tube Length

The air tube length varies based on the location of the hot face of the furnace relative to the mounting flange of the burner.

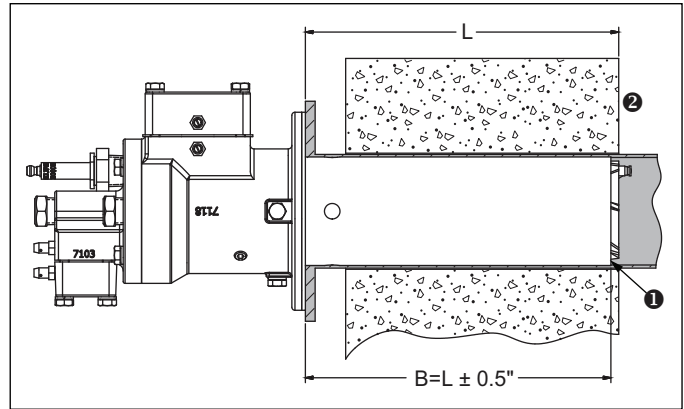

Figure 3.5. Air Tube Length

The end of the air tube ❶ must be within ± 0.5" of the face of the furnace wall ❷.

You choose the length closest to your requirements. You can find the air tube lengths (dimension B) that are available in the appropriate Datasheet 310-1 (TFB030), 310-2 (TFB075), or 310-3 (TFB200).

Step 1b: Immersion Tube Burner Application

Determine the net heat release required to the tank

The net heat release to the tank is derived from heat balance calculations. These calculations are based on the heat-up and steady-state requirements of the process, and take into account surface losses, tank wall losses and tank heat storage. Detailed guidelines for heat balance calculations are in the Eclipse Combustion Engineering Guide (EFE 825).

Determine the efficiency

The efficiency of the tube is directly linked to the effective tube length. The diameter of the tube has no influence on the efficiency. The efficiency of the tube is the factor between the burner input to the tube and net output to the tank. At a given burner input, the net output to the tank is higher for a longer tube than for a relatively short tube.

NOTE: A commonly used efficiency is 70%. Efficiencies greater than 85% will produce condensation in the tube which may shorten tube life or disrupt the system.

Figure 3.6 below shows the relationship between the tube length and the efficiency.

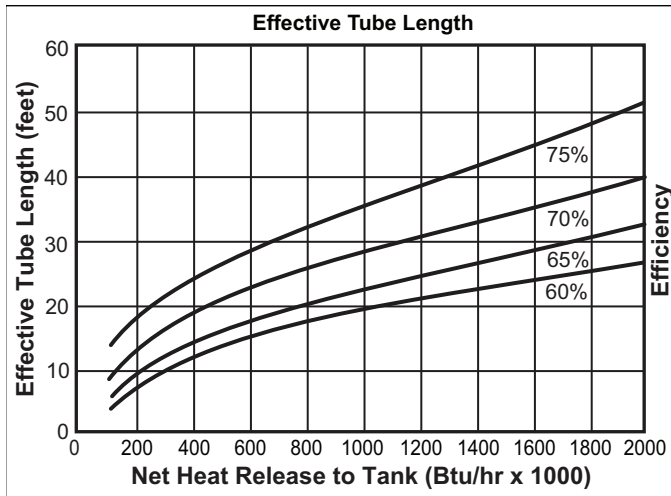

Figure 3.6.

The effective tube length required is a function of the efficiency chosen. The effective length of a tube is the total length of straight tube covered by liquid. Add 13" for each 90° bend.

Calculate the gross burner input

Calculate the gross burner input in (BTU/hr) with this formula:

$$\frac{\text{net heat release to the tank}}{\text{tube efficiency}} = \text{gross burner input}$$

Compare the gross burner input

Compare the gross burner input with the maximum tube input. If the gross burner input is greater than the maximum tube input from the table below, then the size of the immersion tube must be increased.

Table 3.3 Maximum Tube Input	
Tube ID (inches)	Maximum Input (1000 BTU/hr)
4	300
5	600
6	900
8	1500
10	2500
12	3500

Exceeding these inputs may result in burner pulsation or other operational problems.

Sizing Example

Application parameters

- Net heat release required to tank: 1,000,000 BTU/hr
- Efficiency: 70%
- Effective tube length: (Figure 3.6) 37'
- Gross Burner Input: $1,000,000 / .70 = 1,428,571$ BTU/hr
- 200TFB Burner: 2,000,000 BTU/hr maximum capacity
- Minimum Tube I.D. : (Table 3.3) = 8"

- Tube Surface Area/sq. in. = O.D. x π x L
 O.D. = 8.625
 $\pi = 3.142$
 L = Total effective tube length in inches = $(37 \times 12) = 444"$
 $8.625 \times 3.142 \times 44 = 12,032.3$ sq. in.
- BTU/hr/sq.in = Net heat release to tank / sq.in. surface area
 $1,000,000 / 12,032.3 = 83.1$ BTU/sq.in./hr

NOTE: If the medium to be heated in the above example was cooking oil, it would be necessary to increase tube length or select a larger tube. It is recommended that you not exceed 50 BTU/hr/sq.in. for cooking oil.

Air Tube Length

The air tube length should be as short as possible to maximize the exposure of the immersion tube to the flame.



- Any section of immersion tube that extends beyond the nozzle, must be submerged in the liquid. Dimension B must be greater than Dimension A.

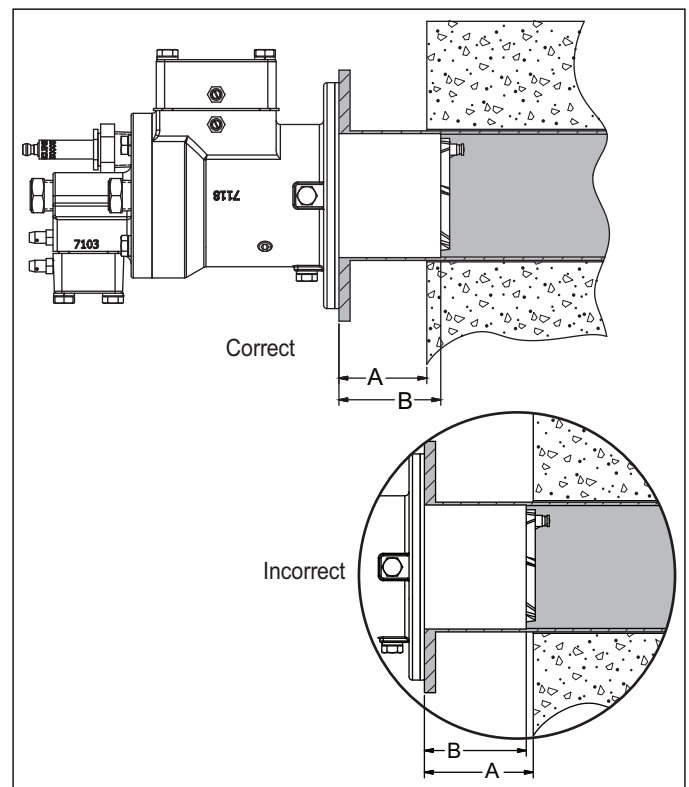

Figure 3.7. Air Tube Length

Choose the shortest tube length (Dimension B) that is greater than Dimension A. You can find the air tube lengths (dim. B) that are available in the appropriate 310 Datasheet series.

Tube Design

1. Elbows

- We recommend the use of standard and sweep elbows only.
- The first elbow should be at least eight tube diameters from the face of the burner.

2. Stack

- Make sure that the stack is large enough to handle the exhaust flow plus the dilution air.
- The stack must be at least one pipe size larger than the tube exhaust.

NOTE: Detailed guidelines for flue sizing calculations are in the Eclipse Combustion Engineering Guide (EFE 825).

3. Draft breaking hood

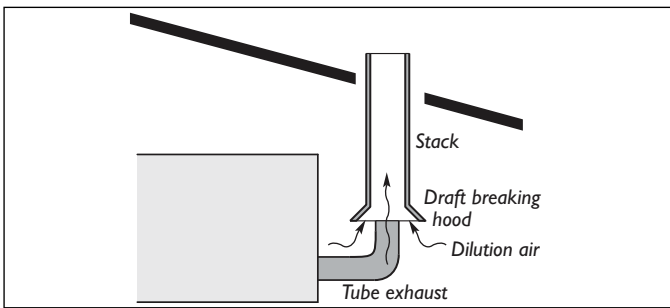

Figure 3.8.

A draft breaking hood is an open connection between the heater tube exhaust and the exhaust stack. It allows fresh dilution air to pass into the exhaust and mix with the exhaust gases.

The advantages of a draft hood are:

- the burner operation is less sensitive to atmospheric conditions
- the temperature of the exhaust gases is lower when they pass through the roof.

NOTE: Make sure that it is possible to get access between the draft hood and the tube exhaust. Then you can install a damper plate if acoustic feedback occurs in the tube.

Step 2: Control Methodology

The control methodology is the basis for the rest of the design process. Once you know what your system will look like, you can select the individual components. Which control methodology you choose depends on the type of process that you want to control.

Control Methods

There are two main methods to control the input of a TFB system:

1. Modulating control

A burner system with modulating control gives an input that is in proportion with the demands of the process. Any input between high and low fire is possible. The burner operates at 15% excess air at high fire, and 100% excess air (min.) at low fire.

2. High/low control

A system with high/low control gives a high or low fire input to the process. No input between high and low fire is possible. The burner operates at 15% excess air at high fire, and 100% excess air (min.) at low fire.

The only difference in the components is the type of actuator on the automatic butterfly valve (control valve ❶, page 11).

On the next page you will find schematics of these control methods. The symbols in the schematics are explained in the Appendix on page ii.

Automatic gas shut-off by burner (optional)

As an option, an automatic gas shut-off valve can be installed. If the flame monitoring system detects a failure, the gas shutoff valve closes, interrupting the gas supply to the burner that caused the failure.

System schematics

1. Air

The control valve ❶ is in the air line. It sets the air flow to the required value.

2. Gas

The ratio regulator ❷ allows the required amount of gas to go to the burner. Low fire gas is limited by ratio regulator ❷. High fire gas is limited by the manual butterfly valve ❸.

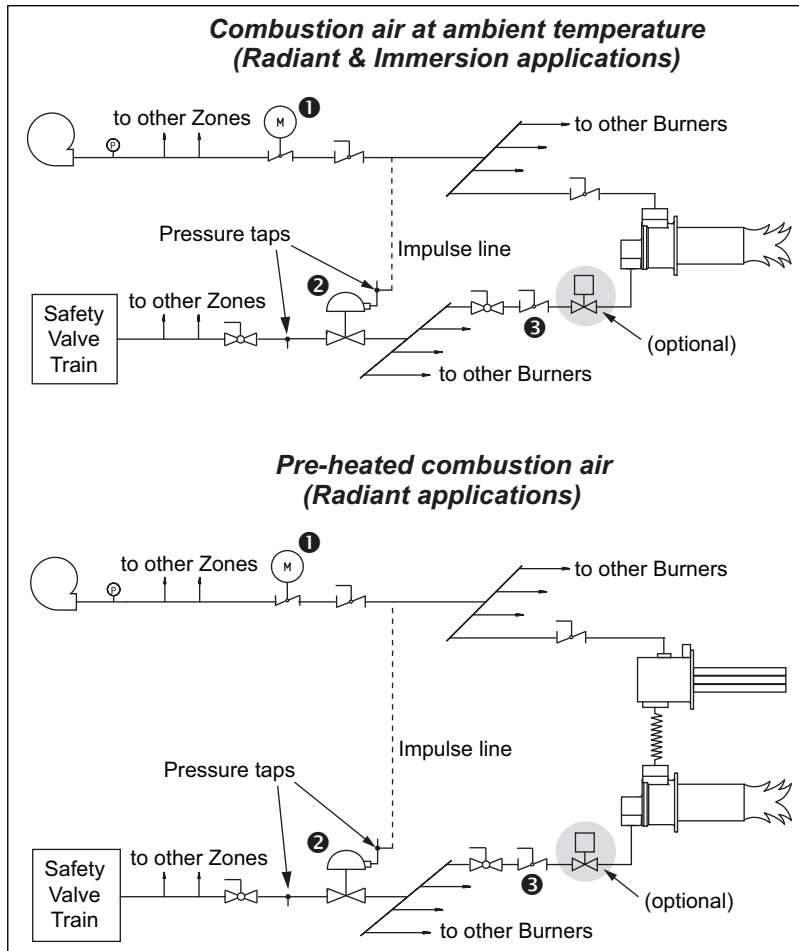

Figure 3.9. System Schematics

Step 3: Ignition System

For the ignition system use:

- 6000 VAC transformers
- full wave spark transformers
- one transformer per burner

Do NOT use:

- 10,000 VAC transformers
- twin outlet transformers
- distributor type transformers
- half wave spark transformers

TFB burners are capable of direct spark ignition anywhere within the listed operating range. However, it is recommended that low fire start be used. Local safety and insurance requirements demand that you limit the maximum time that a burner takes to ignite. These time limits vary from country to country. For the USA the time limit is 15 seconds, for Europe it is 3 seconds.

The time that a burner takes to ignite depends on:

- the distance between the gas shut-off valve and the burner
- the air/gas ratio
- the gas flow at start conditions

In the USA, with a time of 15 seconds to ignition, there should be sufficient time to ignite the burners. It is possible, however, to have the low fire too low to ignite within the time limit. Under these circumstances you must consider the following options:

- start at higher input levels
- resize and/or relocate the gas controls

Step 4: Flame Monitoring Control System

A flame monitoring system consists of two main parts:

- a flame sensor
- flame monitoring control

NOTE: A flame monitoring system may not be required for tube fired burners. According to NFPA 86, combustion safeguards on radiant tube type heating systems are not required where a means of ignition is provided and the systems are arranged and designed such that either of the following conditions is satisfied:

- The tubes are of metal construction and open at one or both ends with heat recovery systems, if used, that are of explosion-resistant construction.
- The entire radiant tube heating system, including any associated heat recovery system, is of explosion-resistant construction.

It is recommended to check your local standards to verify.

Flame Sensor

Flame sensing is by flame rod (TFB030 & TFB075) or UV scanner (all models).

The UV scanner must be compatible to the flame monitoring control that is used. Refer to the manual of your selected control for proper selection of the scanner.



- **If combustion air is preheated, the UV scanner must be protected from high temperatures. Install the UV scanner with a heat block seal and supply cooling air. See Bulletin 834.**

Flame Monitoring Control

The flame monitoring control processes the signal from the flame sensor and controls the start-up and shut-down sequences.

Eclipse recommends the following flame monitoring controls:

- Trilogly series T600 (Instruction Manual 835)
- Veri-Flame series 5600 (Instruction Manual 818)
- Bi-Flame series 6500 (Instruction Manual 826)
- Multi-Flame series 6000 (Instruction Manual 820)

If other controls are considered, contact Eclipse to determine how burner performance may be affected. Flame monitoring controls that have lower sensitivity flame detecting circuits may limit burner turndown and change the requirements for ignition.

Flame monitoring controls that stop the spark as soon as a signal is detected may prevent establishment of flame, particularly when using UV scanners. The flame monitoring control must maintain the spark for a fixed time interval that is long enough for ignition.

Step 5: Combustion Air System: Blower and Air Pressure Switch

The effects of atmospheric conditions

Blower data is based on the International Standard Atmosphere (ISA) at Mean Sea Level (MSL), which means that it is valid for:

- sea level
- 29.92" Hg
- 70°F.

If you are above sea level or in a hot area, the properties of the air are different. As the density of the air decreases, the outlet pressure and the flow of the blower decreases.

An accurate description of these effects is in the Eclipse Combustion Engineering Guide (EFE 825). The Guide contains tables for the effect of pressure, altitude and temperature on air.

Blower

The rating of the blower must match the system requirements.

You can find all the blower data in:

- Bulletin / Info Guide 610.

Follow these steps:

1. Calculate the outlet pressure:
When you calculate the outlet pressure of the blower, you must calculate the total of these pressures:
 - the static air pressure required at the burner
 - the total pressure drops in the piping
 - the total of the pressure drops across the valves
 - the pressure in the radiant or immersion tube (suction or pressurized)
 - recommend safety margin of 10%
2. Calculate the required flow:
The blower output is the air flow delivered under standard atmospheric conditions. It must be enough to feed all the burners in the system at high fire. Combustion air blowers are normally rated in terms of standard cubic feet per hour (scfh) of air.

An example calculation follows the information tables below:

Description	Unit of Measure	Formula Symbol
Total system heat input	BTU/hr	Q
Number of burners	-	-
Type of fuel	-	-
Gross heating value of fuel	BTU/ft ³	q
Desired excess air percentage (Typical excess air percentage @ high fire is 15%)	percent	%
Air/Gas ratio (Fuel specific, see table below)	-	
Air flow	scfh	V _{air}
Gas flow	scfh	V _{gas}

Table 3.5 Fuel Gas Heating Values

Fuel Gas	Stoichiometric* Air/Gas Ratio σ (ft ³ _{air} / ft ³ _{gas})	Gross Heating Value q (BTU/ft ³)
Natural Gas (Birmingham, AL)	9.41	1,002
Propane	23.82	2,572
Butane	30.47	3,225

*Stoichiometric: No excess air. The precise amount of air and gas are present for complete combustion.

Example Blower Calculation

"A batch furnace has been designed and requires a heat input of 2,900,000 Btu/h. It has been decided to provide the required heat input with four burners operating on natural gas using 15% excess air."

Calculation example:

- a. Decide which TFB burner model is appropriate:

$$\frac{Q \text{ (total heat input) of } 2,900,000 \text{ BTU/hr}}{4 \text{ burners}} = 725,000 \text{ BTU/hr/burner}$$

- Select 4 Model TFB075 TFB burners based on the required heat input of 725,000 Btu/hr for each burner.

- b. Calculate required gas flow:

$$V_{gas} = \frac{Q}{q} = \frac{2,900,000 \text{ BTU/hr}}{1,002 \text{ BTU/ft}^3} = 2,894 \text{ ft}^3/\text{hr}$$

- Gas flow of 2,894 ft³/hr is required

- c. Calculate required stoichometric air flow:

$$V_{air-Stoichiometric} = \sigma \text{ air/gas ratio} \times V_{gas} = 9.41 \times 2,894 \text{ ft}^3/\text{hr} = 27,235 \text{ ft}^3/\text{hr}$$

- Stoichiometric air flow of 27,235 scfh required

- d. Calculate final blower air flow requirement based on the desired amount of excess air:

$$V_{air} = \left(\frac{1 + \text{excess air \%}}{\%} \right) \times V_{air-Stoichiometric} = (1 + 0.15) \times 27,235 \text{ ft}^3/\text{hr} = 31,320 \text{ ft}^3/\text{hr}$$

- For this example, final blower air flow requirement is 31,320 scfh at 15% excess air.

NOTE: It is common practice to add an additional 10% to the final blower air flow requirement as a safety margin.

- 3. Find the blower model number and motor horsepower (hp). With the output pressure and the specific flow, you can find the blower catalog number and the motor hp in Bulletin / Info Guide 610.

- 4. Eclipse Combustion recommends that you select a Totally Enclosed Fan Cooled (TEFC) motor.
- 5. Select the other parameters:
 - inlet filter or inlet grille
 - inlet size (frame size)
 - voltage, number of phases, frequency
 - blower outlet location, and rotation direction Clockwise (CW) or Counter Clockwise (CCW)

NOTE: The use of an inlet air filter is strongly recommended. The system will perform longer and the settings will be more stable.

NOTE: When selecting a 60 Hz Blower for use on 50 Hz, a pressure and capacity calculation is required. See Eclipse Combustion Engineering Guide (EFE 825)

The total selection information you should now have:

- blower model number
- motor hp
- motor enclosure (TEFC)
- voltage, number of phases, frequency
- rotation direction (CW or CCW)

Air Pressure Switch

The air pressure switch gives a signal to the monitoring system when there is not enough air pressure from the blower. You can find more information on pressure switches in:

- Blower Bulletin 610



- Eclipse Combustion supports NFPA regulations, which require the use of an air pressure switch in conjunction with other safety components, as a minimum standard for main gas safety shut-off systems.

Step 6: Main Gas Shut-Off Valve Train

Eclipse can help you design and obtain a main gas shut-off valve train that complies with the current safety standards. The shut-off valve train must comply with all the local safety standards set by the authorities that have jurisdiction. For details, please contact Eclipse.

NOTE: Eclipse supports NFPA regulations (two shut-off valves) as a minimum standard for main gas safety shut-off systems.

Step 7: Process Temperature Control System

The process temperature control system is used to control and monitor the temperature of the system. There is a wide variety of control and measuring equipment available. For details, please contact Eclipse.



Appendix

Conversion Factors

Metric to English

From	To	Multiply By
actual cubic meter/h (am ³ /h)	actual cubic foot/h (acfh)	35.31
normal cubic meter/h (Nm ³ /h)	standard cubic foot /h (scfh)	38.04
degrees Celsius (°C)	degrees Fahrenheit (°F)	(°C x 9/5) + 32
kilogram (kg)	pound (lb)	2.205
kilowatt (kW)	Btu/h	3415
meter (m)	foot (ft)	3.281
millibar (mbar)	inches water column ("w.c.)	0.402
millibar (mbar)	pounds/sq in (psi)	14.5 x 10 ⁻³
millimeter (mm)	inch (in)	3.94 x 10 ⁻²
MJ/Nm ³	Btu/ft ³ (standard)	26.86

Metric to Metric







From	To	Multiply By
kiloPascals (kPa)	millibar (mbar)	10
meter (m)	millimeter (mm)	1000
millibar (mbar)	kiloPascals (kPa)	0.1
millimeter (mm)	meter (m)	0.001



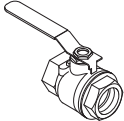
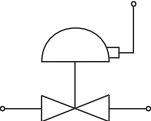
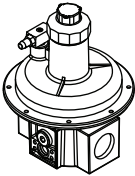
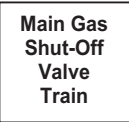

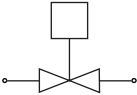
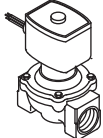



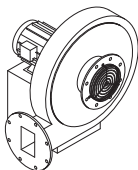

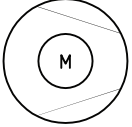
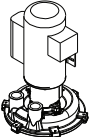
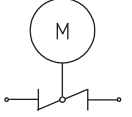
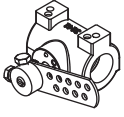
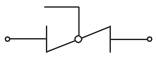
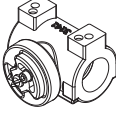
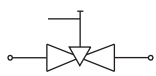

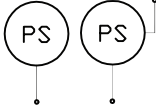
English to Metric

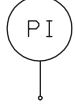
From	To	Multiply By
actual cubic foot/h (acfh)	actual cubic meter/h (am ³ /h)	2.832 x 10 ⁻²
standard cubic foot /h (scfh)	normal cubic meter/h (Nm ³ /h)	2.629 x 10 ⁻²
degrees Fahrenheit (°F)	degrees Celsius (°C)	(°F - 32) x 5/9
pound (lb)	kilogram (kg)	0.454
Btu/h	kilowatt (kW)	0.293 x 10 ⁻³
foot (ft)	meter (m)	0.3048
inches water column ("w.c.)	millibar (mbar)	2.489
pounds/sq in (psi)	millibar (mbar)	68.95
inch (in)	millimeter (mm)	25.4
Btu/ft ³ (standard)	MJ/Nm ³	37.2 x 10 ⁻³

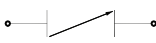

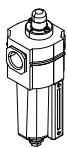
System Schematics

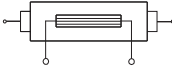
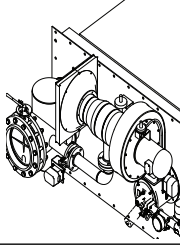
Symbol	Appearance	Name	Remarks	Bulletin/ Info Guide
		Gas Cock	Gas cocks are used to manually shut off the gas supply.	710
		Ratio Regulator	A ratio regulator is used to control the air/gas ratio. The ratio regulator is a sealed unit that adjusts the gas pressure in ratio with the air pressure. To do this, it measures the air pressure with a pressure sensing line, the impulse line. This impulse line is connected between the top of the ratio regulator and the burner body.	742
		Main Gas Shut-Off Valve Train	Eclipse strongly endorses NFPA as a minimum.	790/791
		Pilot Gas Valve Train	Eclipse strongly endorses NFPA as a minimum.	790/791
		Automatic Shut-Off Valve	Shut-off valves are used to automatically shut off the gas supply on a gas system or a burner.	760
		Orifice Meter	Orifice meters are used to measure flow.	930
		Combustion Air Blower	The combustion air blower provides the combustion air to the burner(s).	610

Symbol	Appearance	Name	Remarks	Bulletin/ Info Guide
		Hermetic Booster	Booster is used to increase gas pressure.	620
		Automatic Butterfly Valve	Automatic butterfly valves are typically used to set the output of the system.	720
		Manual Butterfly Valve	Manual butterfly valves are used to balance the air or gas flow at each burner.	720
		Adjustable Limiting Orifice	Adjustable limiting orifices are used for fine adjustment of gas flow.	728/730
		Pressure Switch	A switch activated by rise or fall in pressure. A manual reset version requires pushing a button to transfer the contacts when the pressure set point is satisfied.	840
		Pressure Gauge	A device to indicate pressure.	940
		Check Valve	A check valve permits flow only in one direction and is used to prevent back flow of gas.	780
		Strainer	A strainer traps sediment to prevent blockage of sensitive components downstream.	
		Flexible Connector	Flexible connectors isolate components from vibration, mechanical, and thermal stresses.	
		Heat Exchanger	Heat exchangers transfer heat from one medium to another.	500
		Pressure Taps	Pressure taps measure static pressure.	

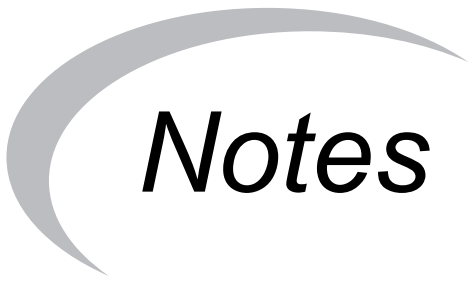

Notes

